

Technical data sheet

Fork photoelectric sensor

Part no.: 50146177
GS04B/N.1-40-M8.3



For illustration purposes only

Contents

- Technical data
- Dimensioned drawings
- Electrical connection
- Operation and display
- Part number code
- Notes
- Accessories



Technical data

Basic data

Series	04B
Principle of physics	Optical
Application	Detection of small parts

Characteristic parameters

MTTF	700.42 years
------	--------------

Optical data

Light source	LED, Red
Wavelength	660 nm
Transmitted-signal shape	Pulsed

Measurement data

Repeatability	0.02 mm
Minimum object diameter	0.3 mm

Electrical data

Protective circuit	Polarity reversal protection Short circuit protected
--------------------	---

Performance data

Supply voltage U_B	10 ... 30 V, DC
Residual ripple	0 ... 15 %, From U_B
Open-circuit current	0 ... 30 mA
Switching hysteresis	100 μ m

Outputs

Number of digital switching outputs	1 Piece(s)
-------------------------------------	------------

Switching outputs

Type	Digital switching output
Voltage type	DC
Switching current, max.	100 mA
Switching voltage	high: $\geq(U_B - 2V)$ low: $\leq 2 V$

Switching output 1

Assignment	Connection 1, pin 4
Switching element	Transistor, NPN
Switching principle	Light/dark switchable

Time behavior

Switching frequency	5,000 Hz
Response time	0.1 ms
Readiness delay	150 ms

Connection

Number of connections	1 Piece(s)
-----------------------	------------

Connection 1

Function	Signal OUT Voltage supply
Type of connection	Connector
Thread size	M8
Type	Male
Material	Metal
No. of pins	3 -pin

Mechanical data

Design	Fork
Mouth width	40 mm
Mouth depth	45 mm
Dimension (W x H x L)	10 mm x 60 mm x 70 mm
Housing material	Metal
Metal housing	Diecast zinc
Lens cover material	Glass
Net weight	84 g
Housing color	Black, RAL 9005
Type of fastening	Through-hole mounting

Operation and display

Type of display	LED
Number of LEDs	1 Piece(s)
Operational controls	270° potentiometer
Function of the operational control	Light/dark switching Sensitivity adjustment

Environmental data

Ambient temperature, operation	-25 ... 60 °C
--------------------------------	---------------

Certifications

Degree of protection	IP 67
Protection class	III
Approvals	c UL US
Standards applied	IEC 60947-5-2, DIN EN ISO 1389-1:2016 appendix C,D

Classification

Customs tariff number	85365019
ECLASS 5.1.4	27270909
ECLASS 8.0	27270909
ECLASS 9.0	27270909
ECLASS 10.0	27270909
ECLASS 11.0	27270909
ECLASS 12.0	27270909
ECLASS 13.0	27270909
ECLASS 14.0	27270909
ECLASS 15.0	27270909
ECLASS 16.0	27270909
ETIM 5.0	EC002720
ETIM 6.0	EC002720
ETIM 7.0	EC002720
ETIM 8.0	EC002720
ETIM 9.0	EC002720
ETIM 10.0	EC002720
UNSPSC 26.08	39121528

Dimensioned drawings

All dimensions in millimeters

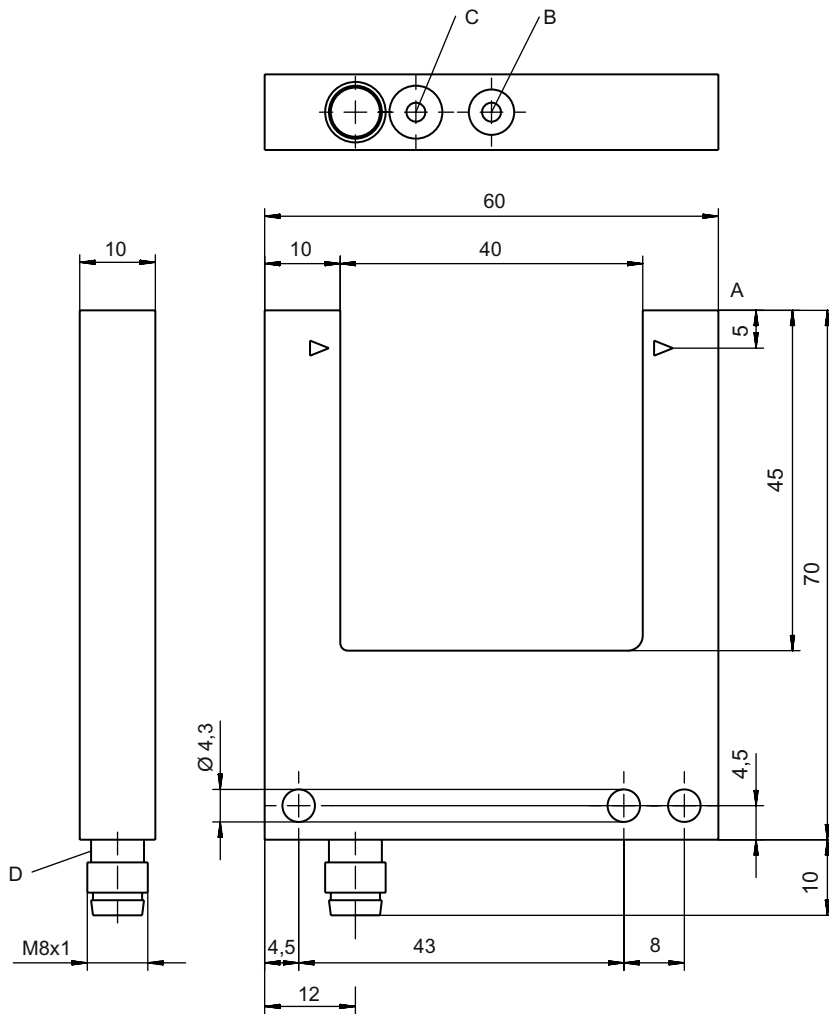

- A Optical axis
- B Sensitivity adjustment
- C Light/dark switching
- D LED indicator

Electrical connection

Connection 1

Function	Signal OUT
	Voltage supply
Type of connection	Connector
Thread size	M8
Type	Male
Material	Metal
No. of pins	3 -pin

Pin	Pin assignment
1	V+
3	GND
4	OUT 1

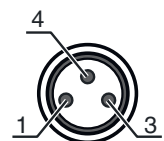

Operation and display

LED	Display	Meaning
1	Yellow, continuous light	Switching output/switching state active

Part number code

Part designation: **AAA04B/C.D-EEE-FFF**

AAA04B	Operating principle / construction GS04B: Optical fork sensor, LED light source GSL04B: Optical fork sensor, laser light source
C	Switching output / Function P: PNP transistor output, dark switching N: NPN transistor output, dark switching 1: IO-Link / light switching (NPN) / dark switching (PNP)
D	Equipment 1: 270° potentiometer
EEE	Mouth width [mm] Mouth width in millimeters
FFF	Electrical connection M8.3: M8 connector, 3-pin (plug)

Note	
	A list with all available device types can be found on the Leuze website at www.leuze.com .

Notes

⚠ Observe intended use!	
	<ul style="list-style-type: none"> This product is not a safety sensor and is not intended as personnel protection. The product may only be put into operation by competent persons. Only use the product in accordance with its intended use.

Accessories

Connection technology - Connection cables

	Part no.	Designation	Article	Description
	50130832	KD U-M8-3A-V1-050	Connection cable	Application: Chemical resistant Connection 1: Connector, M8, Axial, Female, 3 -pin Connector, LED: No Connection 2: Open end Shielded: No Cable length: 5,000 mm Sheathing material: PVC
	50130862	KD U-M8-3W-V1-050	Connection cable	Application: Chemical resistant Connection 1: Connector, M8, Angled, Female, 3 -pin Connector, LED: No Connection 2: Open end Shielded: No Cable length: 5,000 mm Sheathing material: PVC

Accessories

Note



🔗 A list with all available accessories can be found on the Leuze website in the Download tab of the article detailed page.