

## Technical data sheet

### Line profile sensor

Part no.: 50150145

LES 36/PB.30

#### Contents

- Technical data
- Dimensioned drawings
- Electrical connection
- Diagrams
- Operation and display
- Notes
- Accessories



For illustration purposes only



CDRH Ethernet

## Technical data

### Basic data

Series	36
Contains	LxSsoft configuration software
Application	3D object detection Object measurement

### Special version

Special version	Polarization filter Synchronization input
-----------------	----------------------------------------------

### Optical data

Light source	Laser, Red
Laser class	2M

### Measurement data

X-axis measurement range	150 ... 600 mm
Measurement range z-axis	200 ... 800 mm
Resolution of x-axis	1 ... 1.7 mm
Resolution of z-axis	1 ... 3 mm
Repeatability of Z-axis, relative to measurement distance, note	Reflectivity 90%, identical object, identical environment conditions, measurement object $\leq 50 \times 50 \text{ mm}^2$
Measurement time	10ms
Linearity of Z-axis, relative to measurement distance	$\pm 1,0\%$
Minimum object size, x-axis	2 ... 3 mm
Minimum object size, z-axis	2 ... 6 mm
Black/white behavior	1 %, 6 ... 90% diffuse reflectance

### Electrical data

<b>Performance data</b>	
Supply voltage $U_B$	18 ... 30 V, DC
<b>Inputs</b>	
Number of activation inputs	1 Piece(s)
Number of digital switching inputs	2 Piece(s)
<b>Outputs</b>	
Number of digital switching outputs	2 Piece(s)

#### Switching outputs

##### Switching output 1

Switching element	Transistor
Function	Operational readiness

##### Switching output 2

Switching element	Transistor
Function	Cascading

### Interface

Type	PROFIBUS DP, Ethernet
------	-----------------------

### Connection

Number of connections	3 Piece(s)
-----------------------	------------

### Connection 1

Function	Signal IN Signal OUT Voltage supply
Type of connection	Connector
Thread size	M12
Type	Male
Material	Metal
No. of pins	8 -pin
Encoding	A-coded

### Connection 2

Function	Configuration interface Data interface
Type of connection	Connector
Thread size	M12
Type	Female
Material	Metal
No. of pins	4 -pin
Encoding	D-coded

### Connection 4

Function	PROFIBUS IN PROFIBUS OUT
Type of connection	Connector
Thread size	M12
Type	Female
Material	Metal
No. of pins	5 -pin
Encoding	B-coded

### Mechanical data

Dimension (W x H x L)	56 mm x 160 mm x 74 mm
Housing material	Metal Plastic
Metal housing	Aluminum
Lens cover material	Glass
Net weight	620 g

### Environmental data

Ambient temperature, operation	-30 ... 50 °C
Ambient temperature, storage	-30 ... 70 °C

### Certifications

Degree of protection	IP 67
Protection class	III, VDE
Approvals	c UL US
Standards applied	IEC/EN 60947-5-2
US patents	US 8,928,894 B

## Technical data

Customs tariff number	90318020
ECLASS 5.1.4	27280190
ECLASS 8.0	27280190
ECLASS 9.0	27280190
ECLASS 10.0	27280190
ECLASS 11.0	27280190
ECLASS 12.0	27280190
ECLASS 13.0	27280190
ECLASS 14.0	27280190
ECLASS 15.0	27280190
ECLASS 16.0	27280190
ETIM 5.0	EC001825
ETIM 6.0	EC001825
ETIM 7.0	EC001825
ETIM 8.0	EC001825
ETIM 9.0	EC001825
ETIM 10.0	EC001825
UNSPSC 26.08	43211701

## Dimensioned drawings

All dimensions in millimeters

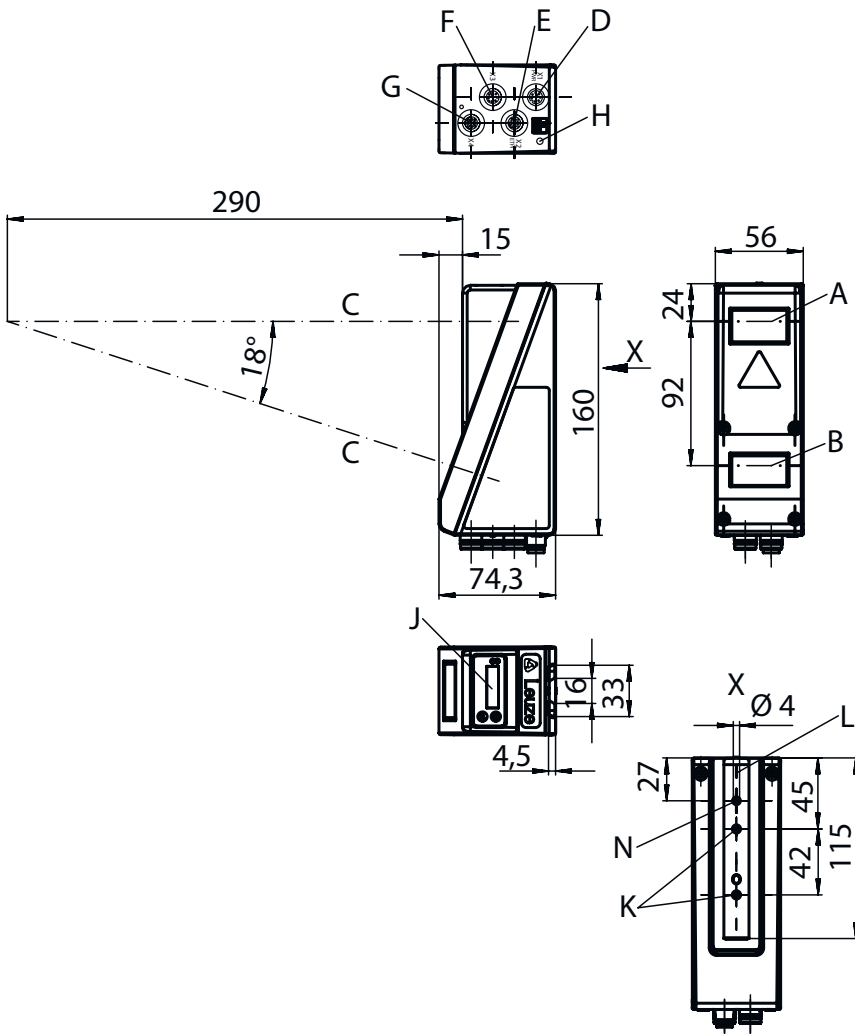

- A Transmitter
- B Receiver
- C Optical axis
- D, E, F, G X1-X4 connections
- H FE screw
- J OLED display and membrane keyboard
- K M4 thread (4.5 mm deep)
- L Support for mounting system

## Electrical connection

### Connection 1

### PWR

Function	Signal IN
	Signal OUT
	Voltage supply
Type of connection	Connector
Thread size	M12
Type	Male
Material	Metal
No. of pins	8 -pin
Encoding	A-coded

## Electrical connection

Pin	Pin assignment
1	V+
2	IN ACTIVATE
3	GND
4	OUT 1 / Operational readiness
5	Trigger IN
6	OUT 2
7	n.c.
8	n.c.



Connection 2	ETH
Function	Configuration interface Data interface
Type of connection	Connector
Thread size	M12
Type	Female
Material	Metal
No. of pins	4 -pin
Encoding	D-coded

Pin	Pin assignment
1	Tx+
2	Rx+
3	Tx-
4	Rx-

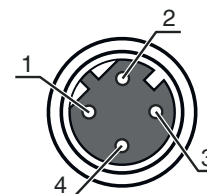

Connection 4	
Function	PROFIBUS IN PROFIBUS OUT
Type of connection	Connector
Thread size	M12
Type	Female
Material	Metal
No. of pins	5 -pin
Encoding	B-coded

Pin	Pin assignment
1	VP
2	A (N)
3	GND
4	B (P)
5	FE

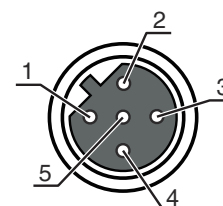

# Diagrams

## Measurement range

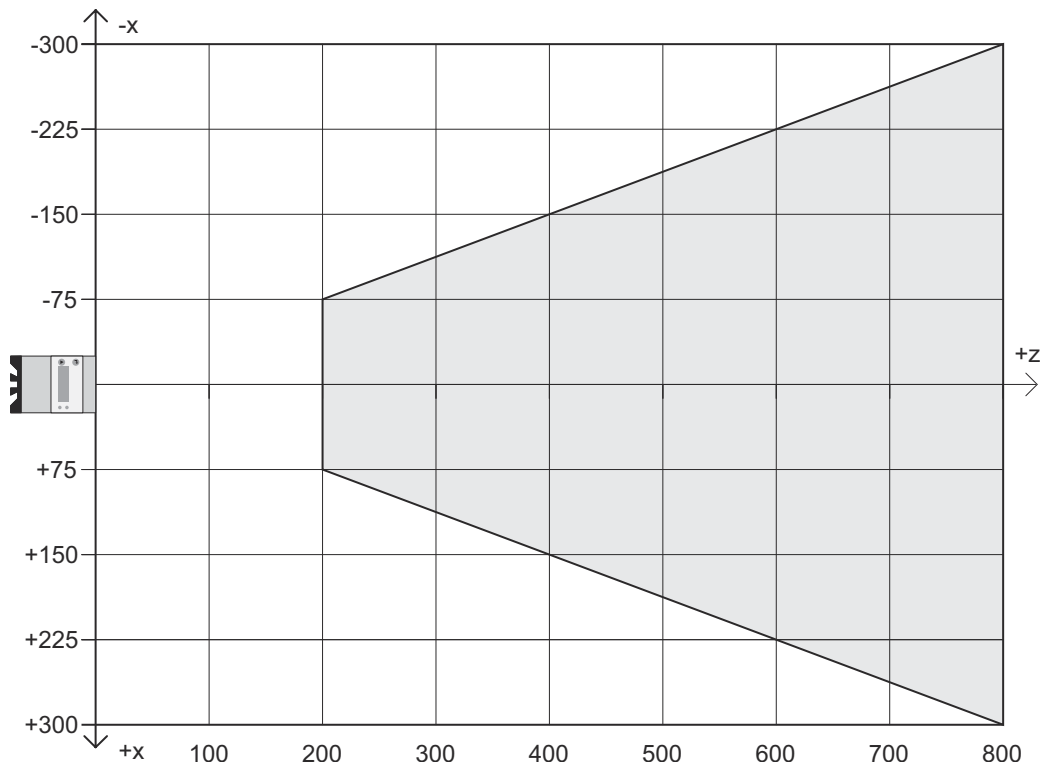

X Line length in mm  
 Z Object distance

## Operation and display

LED	Display	Meaning
1	Green, continuous light	Operational readiness
	Off	No supply voltage
2	Yellow, continuous light	Ethernet connection is established
	Yellow, flashing	Data transmission active
	Off	No data transmission

## Notes

**Observe intended use!**

	<ul style="list-style-type: none"> <li>⌘ This product is not a safety sensor and is not intended as personnel protection.</li> <li>⌘ The product may only be put into operation by competent persons.</li> <li>⌘ Only use the product in accordance with its intended use.</li> </ul>
--	---------------------------------------------------------------------------------------------------------------------------------------------------------------------------------------------------------------------------------------------------------------------------------------

## Notes

### NOTE



↪ For UL applications, use is only permitted in Class 2 circuits in accordance with the NEC (National Electric Code).



### ATTENTION! LASER RADIATION – CLASS 2M LASER PRODUCT



#### Do not stare into beam or expose users of telescopic optics!

The device satisfies the requirements of IEC 60825-1:2014 / EN 60825-1:2014+A11:2021 safety regulations for a product of **laser class 2M** and complies with U.S. 21 CFR 1040.10 except for conformance with IEC 60825-1 Ed. 3., as described in Laser Notice No. 56, dated May 8, 2019.

- ↪ Never look directly into the laser beam or in the direction of reflected laser beams! If you look into the beam path over a longer time period, there is a risk of injury to the retina.
- ↪ Do not point the laser beam of the device at persons!
- ↪ Interrupt the laser beam using a non-transparent, non-reflective object if the laser beam is accidentally directed towards a person.
- ↪ When mounting and aligning the device, avoid reflections of the laser beam off reflective surfaces!
- ↪ CAUTION! The use of operating and adjusting devices other than those specified here or the carrying out of differing procedures may lead to dangerous exposure to radiation! The use of optical instruments or devices (e.g., magnifying glasses, binoculars) in combination with the device increases the danger of eye damage.
- ↪ Observe the applicable statutory and local laser protection regulations.
- ↪ The device must not be tampered with and must not be changed in any way.  
There are no user-serviceable parts inside the device.  
There are no user-serviceable parts inside the device.  
Repairs must only be performed by Leuze electronic GmbH + Co. KG.
- ↪ The device emits a divergent, pulsed laser beam. For laser power, pulse duration and wavelength, see technical data.

## Accessories

### Connection technology - Connection cables

	Part no.	Designation	Article	Description
	50135128	KD S-M12-8A-P1-050	Connection cable	Application: Oil and lubricant resistant Connection 1: Connector, M12, Axial, Female, A-coded, 8 -pin Connector, LED: No Connection 2: Open end Shielded: Yes Cable length: 5,000 mm Sheathing material: PUR

### Connection technology - Interconnection cables

	Part no.	Designation	Article	Description
	50135081	KSS ET-M12-4A-RJ45-A-P7-050	Interconnection cable	Application: Oil and lubricant resistant Suitable for interface: Ethernet Connection 1: Connector, M12, Axial, Male, D-coded, 4 -pin Connection 2: RJ45 Shielded: Yes Cable length: 5,000 mm Sheathing material: PUR

## Accessories

### Connection technology - Adapters

	Part no.	Designation	Article	Description
	50109834	KDS BUS OUT M12-T-5P	Adapter	Suitable for: MultiNet Plus, PROFIBUS DP Number of connections: 3 Piece(s) Connection 1: Connector, M12, Axial, Male, B-coded, 5 -pin Connection 2: Connector, M12, Axial, Female, B-coded, 5 -pin Connection 3: Connector, M12, Axial, Male, B-coded, 5 -pin

### Mounting technology - Rod mounts

	Part no.	Designation	Article	Description
	50121435	BT 56 - 1	Mounting device	Functions: Static applications Design of mounting device: Mounting system Fastening, at system: For 12 mm rod, For 14 mm rod, For 16 mm rod Mounting bracket, at device: Clampable Material: Metal Tightening torque of the clamping jaws: 8 N·m

### Services

	Part no.	Designation	Article	Description
	S981001	CS10-S-110	Start-up support	Details: Performed at location of customer's choosing, duration: max. 10 hours. Conditions: Devices and connection cables are already mounted, price not including travel costs and, if applicable, accommodation expenses.
	S981005	CS10-T-110	Product training	Details: Location and content to be agreed upon, duration: max. 10 hours. Conditions: Price not including travel costs and, if applicable, accommodation expenses.

#### Note



A list with all available accessories can be found on the Leuze website in the Download tab of the article detailed page.