

Technical data sheet

Safety sensor set

Part no.: 68602027

MLC520-S-24-270



Contents

- Technical data
- Dimensioned drawings
- Electrical connection
- Part number code
- Accessories



Technical data

Basic data

Series	MLC 520S
Device type	Set (transmitter and receiver)
Contains	4x BT-MLC-S-C mounting brackets 4x BT-MLC-S-O mounting brackets
Application	Hand protection

Functions

Functions	Automatic start/restart Contactor monitoring (EDM) Start/restart interlock (RES)
-----------	--

Characteristic parameters

Type	4, IEC/EN IEC 61496
SIL	3, IEC 61508
SIL	3, IEC/EN IEC 62061
Performance Level (PL)	e, EN ISO 13849-1
PFH _D	2,64E-09 per hour
Mission time T _M	20 years, EN ISO 13849-1
Category	4, EN ISO 13849

Protective field data

Resolution	24 mm
Protective field height	270 mm
Operating range	0.2 ... 6 m

Optical data

Number of beams	14 Piece(s)
Synchronization	Optical between transmitter and receiver
Light source	LED, Infrared
Wavelength	850 nm
Transmitted-signal shape	Pulsed
LED risk group	Exempt group (in acc. with EN 62471:2008)

Electrical data

Protective circuit	Overvoltage protection Short circuit protected
--------------------	---

Performance data

Supply voltage U _B	24 V, DC, -20 ... 20 %
-------------------------------	------------------------

Outputs

Number of safety-related switching outputs (OSSDs)	2 Piece(s)
--	------------

Safety-related switching outputs

Type	Safety-related switching output OSSD
Switching voltage high, min.	18 V
Switching voltage low, max.	2.5 V
Switching voltage, type.	22.5 V
Voltage type	DC
Load inductivity	2,000 µH
Load capacity	1 µF
Residual current, max.	200 mA
Residual current, type.	2 mA

Safety-related switching output 1

Assignment	Receiver device connection, pin 2
Switching element	Transistor, PNP

Safety-related switching output 2

Assignment	Receiver device connection, pin 4
Switching element	Transistor, PNP

Time behavior

Response time	8 ms
---------------	------

Connection

Number of connections	2 Piece(s)
-----------------------	------------

Connection 1

Function	Transmitter device connection
Type of connection	Cable with connector
Cable length	160 mm
Sheathing material	PUR
Thread size	M12
Material	Plastic
No. of pins	5 -pin

Connection 2

Function	Receiver device connection
Type of connection	Cable with connector
Cable length	160 mm
Sheathing material	PUR
Thread size	M12
Material	Plastic
No. of pins	5 -pin

Mechanical data

Dimension (W x H x L)	15.4 mm x 270 mm x 32.6 mm
Housing material	Metal
Metal housing	Aluminum
Lens cover material	Plastic / PMMA
Material of end caps	Plastic
Net weight	1,400 g
Housing color	Yellow, RAL 1021
Type of fastening	C-shaped mounting bracket L-shaped mounting bracket O-shaped mounting bracket

Environmental data

Ambient temperature, operation	-10 ... 55 °C
Ambient temperature, storage	-30 ... 70 °C
Relative humidity (non-condensing)	15 ... 95 %

Certifications

Degree of protection	IP 65
Protection class	III
Approvals	TÜV Süd
Vibration resistance	50 m/s ²
Shock resistance	98.1 m/s ²
US patents	US 6,418,546 B

Technical data

Customs tariff number	85365019
ECLASS 5.1.4	27272704
ECLASS 8.0	27272704
ECLASS 9.0	27272704
ECLASS 10.0	27272704
ECLASS 11.0	27272704
ECLASS 12.0	27272704
ECLASS 13.0	27272704
ECLASS 14.0	27272704
ECLASS 15.0	27272704
ECLASS 16.0	27272704
ETIM 5.0	EC002549
ETIM 6.0	EC002549
ETIM 7.0	EC002549
ETIM 8.0	EC002549
ETIM 9.0	EC002549
ETIM 10.0	EC002549
UNSPSC 26.08	46171620

Dimensioned drawings

All dimensions in millimeters

Dimensions of transmitter and receiver

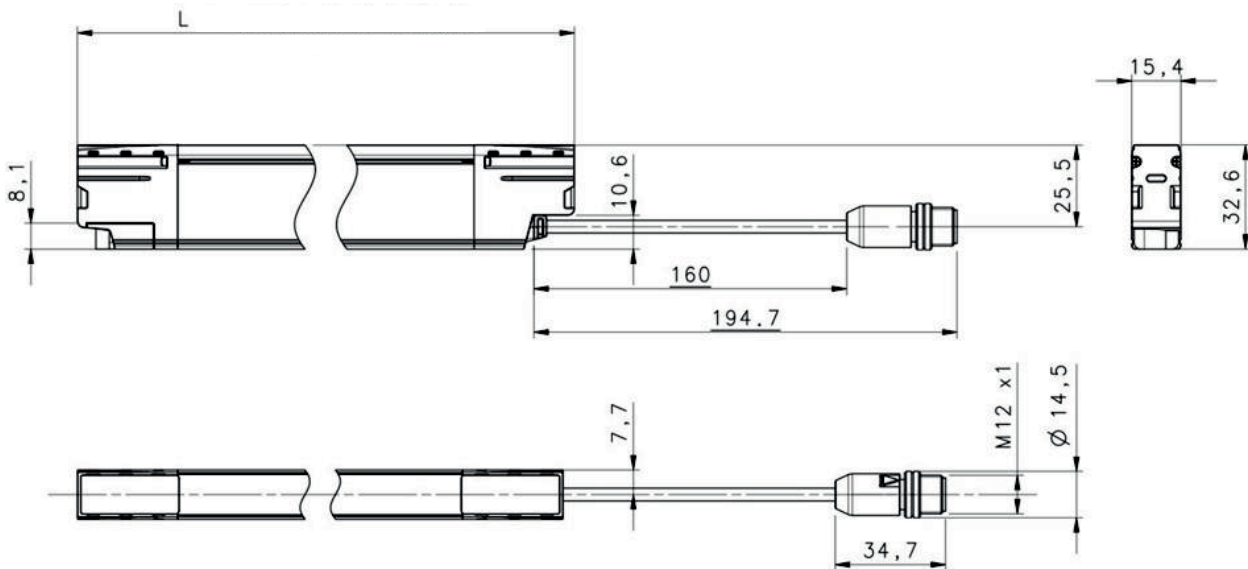

L Length/protective field height

Electrical connection

Connection 1		Transmitter
Function		Transmitter device connection
Type of connection		Cable with connector
Cable length		160 mm
Sheathing material		PUR
Cable color		Black

Electrical connection

Connection 1

Transmitter

Thread size	M12
Type	Male
Material	Plastic
No. of pins	5 -pin
Encoding	A-coded
Connector housing	FE/SHIELD

Pin	Pin assignment	Conductor color
1	+24 V DC	Brown
2	RESTART SELECTION	White
3	0 V	Blue
4	n.c.	Black
5	RESTART SELECTION	Gray



Connection 2

Receiver

Function	Receiver device connection
Type of connection	Cable with connector
Cable length	160 mm
Sheathing material	PUR
Cable color	Black
Thread size	M12
Type	Male
Material	Plastic
No. of pins	5 -pin
Encoding	A-coded
Connector housing	FE/SHIELD

Pin	Pin assignment	Conductor color
1	EDM	Brown
2	OSSD1	White
3	0 V	Blue
4	OSSD2	Black
5	EDM FBK/SELECTION	Gray



Part number code

Part designation: MLCxxx-ooo-aa-hhhh

MLC Safety light curtain

xxx	Series 520: MLC 520S
aa	Resolution 14: 14 mm 24: 24 mm
hhhh	Protective field height 150 ... 1200: from 150 mm to 1200 mm
ooo	Option S: Slimline version

Note



A list with all available device types can be found on the Leuze website at www.leuze.com.

Accessories

Connection technology - Connection cables

	Part no.	Designation	Article	Description
	50133841	KD U-M12-5A-P1-050	Connection cable	Application: Oil and lubricant resistant Connection 1: Connector, M12, Axial, Female, A-coded, 5 -pin Connector, LED: No Connection 2: Open end Shielded: No Cable length: 5,000 mm Sheathing material: PUR

Services

	Part no.	Designation	Article	Description
	S981050	CS40-I-140	Safety inspection	Details: Checking of a safety light barrier application in accordance with current standards and guidelines. Inclusion of the device and machine data in a database, production of a test log per application. Conditions: It must be possible to stop the machine, support provided by customer's employees and access to the machine for Leuze employees must be ensured.
	S981046	CS40-S-140	Start-up support	Details: For safety devices including stopping time measurement and initial inspection. Conditions: Devices and connection cables are already mounted, price not including travel costs and, if applicable, accommodation expenses.

Note



A list with all available accessories can be found on the Leuze website in the Download tab of the article detailed page.