

## Technical data sheet Stationary bar code reader

Part no.: 50116368

BCL 308i OF 100



For illustration purposes only

### Contents

- Technical data
- Dimensioned drawings
- Electrical connection
- Diagrams
- Operation and display
- Part number code
- Notes
- Accessories



Ethernet



UK  
CA

## Technical data

### Basic data

Series	BCL 300i
--------	----------

### Functions

Functions	Alignment mode
	AutoConfig
	AutoControl
	AutoReflAct
	Code fragment technology
	LED indicator
	Reference code comparison

### Characteristic parameters

MTTF	110 years
------	-----------

### Read data

Code types, readable	2/5 Interleaved
	Codabar
	Code 128
	Code 39
	Code 93
	EAN 8/13
	GS1 Databar Expanded
	GS1 Databar Limited
	GS1 Databar Omnidirectional
	UPC
Scanning rate, typical	1,000 scans/s
Bar codes per reading gate, max. number	64 Piece(s)

### Optical data

Reading distance	80 ... 455 mm
Light source	Laser, Red
Wavelength	655 nm
Laser class	1, IEC/EN 60825-1:2014
Transmitted-signal shape	Continuous
Modulus size	0.3 ... 0.5 mm
Reading method	Oscillating-mirror scanner
Beam deflection	Via rotating polygon wheel + stepping motor with mirror
Light beam exit	Zero position at side at angle less than 90°
Oscillating mirror frequency	10 Hz
Max. swivel angle	20 °

### Electrical data

Protective circuit	Polarity reversal protection
<b>Performance data</b>	
Supply voltage $U_B$	18 ... 30 V, DC
Power consumption, max.	9 W
<b>Inputs/outputs selectable</b>	
Output current, max.	60 mA
Number of inputs/outputs selectable	2 Piece(s)
Input current, max.	8 mA

### Interface

Type	Ethernet
------	----------

### Ethernet

Architecture	Client
	Server
Address assignment	DHCP
	Manual address assignment
Transmission speed	10 Mbit/s
	100 Mbit/s
Function	Process
Switch functionality	Integrated
Transmission protocol	TCP/IP, UDP

### Service interface

Type	USB 2.0
------	---------

### USB

Function	Configuration via software
	Service

### Connection

Number of connections	1 Piece(s)
-----------------------	------------

### Connection 1

Function	BUS IN
	Connection to device
	Data interface
	PWR / SW IN / OUT
	Service interface
Type of connection	Plug connector, It is essential to use a connection unit when commissioning the device.
No. of pins	32 -pin
Type	Male

### Mechanical data

Design	Cubic
Dimension (W x H x L)	125 mm x 58 mm x 110 mm
Housing material	Metal
Metal housing	Diecast aluminum
Lens cover material	Glass
Net weight	580 g
Housing color	Red
	Silver
Type of fastening	Dovetail grooves
	Fastening on back
	Via optional mounting device

### Operation and display

Type of display	LED
Number of LEDs	2 Piece(s)
Type of configuration	Via web browser

### Environmental data

Ambient temperature, operation	0 ... 40 °C
Ambient temperature, storage	-20 ... 70 °C
Relative humidity (non-condensing)	0 ... 90 %

## Technical data

### Certifications

Degree of protection	IP 65
Protection class	III
Approvals	c UL US
Test procedure for EMC in accordance with standard	EN 55022 EN 61000-4-2, -3, -4, -6
Test procedure for shock in accordance with standard	IEC 60068-2-27, test Ea
Test procedure for continuous shock in accordance with standard	IEC 60068-2-29, test Eb
Test procedure for vibration in accordance with standard	IEC 60068-2-6, test Fc

### Classification

Customs tariff number	84719000
ECLASS 5.1.4	27280102
ECLASS 8.0	27280102
ECLASS 9.0	27280102
ECLASS 10.0	27280102
ECLASS 11.0	27280102
ECLASS 12.0	27280102
ECLASS 13.0	27280102
ECLASS 14.0	27280102
ECLASS 15.0	27280102
ECLASS 16.0	27280102
ETIM 5.0	EC002550
ETIM 6.0	EC002550
ETIM 7.0	EC002550
ETIM 8.0	EC002550
ETIM 9.0	EC002550
ETIM 10.0	EC002550
UNSPSC 26.08	43211701

# Dimensioned drawings

All dimensions in millimeters

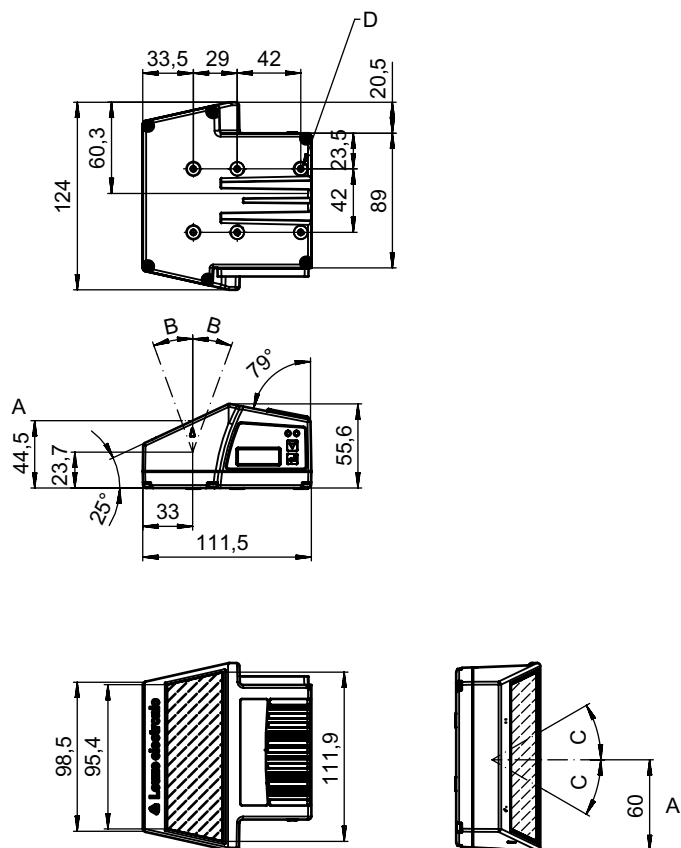

- A Optical axis
- B Swivel angle of the laser beam:  $\pm 20^\circ$
- C Deflection angle of the laser beam:  $\pm 30^\circ$
- D M4 thread (5 mm deep)

## Electrical connection

### Connection 1

Function	BUS IN Connection to device Data interface PWR / SW IN / OUT Service interface
Type of connection	Plug connector
Type of connection	It is essential to use a connection unit when commissioning the device.
No. of pins	32 -pin
Type	Male

# Diagrams

## Reading field curve



x Reading field distance [mm]

y Reading field width [mm]

# Diagrams

## Lateral reading field curve



x Reading field distance [mm]  
 y Reading field height [mm]

## Operation and display

LED	Display	Meaning
1 PWR	Green, flashing	Device ok, initialization phase
	Green, continuous light	Device OK
	Green, briefly off - on	Reading successful
	Green, briefly off - briefly red - on	Reading not successful
	Orange, continuous light	Service mode
	Red, flashing	Device OK, warning set
	Red, continuous light	Error, device error
2 BUS	Green, flashing	Initialization
	Green, continuous light	Bus operation ok
	Red, flashing	Communication error
	Red, continuous light	Bus error

# Part number code

Part designation: **BCL XXXX YYZ AAA BB CCCC**

<b>BCL</b>	<b>Operating principle</b> BCL: bar code reader
<b>XXXX</b>	<b>Series/interface (integrated fieldbus technology)</b> 300i: RS 232 / RS 422 (stand-alone) 301i: RS 485 (multiNet slave) 304i: PROFIBUS DP 308i: EtherNet TCP/IP, UDP 338i: EtherCAT 348i: PROFINET RT 358i: EtherNet/IP
<b>YY</b>	<b>Scanning principle</b> S: line scanner (single line) R1: line scanner (raster) O: oscillating-mirror scanner (oscillating mirror)
<b>Z</b>	<b>Optics</b> N: High Density (close) M: Medium Density (medium distance) F: Low Density (remote) L: Long Range (very large distances) J: ink-jet (depending on the application)
<b>AAA</b>	<b>Beam exit</b> 100: lateral 102: front
<b>BB</b>	<b>Special equipment</b> D: With display H: with heating DH: optionally with display and heating P: plastic exit window
<b>CCCC</b>	<b>Functions</b> F007: optimized process data structure F099: OPC-UA function

**Note**



A list with all available device types can be found on the Leuze website at [www.leuze.com](http://www.leuze.com).

## Notes

 **Observe intended use!**



- ⌘ This product is not a safety sensor and is not intended as personnel protection.
- ⌘ The product may only be put into operation by competent persons.
- ⌘ Only use the product in accordance with its intended use.

 **ATTENTION! LASER RADIATION – CLASS 1 LASER PRODUCT**





The device satisfies the requirements of IEC/EN 60825-1:2014 safety regulations for a product of **laser class 1** and complies with 21 CFR 1040.10 except for conformance with IEC 60825-1 Ed. 3., as described in Laser Notice No. 56, dated May 8, 2019.

- ⌘ Observe the applicable statutory and local laser protection regulations.
- ⌘ The device must not be tampered with and must not be changed in any way.  
There are no user-serviceable parts inside the device.  
Repairs must only be performed by Leuze electronic GmbH + Co. KG.

## Accessories



### Connection technology - Connection cables

	Part no.	Designation	Article	Description
	50132079	KD U-M12-5A-V1-050	Connection cable	Application: Chemical resistant Connection 1: Connector, M12, Axial, Female, A-coded, 5 -pin Connector, LED: No Connection 2: Open end Shielded: No Cable length: 5,000 mm Sheathing material: PVC
	50135074	KS ET-M12-4A-P7-050	Connection cable	Application: Oil and lubricant resistant Suitable for interface: Ethernet Connection 1: Connector, M12, Axial, Male, D-coded, 4 -pin Connector, LED: No Connection 2: Open end Shielded: Yes Cable length: 5,000 mm Sheathing material: PUR

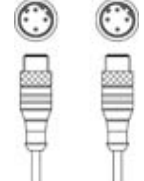
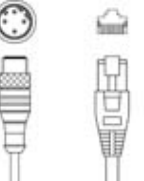

### Connection technology - Interconnection cables

	Part no.	Designation	Article	Description
	50117011	KB USB A - USB miniB	Service line	Application: Oil and lubricant resistant Suitable for interface: USB Connection 1: USB Connection 2: USB Shielded: Yes Cable length: 1,500 mm Sheathing material: PVC
	50137078	KSS ET-M12-4A-M12-4A-P7-050	Interconnection cable	Application: Oil and lubricant resistant Suitable for interface: Ethernet Connection 1: Connector, M12, Axial, Male, D-coded, 4 -pin Connection 2: Connector, M12, Axial, Male, D-coded, 4 -pin Shielded: Yes Cable length: 5,000 mm Sheathing material: PUR
	50135081	KSS ET-M12-4A-RJ45-A-P7-050	Interconnection cable	Application: Oil and lubricant resistant Suitable for interface: Ethernet Connection 1: Connector, M12, Axial, Male, D-coded, 4 -pin Connection 2: RJ45 Shielded: Yes Cable length: 5,000 mm Sheathing material: PUR

### Connection technology - Connection boxes

	Part no.	Designation	Article	Description
	50131255 *	ME 308 103	Connection unit	Suitable for: BCL 308i Number of connections: 4 Piece(s) Connection: Cable with connector, M12, 900 mm
	50131254 *	ME 308 104	Connection unit	Suitable for: BCL 308i Number of connections: 5 Piece(s) Connection: Cable with connector, M12, 900 mm

## Accessories

	Part no.	Designation	Article	Description
	50116466 *	MK 308	Connection unit	Suitable for: BCL 308i Number of connections: 4 Piece(s) Connection: Terminal
	50114823 *	MS 308	Connection unit	Suitable for: BCL 308i Number of connections: 4 Piece(s) Connection: Connector, M12

\* Necessary accessories, please order separately

## Mounting technology - Mounting brackets

	Part no.	Designation	Article	Description
	50121433	BT 300 W	Mounting device	Contains: 4x M4 x 10 screw, 2x M6 x 10 screws, 4x M3 x 8 screw Design of mounting device: Angle, L-shape Fastening, at system: Through-hole mounting Mounting bracket, at device: Screw type Type of mounting device: Adjustable Material: Metal

## Mounting technology - Rod mounts

	Part no.	Designation	Article	Description
	50121435	BT 56 - 1	Mounting device	Functions: Static applications Design of mounting device: Mounting system Fastening, at system: For 12 mm rod, For 14 mm rod, For 16 mm rod Mounting bracket, at device: Clampable Material: Metal Tightening torque of the clamping jaws: 8 N·m



## Mounting technology - Other

	Part no.	Designation	Article	Description
	50124941	BTU 0300M-W	Mounting device	Fastening, at system: Through-hole mounting Mounting bracket, at device: Clampable, Groove mounting, Suited for M4 screws Material: Metal Shock absorber: No

## Services

	Part no.	Designation	Article	Description
	S981020	CS30-E-212	Hourly rate	Details: Compilation of the application data, selection and suggestion of suitable sensor system, drawing prepared as assembly sketch. Conditions: Completed questionnaire or project specifications with a description of the application have been provided.

## Accessories

	Part no.	Designation	Article	Description
	S981014	CS30-S-110	Start-up support	Details: Performed at location of customer's choosing, duration: max. 10 hours. Conditions: Devices and connection cables are already mounted, price not including travel costs and, if applicable, accommodation expenses.
	S981019	CS30-T-110	Product training	Details: Location and content to be agreed upon, duration: max. 10 hours. Conditions: Price not including travel costs and, if applicable, accommodation expenses.
	S981021	CS30-V-212	Hourly rate	Details: REA evaluation with creation of a test report, evaluation of the code quality. Conditions: Original bar codes to be provided by the client.

### Note



A list with all available accessories can be found on the Leuze website in the Download tab of the article detailed page.