

## Technical data sheet

### Single light beam safety device receiver

Part no.: 66536002

MLD510-R1LE/A

#### Contents

- Technical data
- Dimensioned drawings
- Electrical connection
- Operation and display
- Suitable transmitters
- Part number code
- Accessories



For illustration purposes only



## Technical data

### Basic data

Series	MLD 500
--------	---------

### Special version

Special version	Connection socket for external muting indicator
	Reflective element for laser alignment aid

### Functions

Functions	Automatic restart
-----------	-------------------

### Characteristic parameters

Type	4, IEC/EN 61496
SIL	3, IEC 61508
SILCL	3, IEC/EN 62061
Performance Level (PL)	e, EN ISO 13849-1:2008
MTTF <sub>d</sub>	204 years, EN ISO 13849-1
PFH <sub>D</sub>	6.6E-09 per hour
Mission time T <sub>M</sub>	20 years, EN ISO 13849-1
Category	4, EN ISO 13849

### Electrical data

Protective circuit	Overvoltage protection
	Short circuit protected

#### Performance data

Supply voltage U <sub>B</sub>	26.5 ... 31.6 V
Current consumption from AS-i circuit	50 mA

#### Outputs

Number of digital switching outputs	1 Piece(s)
-------------------------------------	------------

#### Switching outputs

Switching voltage high, min.	18.2 V
Switching voltage low, max.	2.5 V
Switching voltage, type.	23 V
Voltage type	DC

#### Switching output 1

Assignment	Connection 2, pin 5
Switching element	Transistor, PNP
Switching principle	+24 V switching
Function	"Muting state" signal output

### Time behavior

Response time	30 ms
Restart delay time	100 ms

### Interface

Type	AS-Interface Safety at Work
------	-----------------------------

#### AS-i

Function	Process
AS-i profile	Safe slave
Slave address	1..31 programmable, default=0
Cycle time acc. to AS-i specifications	Max. 5 ms

### Connection

Number of connections	2 Piece(s)
-----------------------	------------

#### Connection 1

Function	Machine interface
Type of connection	Connector
Thread size	M12
Material	Metal
No. of pins	5 -pin

#### Connection 2

Function	External muting indicator
Type of connection	Connector
Thread size	M12
Material	Metal
No. of pins	5 -pin

### Mechanical data

Design	Cubic
Dimension (W x H x L)	52 mm x 193 mm x 64.7 mm
Housing material	Metal
Metal housing	Aluminum
Lens cover material	Plastic / PMMA
Material of end caps	Diecast zinc
Net weight	600 g
Housing color	Yellow, RAL 1021
Type of fastening	Groove mounting
	Swivel mount

### Operation and display

Type of display	LED
Number of LEDs	2 Piece(s)

### Environmental data

Ambient temperature, operation	-30 ... 55 °C
Ambient temperature, storage	-40 ... 75 °C
Relative humidity (non-condensing)	0 ... 95 %

### Certifications

Degree of protection	IP 67
Protection class	III
Approvals	c CSA US
	TÜV Süd
US patents	US 6,418,546 B
	US 7,741,595 B

## Technical data

Customs tariff number	85365019
ECLASS 5.1.4	27272701
ECLASS 8.0	27272701
ECLASS 9.0	27272701
ECLASS 10.0	27272701
ECLASS 11.0	27272701
ECLASS 12.0	27272701
ECLASS 13.0	27272701
ECLASS 14.0	27272701
ECLASS 15.0	27272701
ECLASS 16.0	27272701
ETIM 5.0	EC001831
ETIM 6.0	EC001831
ETIM 7.0	EC001831
ETIM 8.0	EC001831
ETIM 9.0	EC001831
ETIM 10.0	EC001831
UNSPSC 26.08	32151804

## Dimensioned drawings

All dimensions in millimeters

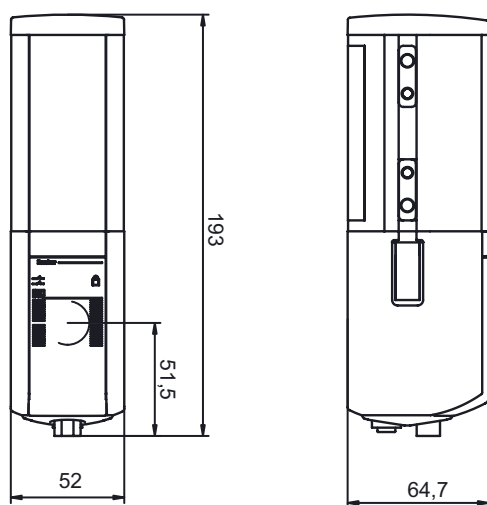

## Electrical connection

### Connection 1

Function	Machine interface
Type of connection	Connector
Thread size	M12
Type	Male
Material	Metal
No. of pins	5 -pin
Encoding	A-coded

## Electrical connection

Pin	Pin assignment	Conductor color
1	AS-i+	Brown
2	n.c.	White
3	AS-i-	Blue
4	n.c.	Black
5	n.c.	Gray



### Connection 2

Function	External muting indicator
Type of connection	Connector
Thread size	M12
Type	Female
Material	Metal
No. of pins	5 -pin
Encoding	A-coded

Pin	Pin assignment
1	AS-i+
2	0 V (auxiliary supply)
3	AS-i-
4	+24 V DC (auxiliary supply)
5	n.c.

## Operation and display

LED	Display	Meaning
1	Red, continuous light	OSSD off.
	Green, continuous light	OSSD on
	Red, flashing, 1 Hz	External error
	Red, flashing, 10 Hz	Internal error
	Green, flashing, 1 Hz	Weak signal, device not optimally aligned or soiled.
2	Yellow, continuous light	Start/restart interlock locked.
	Off	No voltage on AS-i cable.
	Red, continuous light	AS-i slave not communicating with AS-i master
	Yellow, flashing	AS-i slave has invalid address 0
	Red/green, flashing alternately	AS-i slave device error or AS-i connection defective
	Green, continuous light, flashing red at the same time	Periphery error
	Green, continuous light	AS-i slave communicating with AS-i master

## Suitable transmitters

	Part no.	Designation	Article	Description
	66502001	MLD500-T1L/A	Single light beam safety device transmitter	Special version: Integrated laser alignment aid Operating range: 0.5 ... 70 m Light source: LED, Infrared Type of interface: AS-Interface Safety at Work Connection: Connector, M12, Metal, 5 -pin

# Part number code

Part designation: **MLDxyy-zab/t**



<b>MLD</b>	<b>Multiple light beam safety device</b>
<b>x</b>	<b>Series</b> 3: MLD 300 5: MLD 500
<b>yy</b>	<b>Function classes</b> 00: transmitter 10: automatic restart 12: external testing 20: EDM/RES 30: muting 35: timing controlled 4-sensor muting
<b>z</b>	<b>Device type</b> T: transmitter R: receiver RT: transceiver xT: transmitter with high range xR: receiver for high range
<b>a</b>	Number of beams
<b>b</b>	<b>Option</b> L: integrated laser alignment aid (for transmitter/receiver) M: integrated status indicator (MLD 320, MLD 520) or integrated status and muting indicator (MLD 330, MLD 335, MLD 510/A, MLD 530, MLD 535) E: Connection socket for external muting indicator (AS-i models only)
<b>/t</b>	<b>Safety-related switching outputs (OSSDs), connection technology</b> -: transistor output, M12 plug A: Integrated AS-i interface, M12 plug, (safety bus system)

**Note**

 A list with all available device types can be found on the Leuze website at [www.leuze.com](http://www.leuze.com).

## Accessories

### Connection technology - Connection cables

	Part no.	Designation	Article	Description
	50133859	KD S-M12-5A-P1-020	Connection cable	Application: Oil and lubricant resistant Connection 1: Connector, M12, Axial, Female, A-coded, 5 -pin Connector, LED: No Connection 2: Open end Shielded: Yes Cable length: 2,000 mm Sheathing material: PUR
	50137014	KD S-M12-5A-P1-150	Connection cable	Application: Oil and lubricant resistant Connection 1: Connector, M12, Axial, Female, A-coded, 5 -pin Connector, LED: No Connection 2: Open end Shielded: Yes Cable length: 15,000 mm Sheathing material: PUR
	50136146	KD S-M12-5A-P1-250	Connection cable	Application: Oil and lubricant resistant Connection 1: Connector, M12, Axial, Female, A-coded, 5 -pin Connector, LED: No Connection 2: Open end Shielded: Yes Cable length: 25,000 mm Sheathing material: PUR

## Accessories

### Muting - Mounting systems

	Part no.	Designation	Article	Description
	424421	BT-SB10	Mounting bracket set	Design of mounting device: Mounting clamp Fastening, at system: Through-hole mounting Mounting bracket, at device: Clampable Type of mounting device: Swiveling Swivel range: -8 ... 8 ° Material: Metal

### Services

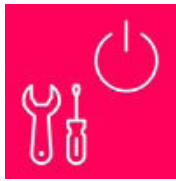
	Part no.	Designation	Article	Description
	S981050	CS40-I-140	Safety inspection	Details: Checking of a safety light barrier application in accordance with current standards and guidelines. Inclusion of the device and machine data in a database, production of a test log per application. Conditions: It must be possible to stop the machine, support provided by customer's employees and access to the machine for Leuze employees must be ensured.
	S981046	CS40-S-140	Start-up support	Details: For safety devices including stopping time measurement and initial inspection. Conditions: Devices and connection cables are already mounted, price not including travel costs and, if applicable, accommodation expenses.

#### Note



↪ A list with all available accessories can be found on the Leuze website in the Download tab of the article detailed page.