

Technical data sheet Light curtain receiver

Part no.: 50131316

CSL505-R05-355-M8

Contents

- Technical data
- Dimensioned drawings
- Electrical connection
- Operation and display
- Suitable transmitters
- Part number code
- Accessories



For illustration purposes only



Technical data

Basic data

Series	505
Operating principle	Throughbeam principle
Device type	Receiver
Application	Precise object detection

Special version

Special version	Crossed-beam scanning
	Diagonal-beam scanning
	Parallel-beam scanning
	Teach input
	Warning output

Optical data

Measurement field length	355 mm
Number of beams	72 Piece(s)
Beam spacing	5 mm

Measurement data

Minimum object diameter	7.5 mm
-------------------------	--------

Electrical data

Protective circuit	Inductive protection
	Polarity reversal protection
	Short circuit protected

Performance data

Supply voltage U_B	18 ... 30 V, DC
----------------------	-----------------

Outputs

Number of digital switching outputs	2 Piece(s)
-------------------------------------	------------

Switching outputs

Type	Digital switching output
Voltage type	DC
Switching current, max.	150 mA

Switching output 1

Switching element	Transistor, Push-pull
Switching principle	Light/dark switchable

Switching output 2

Switching element	Transistor, Push-pull
Switching principle	Light/dark switchable

Time behavior

Cycle time	76 ms
Response time per beam	1,000 μ s

Connection

Number of connections	1 Piece(s)
-----------------------	------------

Connection 1

Function	Signal OUT
	Teach input
	Voltage supply
Type of connection	Connector
Thread size	M8
Type	Male
Material	Metal
No. of pins	4 -pin
Encoding	A-coded

Mechanical data

Design	Cubic
Dimension (W x H x L)	12 mm x 58 mm x 440 mm
Housing material	Metal
Metal housing	Aluminum
Lens cover material	Plastic
Net weight	493 g
Housing color	Silver
Type of fastening	Through-hole mounting

Operation and display

Type of display	LED
Number of LEDs	2 Piece(s)
Type of configuration	Software
	Via pin assignment

Environmental data

Ambient temperature, operation	-30 ... 50 °C
Ambient temperature, storage	-40 ... 65 °C

Certifications

Degree of protection	IP 65
Protection class	III
Standards applied	EN 60947-5-2 (German version)

Classification

Customs tariff number	90314990
ECLASS 5.1.4	27270910
ECLASS 8.0	27270910
ECLASS 9.0	27270910
ECLASS 10.0	27270910
ECLASS 11.0	27270910
ECLASS 12.0	27270910
ECLASS 13.0	27270910
ECLASS 14.0	27270910
ECLASS 15.0	27270910
ECLASS 16.0	27270910
ETIM 5.0	EC002549
ETIM 6.0	EC002549
ETIM 7.0	EC002549
ETIM 8.0	EC002549
ETIM 9.0	EC002549
ETIM 10.0	EC002549
UNSPSC 26.08	39121528

Dimensioned drawings

All dimensions in millimeters

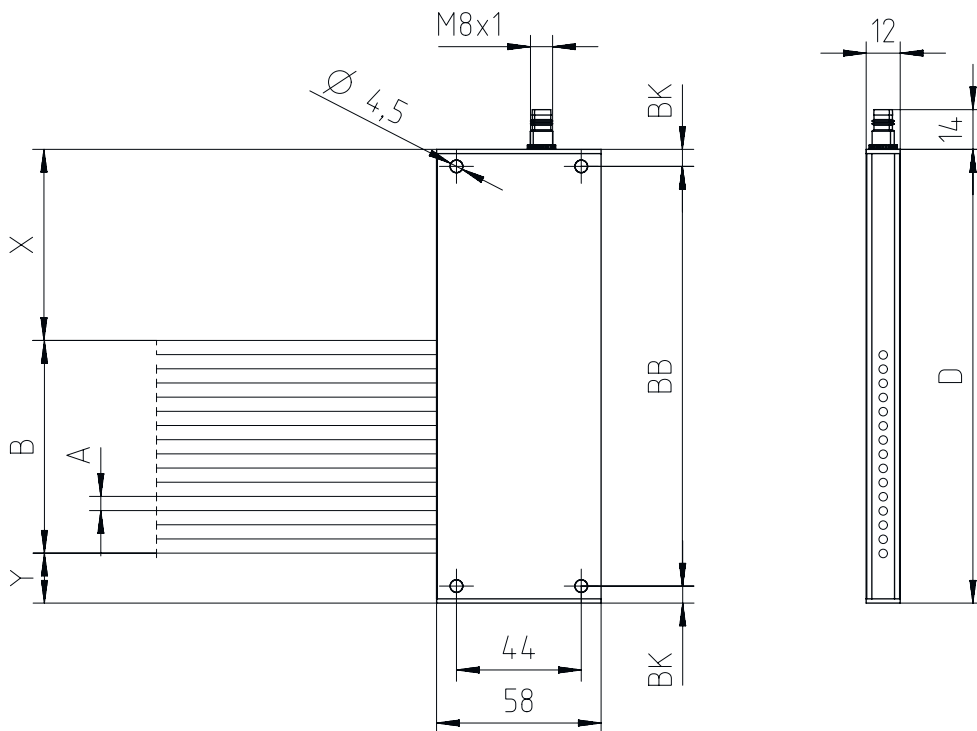

Electrical connection

Connection 1

Function	Signal OUT Teach input Voltage supply
Type of connection	Connector
Thread size	M8
Type	Male
Material	Metal
No. of pins	4 -pin
Encoding	A-coded

Pin	Pin assignment
1	V+
2	OUT 1 / Teach-in / Warning output
3	GND
4	OUT 2



Operation and display

Display LED 1	Display LED 2	Meaning
Off	Off	Off
Red, continuous light	Red, continuous light	Operational readiness
Red, continuous light	Off	Object detected
Red, flashing	Red, continuous light	Ready with minor error
Red, flashing	Off	Object detected with minor error
Red, double flash	Off	Configuration error
Red, flashing in phase	Red, flashing in phase	Serious error A
Red, flashing out of phase	Red, flashing out of phase	Serious error B
Red, continuous light	Red, double flash	Teach event successful

Suitable transmitters

Part no.	Designation	Operating range Operating range limit	Description
50131373	CSL505-T05-355-M8	0.3 ... 5 m	Application: Precise object detection Special version: Diagonal-beam scanning, Crossed-beam scanning, Parallel-beam scanning Operating range: 0.3 ... 5 m Connection: Connector, M8, 4 -pin

Part number code

Part designation: **CSL505-XXXX-ZZZZ-AA-BBB**

X	Operating principle T: transmitter R: receiver
YYY	Beam spacing 05: 5 mm 12.5: 12.5 mm 25: 25 mm 50: 50 mm 100: 100 mm
ZZZZ	Measurement field length Measurement field length [mm], dependent on beam spacing
AA	Electrical connection M8: M8 connector, 4-pin (plug)

Note



A list with all available device types can be found on the Leuze website at www.leuze.com.

Accessories

Connection technology - Connection cables

	Part no.	Designation	Article	Description
	50130850	KD U-M8-4A-V1-050	Connection cable	Application: Chemical resistant Connection 1: Connector, M8, Axial, Female, 4 -pin Connector, LED: No Connection 2: Open end Shielded: No Cable length: 5,000 mm Sheathing material: PVC
	50130871	KD U-M8-4W-V1-050	Connection cable	Application: Chemical resistant Connection 1: Connector, M8, Angled, Female, 4 -pin Connector, LED: No Connection 2: Open end Shielded: No Cable length: 5,000 mm Sheathing material: PVC

Configuration devices

	Part no.	Designation	Article	Description
	50132069	CSL505-Interface	Module	Functions: Configuration and test device Connection: Sub-D

Note



A list with all available accessories can be found on the Leuze website in the Download tab of the article detailed page.