

PRK 46B Ex n

Retro-reflective photoelectric sensor with polarization filter

2026/02/04 50109200-05



0.05 ... 18m

- Polarized retro-reflective photoelectric sensor
- Fast alignment through *brightVision*[®]
- A²LS - Active Ambient Light Suppression
- Push-pull outputs
- Relay output - for operation without reference potential
- Operating range adjustment
- Warning output for increased availability
- ATEX certification:
 - Ex II 3G Ex ec IIB T4 Gc X
 - Ex II 3D Ex tc IIIC T70°C Dc X
- IECEx BVS 21.0077X
 - Ex ec IIB T4 Gc
 - Ex tc IIIC T70°C Dc
- UL approval  is available for the sensor used without an enclosure

Accessories:

(available separately)

- Mounting systems (BT 46, BT 46.1, BT 46.1.5, BT 46.2)
- M12 connectors (KD ...)
- Ready-made cables (KD ...)
- Reflectors
- Reflective tapes
- Interlocking guard K-VM12-Ex (Part no. 501 09217)

Dimensioned drawing

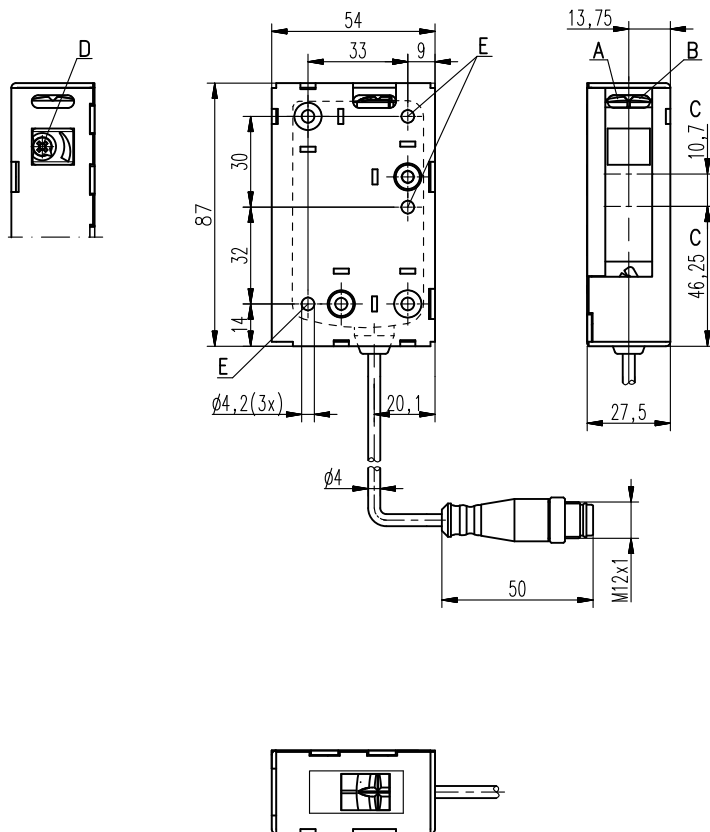

- A Green indicator diode
- B Yellow indicator diode
- C Optical axis
- D Optional operating range adjustment
- E Fastening hole

Electrical connection

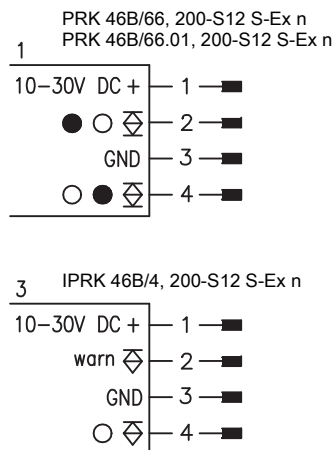

We reserve the right to make changes

Technical data

Optical data

Typ. op. range limit (TK(S) 100x100) ¹⁾ 0.05 ... 18m
 Operating range ²⁾ See tables
 Light source ³⁾ LED (modulated light)
 Wavelength 620nm (visible red light, polarized)

Time behavior

Switching frequency Transistor: 500Hz
 Response time Transistor: 1ms
 Readiness delay ≤ 300ms

Electrical data

With transistor switching outputs

Operating voltage U_B 10 ... 30VDC (incl. residual ripple)
 Residual ripple ≤ 15% of U_B
 Open-circuit current ≤ 20mA
 Switching output .../66. ... 2 push-pull switching outputs ⁴⁾
 Pin 2: PNP dark switching, NPN light switching
 Pin 4: PNP light switching, NPN dark switching
 PNP switching output, pin 4: light switching
 $\geq (U_B - 2V) \leq 2V$
 Max. 50mA
 Adjustable, 270° (PRK 46B/66.01... only)

Signal voltage high/low .../4. ...
 Output current
 Operating range

Indicators

Green LED Ready
 Yellow LED Light path free
 Yellow LED, flashing Light path free, no function reserve

Mechanical data

Housing Plastic (PC-ABS)
 Optics cover Plastic (PMMA)
 Weight (with connector/with cable and conn.) 50g/65g
 Connection type Cable with M12 connector, cable length: 200mm

Environmental data

Ambient temp. (operation/storage) -20°C ... +50°C/-30°C ... +70°C
 Protective circuit ⁵⁾ 2, 3
 VDE protection class ⁶⁾ II, all-insulated
 Degree of protection IP 67, IP 69K
 Light source Exempt group (in acc. with EN 62471)
 Standards applied IEC 60947-5-2

Explosion protection

Certification ATEX: Ex II 3G Ex ec IIB T4 Gc X
 Ex II 3D Ex tc IIIC T70°C Dc X
 Certification IECEx: Ex ec IIB T4 Gc
 Ex tc IIIC T70°C Dc

Additional functions

Warning output autoControl PNP transistor, counting principle
 Signal voltage high/low $\geq (U_B - 2V) \leq 2V$
 Output current Max. 50mA

- 1) Typ. operating range limit: max. attainable range without function reserve
- 2) Operating range: recommended range with function reserve
- 3) Average life expectancy 100,000 h at an ambient temperature of 25°C
- 4) The push-pull switching outputs must not be connected in parallel
- 5) 2=polarity reversal protection, 3=short circuit protection for all transistor outputs
- 6) Rating voltage 50VAC

Order guide

Cable with M12 connector, length: 200 mm	Designation	Part no.
Complementary switching output + operating range adjustment		
Housing model S (standard)	PRK 46B/66.01, 200-S12 S-Ex n	501 08593
Antivalent switching output		
Housing model S (standard)	PRK 46B/66, 200-S12 S-Ex n	501 08591
PNP switching output light switching, warning output		
Housing model S (standard)	IPRK 46B/4, 200-S12 S-Ex n	501 08945

Tables

Reflectors	Operating range
1 TK(S) 100x100	0.05 ... 15m
2 TK 82.2	0.25 ... 11m
3 TK(S) 50x50	0.05 ... 10m
4 TK(S) 40x60	0.05 ... 8m
5 TK(S) 20x40	0.05 ... 3m
6 Film 4 50x50	0.2 ... 2m

1	0.05	15	18
2	0.25	11	14
3	0.05	10	1
4	0.05	8	1
5	0.05	3	5
6	0.2	2	3

Operating range [m]
 Typ. operating range limit [m]

TK ... = adhesive
 TKS ... = screw type
 Film 4 = adhesive

Diagrams

Typ. response behavior (TK 100x100)

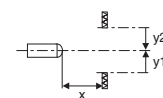
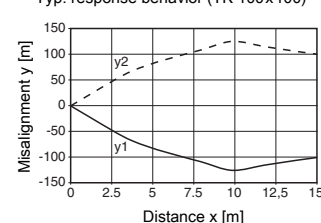

Typ. function reserve

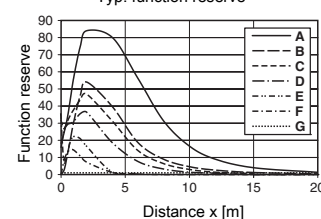

- A TK 100x100
- B TK 82.2
- C TK 50x50
- D TKS 40x60
- E TKS 20x40
- F Film 4 50x50
- G Switching point

Notes

Observe intended use!

- ⚠ This product is not a safety sensor and is not intended as personnel protection.
- ⚠ The product may only be put into operation by competent persons.
- ⚠ Only use the product in accordance with its intended use.

Ex devices

Notices for the safe use of sensors in potentially explosive areas

This document is valid for devices with the following classifications:

Device group	Device category	Equipment protection level	Zone
II	3G	Gc	Zone 2
II	3D	Dc	Zone 22

⚠ ATTENTION!	
	<ul style="list-style-type: none"> ● Check whether the equipment classification corresponds to the requirements of the application. ● The devices are not suited for the protection of persons and may not be used for emergency shutdown purposes. ● A safe operation is only possible if the equipment is used properly and for its intended purpose. ● Electrical equipment may endanger humans and (where applicable) animal health, and may threaten the safety of goods if used incorrectly or under unfavorable conditions in potentially explosive areas. ● The applicable national regulations (e.g. EN 60079-14) for the configuration and installation of explosion-proof systems must be observed without fail.

Installation and Commissioning (see also Special conditions)

- The devices must only be installed and commissioned by trained electricians. They must be aware of the regulations and operation of explosion-proof equipment.
- The connector of series 46B sensors must be equipped with a safeguard or a mechanical interlocking guard (e.g. K-VM 12-Ex, part no. 50109217) to prevent unintentional separation under voltage. An additional warning sign "WARNING – DO NOT SEPARATE WHEN ENERGIZED" that is supplied with the device must be attached to the sensor or its mounting bracket so that it is clearly visible. This notice must be attached to the device before it is taken into operation.
- Connection cables and connectors must be protected from excessive or unintended pulling or pushing strain.
- Prevent dust deposits from forming on the devices.

Maintenance

- No changes may be made to explosion-proof devices.
- Repairs may only be performed by a person trained for such work or by the manufacturer.
- Defective devices must be replaced immediately.
- Cyclical maintenance is generally not necessary.
- Depending on the environmental conditions, it may occasionally be necessary to clean the optical surfaces of the sensors. This cleaning must only be performed by persons trained for performing this task. We recommend the use of a soft and damp cloth. Cleaning agents containing solvents must not be used.

Chemical resistance

- The sensors demonstrate good resistance against diluted (weak) acids and bases.
- Exposure to organic solvents is possible only under certain circumstances and only for short periods of time.
- Resistance to chemicals must be examined on a case by case basis.

Special conditions

- The devices must be installed in such a way that they are protected from direct exposure to UV rays (sunlight).
- The metallic cage has to be integrated into the potential equalization before usage to prevent electrostatic charge.
- The light barriers must not be installed in areas where processes with high static charges occur.
- The light barriers may only be used if high or repeated electrostatic processes are surely excluded by installation.
- The metallic cage is screwed together with two torx-screws.
- The connector of series 46B sensors must be equipped with a safeguard or a mechanical interlocking guard to prevent unintentional separation under voltage.
- The connector provided by the user in the final application shall be in accordance with all applicable clauses of IEC 60079-0, IEC 60079-7 and IEC 60079-31. A minimum of IP54 according to IEC 60529 shall be ensured.