

Technical data sheet

Ultrasonic sensor

Part no.: 50150570

HTU420B-500.3/GT-M8



For illustration purposes only

Contents

- Technical data
- Dimensioned drawings
- Electrical connection
- Diagrams
- Operation and display
- Part number code
- Notes
- Accessories



Technical data

Basic data

Series	420B
Operating principle	Diffuse reflection principle with background suppression

Special version

Special version	Teach input
-----------------	-------------

Characteristic parameters

MTTF	430 years
------	-----------

Ultrasonic specifications

Operating range	0.015 ... 0.5 m
Operating range	Guaranteed operating range
Ultrasonic frequency	290 kHz
Shape of sound lobe	standard
Direction of beam	Front
Opening angle	7 °
Adjustment range	15 ... 500 mm

Measurement data

Resolution	1.0 mm
Repeatability	0.5 mm
Temperature drift	2 %
Reference value, temperature drift	End value

Electrical data

Protective circuit	Inductive protection
	Polarity reversal protection
	Short circuit protected

Performance data

Supply voltage U_B	12 ... 30 V, DC
Residual ripple	0 ... 10 %, From U_B
Open-circuit current	0 ... 35 mA
Switching hysteresis	4 %

Inputs

Number of teach inputs	1 Piece(s)
------------------------	------------

Teach inputs

Voltage type	DC
Switching voltage	high: $\geq 12V$
	low: $\leq 2 V$

Teach input 1

Active switching state	High
------------------------	------

Outputs

Number of digital switching outputs	1 Piece(s)
-------------------------------------	------------

Switching outputs

Voltage type	DC
Switching current, max.	100 mA
Switching voltage	low: $\leq 2 V$

Switching output 1

Switching element	Transistor, Push-pull
Switching principle	Dark switching (PNP)/light switching (NPN)

Time behavior

Switching frequency	12 Hz
Response time	40 ms
Readiness delay	300 ms

Connection

Number of connections	1 Piece(s)
-----------------------	------------

Connection 1

Function	Signal OUT
	Teach input
	Voltage supply
Type of connection	Connector
Thread size	M8
Type	Male
Material	Metal
No. of pins	4 -pin

Mechanical data

Design	Cubic
Dimension (W x H x L)	20.5 mm x 41 mm x 15 mm
Housing material	Plastic
Plastic housing	ASA, PMMA
Ultrasonic transducer material	Piezoceramics (contains lead zirconium titanate (PZT))
Net weight	22 g
Housing color	Black
Type of fastening	Through-hole mounting

Operation and display

Type of display	LED
Number of LEDs	3 Piece(s)
Operational controls	Teach button
Function of the operational control	Range adjustment

Environmental data

Ambient temperature, operation	-25 ... 65 °C
Ambient temperature, storage	-25 ... 75 °C

Certifications

Degree of protection	IP 67
Protection class	III
Approvals	c UL US
Standards applied	IEC 60947-5-2

Technical data

Customs tariff number	85365019
ECLASS 5.1.4	27272803
ECLASS 8.0	27272803
ECLASS 9.0	27272803
ECLASS 10.0	27272803
ECLASS 11.0	27272803
ECLASS 12.0	27272803
ECLASS 13.0	27272803
ECLASS 14.0	27272803
ECLASS 15.0	27272803
ECLASS 16.0	27272803
ETIM 5.0	EC001849
ETIM 6.0	EC001849
ETIM 7.0	EC001849
ETIM 8.0	EC001849
ETIM 9.0	EC001849
ETIM 10.0	EC001849
UNSPSC 26.08	41111960

Dimensioned drawings

All dimensions in millimeters

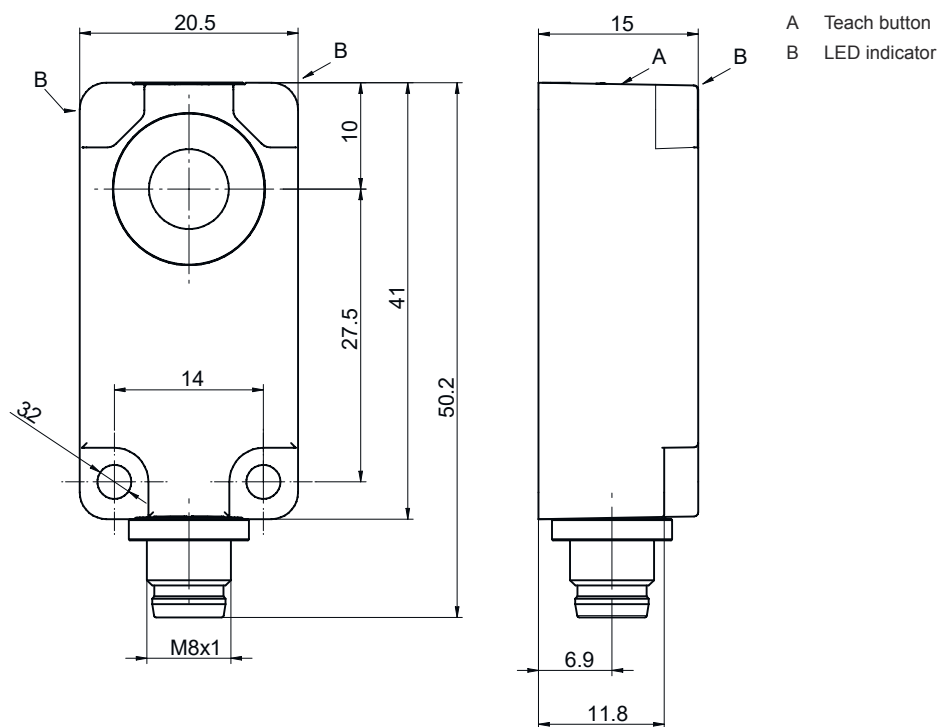

Electrical connection

Connection 1

Function	Signal OUT
	Teach input
	Voltage supply
Type of connection	Connector
Thread size	M8
Type	Male
Material	Metal
No. of pins	4 -pin

Pin	Pin assignment
1	V+
2	Teach-in
3	GND
4	OUT 1



Diagrams

Typ. response behavior

Standard object, size 30 x 30 mm, aligned perpendicular to the sensor reference axis

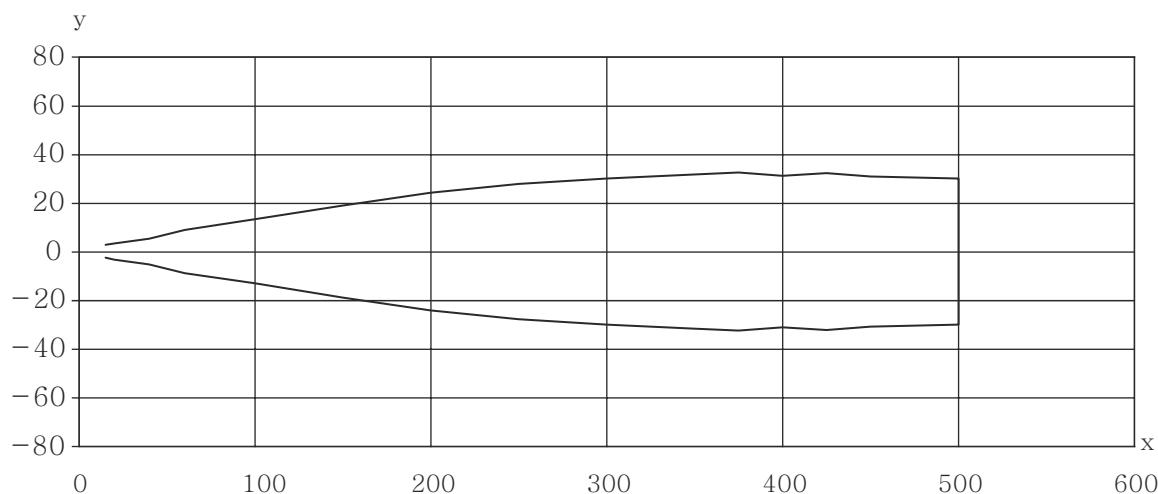

x Object distance [mm]
y Sound cone width [mm]

Operation and display

LED	Display	Meaning
1	Blue, continuous light	Teach active
2	Green, continuous light	Operational readiness
3	Yellow, continuous light	Object detected

Part number code

Part designation: **AAA4BB-xxxx.C/DEF-GG**

AAA	Operating principle HTU: Ultrasonic sensor, scanning principle, with background suppression DMU: Ultrasonic sensor, distance measurement
4BB	Design 420B: Cubic 412B: Cylindrical with M12 thread
xxxx	Operating range Operating range in millimeters
C	Operating range adjustment 3: teach-in via button
D	Switching output / function OUT 1/IN: Pin 4 6: push-pull switching output, PNP light switching, NPN dark switching G: Push-pull switching output, PNP dark switching, NPN light switching L: IO-Link / light switching (PNP)/dark switching (NPN)
E	Switching output / function OUT 2/IN: pin 2 T: teach-in via cable C: Analog current output V: Analog voltage output X: pin not used 6: push-pull switching output, PNP light switching, NPN dark switching
F	Switching output / function OUT 3/IN: Pin 5 T: teach-in via cable
GG	Electrical connection M12: M12 connector M8: M8 connector

Note



A list with all available device types can be found on the Leuze website at www.leuze.com.

Notes

 **Observe intended use!**



- ⌘ This product is not a safety sensor and is not intended as personnel protection.
- ⌘ The product may only be put into operation by competent persons.
- ⌘ Only use the product in accordance with its intended use.

 **For UL applications:**



- ⌘ For UL applications, use is only permitted in Class 2 circuits in accordance with the NEC (National Electric Code).

Accessories

Connection technology - Connection cables

	Part no.	Designation	Article	Description
	50130850	KD U-M8-4A-V1-050	Connection cable	Application: Chemical resistant Connection 1: Connector, M8, Axial, Female, 4 -pin Connector, LED: No Connection 2: Open end Shielded: No Cable length: 5,000 mm Sheathing material: PVC
	50130871	KD U-M8-4W-V1-050	Connection cable	Application: Chemical resistant Connection 1: Connector, M8, Angled, Female, 4 -pin Connector, LED: No Connection 2: Open end Shielded: No Cable length: 5,000 mm Sheathing material: PVC

Note



A list with all available accessories can be found on the Leuze website in the Download tab of the article detailed page.