

Technical data sheet

Tower light element

Part no.: 50143950

A7-MP1-100-M12

Contents

- Technical data
- Dimensioned drawings
- Electrical connection
- Notes
- Accessories



For illustration purposes only



Technical data

Basic data

Series	A7
--------	----

Connection

Connection 1

Type of connection	Connector
--------------------	-----------

Mechanical data

Design	Cylindrical
Dimension (Ø x L)	70 mm x 146 mm
Housing material	Plastic
Net weight	138 g
Housing color	Black
Design of mounting device	Horizontal mounting
Type of fastening, at system	Screw type / horizontal
Module holder	One side
Number of end caps	1 Piece(s)

Environmental data

Ambient temperature, operation	-10 ... 60 °C
--------------------------------	---------------

Certifications

Degree of protection	IP 66
Approvals	CE
	CSA

Classification

Customs tariff number	85318070
ECLASS 5.1.4	27371234
ECLASS 8.0	27371234
ECLASS 9.0	27371234
ECLASS 10.0	27371234
ECLASS 11.0	27371234
ECLASS 12.0	27371234
ECLASS 13.0	27371234
ECLASS 14.0	27371234
ECLASS 15.0	27371234
ECLASS 16.0	27371234
ETIM 5.0	EC001259
ETIM 6.0	EC001259
ETIM 7.0	EC001259
ETIM 8.0	EC001259
ETIM 9.0	EC001259
ETIM 10.0	EC001259
UNSPSC 26.08	32151500

Dimensioned drawings

All dimensions in millimeters

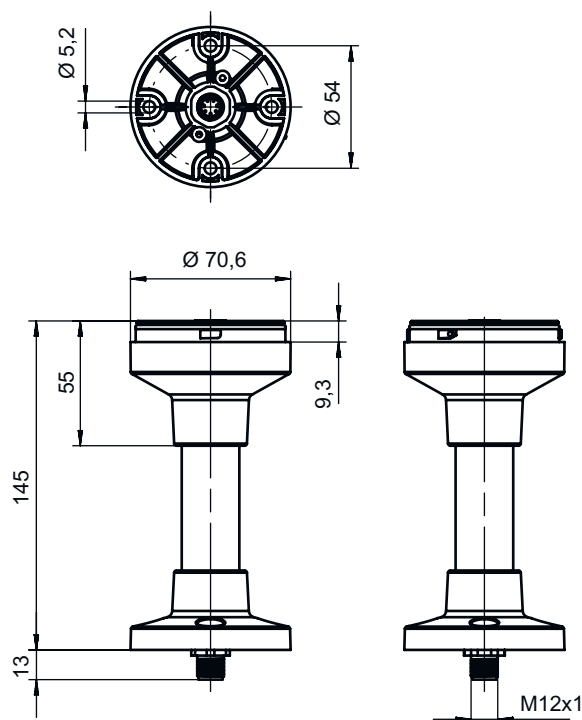

Electrical connection

Connection 1

Function	Voltage supply
Type of connection	Connector
Thread size	M12
Type	Male
Material	Metal
No. of pins	8 -pin
Encoding	A-coded

Pin	Pin assignment	Conductor color
1	Light color: white	White
2	n.c.	Brown
3	Light color: green	Green
4	Light color: yellow/orange	Yellow
5	GND	Gray
6	n.c.	Pink
7	VCC / Light color: blue	Blue
8	VCC / Light color: red	Red

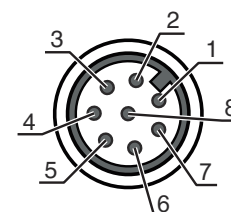

Notes





Observe intended use!



- ⚠ This product is not a safety sensor and is not intended as personnel protection.
- ⚠ The product may only be put into operation by competent persons.
- ⚠ Only use the product in accordance with its intended use.



Accessories

Connection technology - Connection cables



	Part no.	Designation	Article	Description
	50135127	KD S-M12-8A-P1-020	Connection cable	Application: Oil and lubricant resistant Connection 1: Connector, M12, Axial, Female, A-coded, 8 -pin Connector, LED: No Connection 2: Open end Shielded: Yes Cable length: 2,000 mm Sheathing material: PUR
	50135128	KD S-M12-8A-P1-050	Connection cable	Application: Oil and lubricant resistant Connection 1: Connector, M12, Axial, Female, A-coded, 8 -pin Connector, LED: No Connection 2: Open end Shielded: Yes Cable length: 5,000 mm Sheathing material: PUR
	50135133	KD S-M12-8W-P1-050	Connection cable	Application: Oil and lubricant resistant Connection 1: Connector, M12, Angled, Female, A-coded, 8 -pin Connector, LED: No Connection 2: Open end Shielded: Yes Cable length: 5,000 mm Sheathing material: PUR

Accessories

Muting - Mounting systems

	Part no.	Designation	Article	Description
	50142896	A7-MW2	Tower light element	Design: L shape Version: Angle, L-shape Fastening, at system: Through-hole mounting
	50143660	A7-MW2.5	Tower light element	Design: L shape Version: Angle, L-shape Fastening, at system: Through-hole mounting

General

	Part no.	Designation	Article	Description
	50135462	A7-V1-BZ1-M	Tower light element	Signaling: Acoustic Current consumption, max.: 70 mA Design: Cylindrical Fastening: Bayonet system Operational controls: DIP switch, 225° potentiometer Ambient temperature: -10 ... 60 °C Degree of protection: IP 66 Tone type: Continuous or pulse tone Sound pressure: 100 dB Number of tones: 8 Piece(s)
	50138151	A7-V1-BZ2-S	Tower light element	Signaling: Acoustic Current consumption, max.: 30 mA Design: Cylindrical Fastening: Bayonet system Operational controls: 225° potentiometer Ambient temperature: -10 ... 60 °C Degree of protection: IP 66 Tone type: Continuous tone Sound pressure: 105 dB Number of tones: 1 Piece(s)
	50135457	A7-V1-DS-R-T	Tower light element	Signaling: Optical Current consumption, max.: 50 mA Design: Cylindrical Fastening: Bayonet system Illuminant: LED/24V Signal image: Continuous light Lens color: Red Angle of radiation: 360° Ambient temperature: -10 ... 60 °C Degree of protection: IP 66

Note



A list with all available accessories can be found on the Leuze website in the Download tab of the article detailed page.