

Technical data sheet

Optical distance sensor

Part no.: 50101882
ODSL 96K/66-2300-S12

Contents

- Technical data
- Dimensioned drawings
- Electrical connection
- Accessories



For illustration purposes only



CDRH

Technical data

Basic data

Series	96
Type of scanning system	Against object

Optical data

Light source	Laser, Red
Laser class	2, IEC/EN 60825-1:2014
Light spot size [at sensor distance]	3 mm x 8 mm [2,300 mm]
Type of light spot geometry	Rectangular

Measurement data

Measurement range	150 ... 2,300 mm
Resolution	1.0 ... 5.0 mm
Accuracy	3 %
Reference value, accuracy	Measurement distance
Repeatability	2 %
Reference value repeatability	Measurement distance
Measurement time	2 ... 7 ms
Referencing	No
Black/white behavior	1 %

Electrical data

Protective circuit	Polarity reversal protection
	Short circuit protected
	Transient protection

Performance data

Supply voltage U_B	10 ... 30 V, DC
Residual ripple	0 ... 15 %, From U_B
Open-circuit current	0 ... 150 mA

Inputs

Teach inputs

Voltage type	DC
Switching voltage	high: $\geq(U_B - 2V)$

Outputs

Number of digital switching outputs	2 Piece(s)
-------------------------------------	------------

Switching outputs

Type	Digital switching output
Switching voltage	high: $\geq(U_B - 2V)$

Switching output 1

Switching element	Transistor, Push-pull
-------------------	-----------------------

Switching output 2

Switching element	Transistor, Push-pull
-------------------	-----------------------

Time behavior

Connection

Number of connections	1 Piece(s)
-----------------------	------------

Connection 1

Function	Signal OUT
Type of connection	Connector
Thread size	M12
Type	Male
Material	Plastic
No. of pins	5 -pin

Mechanical data

Design	Cubic
Dimension (W x H x L)	30 mm x 90 mm x 70 mm
Housing material	Plastic
Plastic housing	PC
Lens cover material	Plastic
Net weight	140 g
Housing color	Red

Operation and display

Type of display	LED
Type of configuration	Switch
Operational controls	Teach button

Environmental data

Ambient temperature, operation	-20 ... 50 °C
Ambient temperature, storage	-30 ... 70 °C

Certifications

Degree of protection	IP 67
Protection class	II
Standards applied	IEC 60947-5-2

Classification

Customs tariff number	90318020
ECLASS 5.1.4	27270801
ECLASS 8.0	27270801
ECLASS 9.0	27270801
ECLASS 10.0	27270801
ECLASS 11.0	27270801
ECLASS 12.0	27270916
ECLASS 13.0	27270916
ECLASS 14.0	27270916
ECLASS 15.0	27270916
ECLASS 16.0	27270916
ETIM 5.0	EC001825
ETIM 6.0	EC001825
ETIM 7.0	EC001825
ETIM 8.0	EC001825
ETIM 9.0	EC001825
ETIM 10.0	EC001825
UNSPSC 26.08	39121528

Dimensioned drawings

All dimensions in millimeters

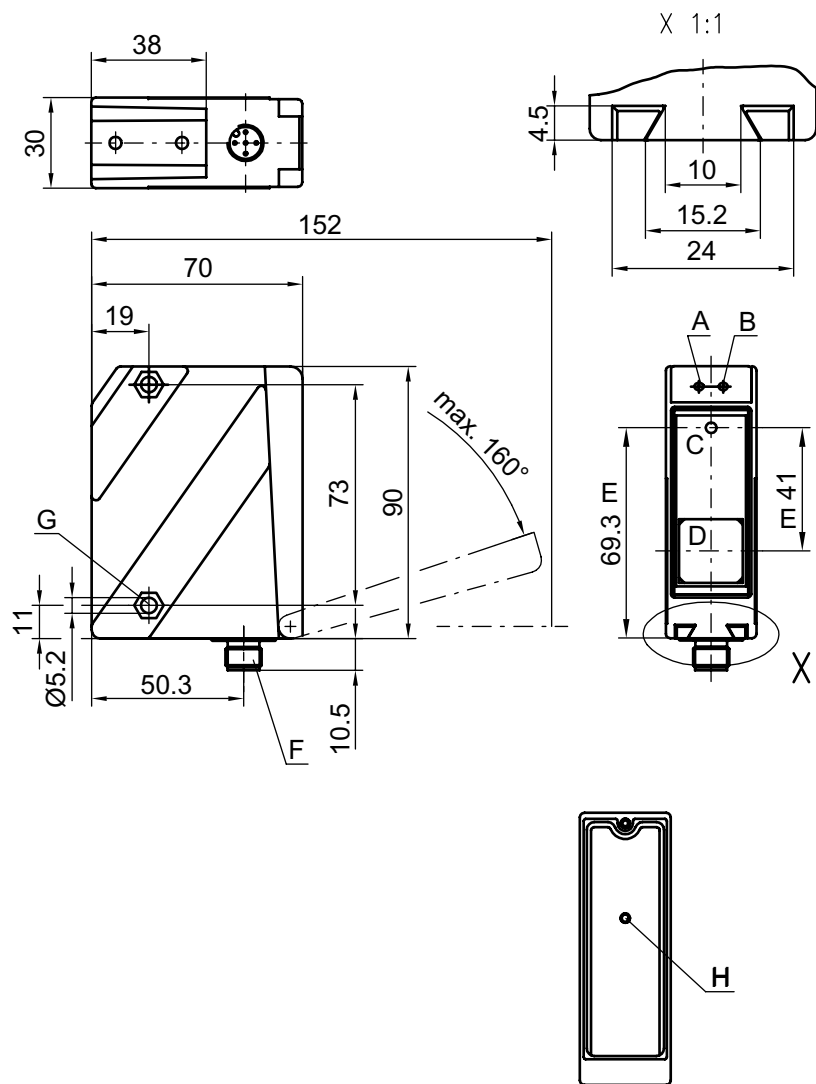

- Green indicator diode
- Yellow indicator diode
- Transmitter
- Receiver
- Optical axis
- Device plug M12
- Countersinking for SK nut M5, 4.2 mm deep
- Teach button













Electrical connection

Connection 1

Function	Signal OUT
Type of connection	Connector
Thread size	M12
Type	Male
Material	Plastic
No. of pins	5 -pin

Accessories

Connection technology - Connection cables

	Part no.	Designation	Article	Description
	50133855	KD S-M12-5A-V1-020	Connection cable	Application: Chemical resistant Connection 1: Connector, M12, Axial, Female, A-coded, 5 -pin Connector, LED: No Connection 2: Open end Shielded: Yes Cable length: 2,000 mm Sheathing material: PVC
				
				
	50133856	KD S-M12-5A-V1-050	Connection cable	Application: Chemical resistant Connection 1: Connector, M12, Axial, Female, A-coded, 5 -pin Connector, LED: No Connection 2: Open end Shielded: Yes Cable length: 5,000 mm Sheathing material: PVC
				
				
	50132077	KD U-M12-5A-V1-020	Connection cable	Application: Chemical resistant Connection 1: Connector, M12, Axial, Female, A-coded, 5 -pin Connector, LED: No Connection 2: Open end Shielded: No Cable length: 2,000 mm Sheathing material: PVC
				
				
	50133842	KD U-M12-5W-V1-020	Connection cable	Application: Chemical resistant Connection 1: Connector, M12, Angled, Female, A-coded, 5 -pin Connector, LED: No Connection 2: Open end Shielded: No Cable length: 2,000 mm Sheathing material: PVC
				
				

Mounting technology - Mounting brackets

	Part no.	Designation	Article	Description
	50025570	BT 96	Mounting device	Design of mounting device: Angle, L-shape Fastening, at system: Through-hole mounting Mounting bracket, at device: Screw type Type of mounting device: Rigid Material: Metal

Mounting technology - Rod mounts

	Part no.	Designation	Article	Description
	50082084	BT 450.1-96	Mounting device	Design of mounting device: Mounting system Fastening, at system: For 10 mm rod Mounting bracket, at device: Screw type Type of mounting device: Turning, 360°, Adjustable Material: Metal

Accessories

Note



🔗 A list with all available accessories can be found on the Leuze website in the Download tab of the article detailed page.