

Technical data sheet

Tower light

Part no.: 50156263

TL305-R-M12

Contents

- Technical data
- Dimensioned drawings
- Electrical connection
- Accessories



For illustration purposes only



Technical data

Basic data

Series	TL 305
Contains	1x M30 nut 1x rubber flat seal
Type of signaling	Optical

Electrical data

Performance data

Supply voltage U_B	24 V, DC
Current consumption, max.	55 mA

Inputs

Number of digital switching inputs	1 Piece(s)
------------------------------------	------------

Switching inputs

Type	Digital switching input
Switching voltage high, min.	24 V
Switching voltage low, max.	0 V
Voltage type	DC

Digital switching input 1

Assignment	Connection 1, pin 1
Function	Light color (red) through actuation of pin

Connection

Number of connections	1 Piece(s)
-----------------------	------------

Connection 1

Function	Light color via control of pins Signal IN Voltage supply
Type of connection	Connector
Thread size	M12
Type	Male
Material	Metal
No. of pins	5 -pin
Encoding	A-coded

Mechanical data

Design	Cylindrical
Dimension (\varnothing x L)	50.6 mm x 71 mm
Thread size	M30 x 1.5 mm
Housing material	Metal
Metal housing	Aluminium, anodized
Light area material	Plastic, Polycarbonate
Net weight	190 g
Housing color	Gray
Type of illuminant	LED/24V
Lens modules	1 piece, ready-made
Signal image	Continuous light
Angle of radiation	360°
Sequence of the modules (ascending)	Red

Environmental data

Ambient temperature, operation	0 ... 50 °C
Ambient temperature, storage	0 ... 50 °C

Certifications

Degree of protection	IP 65
Protection class	III
Approvals	UL

Classification

ECLASS 5.1.4	27371230
ECLASS 8.0	27371230
ECLASS 9.0	27371230
ECLASS 10.0	27371230
ECLASS 11.0	27371230
ECLASS 12.0	27371230
ECLASS 13.0	27371230
ECLASS 14.0	27371230
ECLASS 15.0	27371230
ECLASS 16.0	27371230
ETIM 5.0	EC001042
ETIM 6.0	EC001042
ETIM 7.0	EC001042
ETIM 8.0	EC001042
ETIM 9.0	EC001042
ETIM 10.0	EC001042
UNSPSC 26.08	39111714

Dimensioned drawings

All dimensions in millimeters

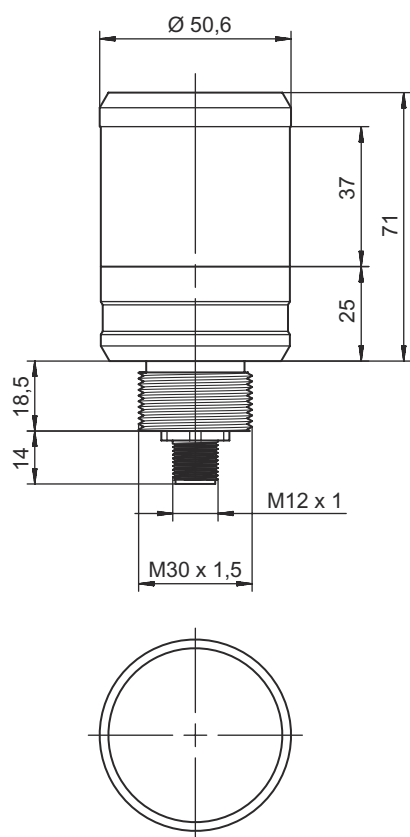

Electrical connection

Connection 1

Function	Light color via control of pins Signal IN Voltage supply
Type of connection	Connector
Thread size	M12
Type	Male
Material	Metal
No. of pins	5 -pin
Encoding	A-coded

Pin	Pin assignment	Conductor color
1	Red LED	Brown
2	n.c.	White
3	GND	Blue
4	n.c.	Black
5	n.c.	Gray

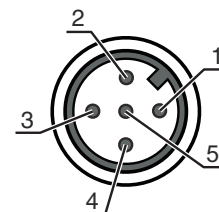

Accessories



Connection technology - Connection cables

	Part no.	Designation	Article	Description
	50132079	KD U-M12-5A-V1-050	Connection cable	Application: Chemical resistant Connection 1: Connector, M12, Axial, Female, A-coded, 5 -pin Connector, LED: No Connection 2: Open end Shielded: No Cable length: 5,000 mm Sheathing material: PVC

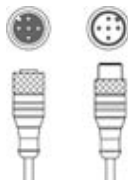
Connection technology - Interconnection cables

	Part no.	Designation	Article	Description
	50133298	KDS U-M12-5A-M12-5A-V1-050	Interconnection cable	Application: Chemical resistant Connection 1: Connector, M12, Axial, Female, A-coded, 5 -pin Connection 2: Connector, M12, Axial, Male, A-coded, 5 -pin Shielded: No Cable length: 5,000 mm Sheathing material: PVC

Mounting

	Part no.	Designation	Article	Description
	50149110	TL305-AC.EP.100	Tower light element	Design: Cylindrical Version: Extension pipe Fastening, at system: Screw type
	50149111	TL305-AC.MB1	Tower light element	Design: L shape Version: Angle, L-shape Fastening, at system: Screw type
	50149109	TL305-AC.MF.65	Tower light element	Design: Cylindrical Version: Mounting base Fastening, at system: Screw type

Note



A list with all available accessories can be found on the Leuze website in the Download tab of the article detailed page.