

## Technical data sheet

### Diffuse sensor with background suppression

Part no.: 50149612

HT3C.BVXL/4P-M8

#### Contents

- Technical data
- Dimensioned drawings
- Electrical connection
- Diagrams
- Operation and display
- Part number code
- Notes
- Further information
- Accessories



For illustration purposes only



## Technical data

### Basic data

|                     |   |
|---------------------|---|
| Series              | 3C  |
| Operating principle | Diffuse reflection principle with background suppression  |
| Application         | Detection of highly transparent bottles<br>Detection of objects with openings<br>Detection of transparent films |

### Special version

|                 |  |
|-----------------|--|
| Special version | Extra long light spot (XL)<br>V-optics |
|-----------------|--|

### Optical data

|                                      |                                      |
|--------------------------------------|--------------------------------------|
| Black-white error                    | < 20% up to 80 mm                    |
| Operating range                      | Guaranteed operating range           |
| Operating range, white 90%           | 0.01 ... 0.08 m                      |
| Operating range, gray 18%            | 0.012 ... 0.07 m                     |
| Operating range, black 6%            | 0.012 ... 0.06 m                     |
| Operating range limit, white 90%     | 0.01 ... 0.09 m                      |
| Operating range limit, gray 18%      | 0.012 ... 0.075 m                    |
| Operating range limit, black 6%      | 0.012 ... 0.065 m                    |
| Operating range limit                | Typical operating range              |
| Adjustment range                     | 20 ... 90 mm                         |
| Beam path                            | Divergent                            |
| Light source                         | LED, Red                             |
| Wavelength                           | 633 nm                               |
| Transmitted-signal shape             | Pulsed                               |
| LED group                            | Exempt group (in acc. with EN 62471) |
| Light spot size [at sensor distance] | 5 mm x 40 mm [70 mm]                 |
| Type of light spot geometry          | Rectangular                          |

### Electrical data

|                    |   |
|--------------------|---|
| Protective circuit | Polarity reversal protection<br>Short circuit protected |
|--------------------|---|

### Performance data

|                      |  |
|----------------------|--|
| Supply voltage $U_B$ | 10 ... 30 V, DC, Incl. residual ripple |
| Residual ripple      | 0 ... 15 %, From $U_B$                 |
| Open-circuit current | 0 ... 15 mA                            |

### Outputs

|                                     |            |
|-------------------------------------|------------|
| Number of digital switching outputs | 2 Piece(s) |
|-------------------------------------|------------|

### Switching outputs

|                         |   |
|-------------------------|---|
| Voltage type            | DC  |
| Switching current, max. | 100 mA                                    |
| Switching voltage       | high: $\geq(U_B - 2V)$<br>low: $\leq 2 V$ |

### Switching output 1

|                     |                     |
|---------------------|---------------------|
| Assignment          | Connection 1, pin 4 |
| Switching element   | Transistor, PNP     |
| Switching principle | Light switching     |

### Switching output 2

|                     |                     |
|---------------------|---------------------|
| Assignment          | Connection 1, pin 2 |
| Switching element   | Transistor, PNP     |
| Switching principle | Dark switching      |

### Time behavior

|                     |             |
|---------------------|-------------|
| Switching frequency | 1,000 Hz    |
| Response time       | 0.5 ms      |
| Readiness delay     | 300 ms      |
| Response jitter     | 166 $\mu$ s |

### Connection

#### Connection 1

|                    |                              |
|--------------------|------------------------------|
| Function           | Signal OUT<br>Voltage supply |
| Type of connection | Connector                    |
| Thread size        | M8                           |
| Type               | Male                         |
| Material           | Metal                        |
| No. of pins        | 4 -pin                       |

### Mechanical data

|                            |   |
|----------------------------|---|
| Dimension (W x H x L)      | 11.4 mm x 34.2 mm x 18.3 mm                             |
| Housing material           | Plastic   |
| Plastic housing            | PC-ABS  |
| Lens cover material        | Plastic / PMMA  |
| Net weight                 | 10 g  |
| Housing color              | Red   |
| Type of fastening          | Two M3 threaded sleeves<br>Via optional mounting device |
| Compatibility of materials | ECOLAB  |

### Operation and display

|                                     |                         |
|-------------------------------------|-------------------------|
| Type of display                     | LED                     |
| Number of LEDs                      | 2 Piece(s)              |
| Operational controls                | Multiturn potentiometer |
| Function of the operational control | Range adjustment        |

### Environmental data

|                                |               |
|--------------------------------|---------------|
| Ambient temperature, operation | -40 ... 60 °C |
| Ambient temperature, storage   | -40 ... 70 °C |

### Certifications

|                      |                 |
|----------------------|-----------------|
| Degree of protection | IP 67<br>IP 69K |
| Protection class     | III             |
| Approvals            | c UL US         |
| Standards applied    | IEC 60947-5-2   |

## Technical data

|                       |          |
|-----------------------|----------|
| Customs tariff number | 85365019 |
| ECLASS 5.1.4          | 27270904 |
| ECLASS 8.0            | 27270904 |
| ECLASS 9.0            | 27270904 |
| ECLASS 10.0           | 27270904 |
| ECLASS 11.0           | 27270904 |
| ECLASS 12.0           | 27270903 |
| ECLASS 13.0           | 27270903 |
| ECLASS 14.0           | 27270903 |
| ECLASS 15.0           | 27270903 |
| ETIM 5.0              | EC002719 |
| ETIM 6.0              | EC002719 |
| ETIM 7.0              | EC002719 |
| ETIM 8.0              | EC002719 |
| ETIM 9.0              | EC002719 |
| ETIM 10.0             | EC002719 |

## Dimensioned drawings

All dimensions in millimeters

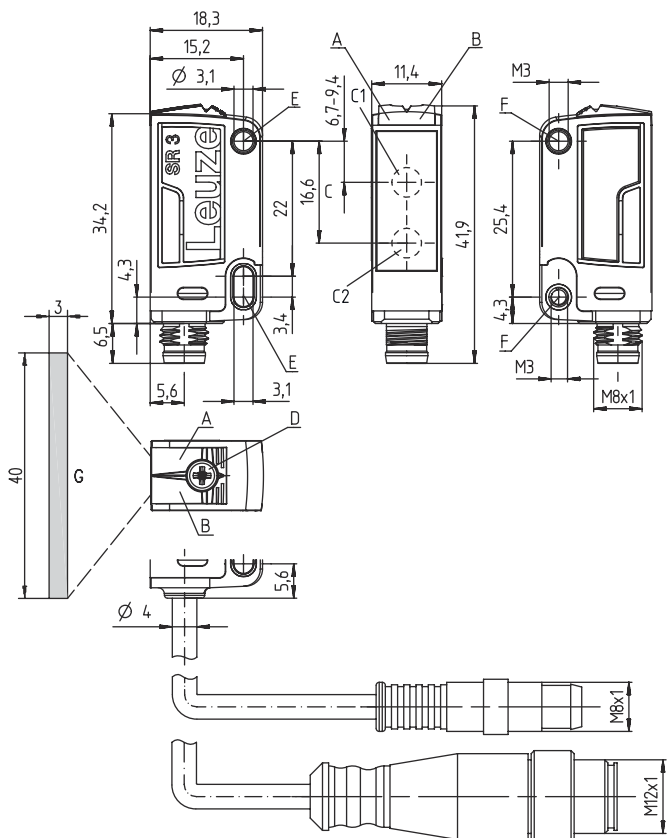

- A Green LED
- B Yellow LED
- C Optical axis
- C1 Receiver
- C2 Transmitter
- D Multiturn potentiometer
- E Mounting sleeve (standard)
- F Threaded sleeve (3C.B series)
- G Light spot 3 mm x 40 mm at a range of 50 mm

## Electrical connection

### Connection 1

|                    |                |
|--------------------|----------------|
| Function           | Signal OUT     |
|                    | Voltage supply |
| Type of connection | Connector      |
| Thread size        | M8             |
| Type               | Male           |
| Material           | Metal          |
| No. of pins        | 4 -pin         |

| Pin | Pin assignment |
|-----|----------------|
| 1   | V+             |
| 2   | OUT 2          |
| 3   | GND            |
| 4   | OUT 1          |

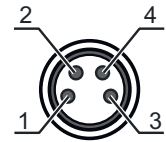

## Diagrams

Typ. response behavior (white 90 %)

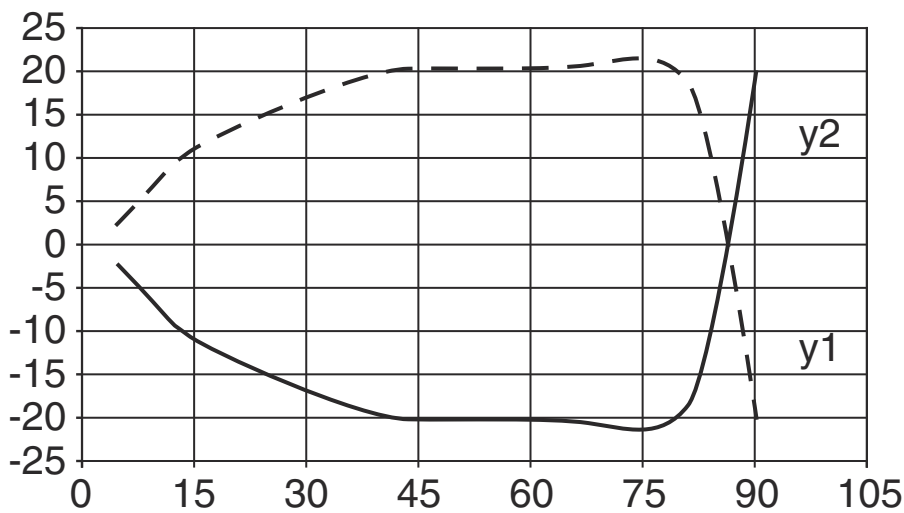

x Distance [mm]  
y Misalignment [mm]

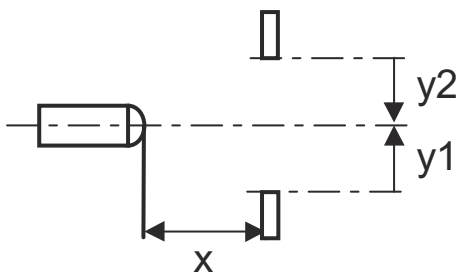

# Diagrams

Typ. black/white behavior

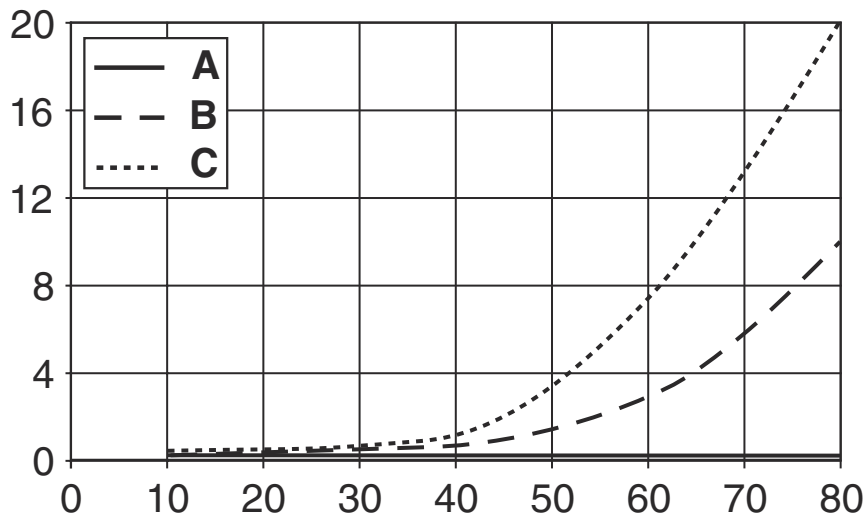

x Range [mm]  
 y Reduction of range [mm]  
 A White 90%  
 B Gray 18%  
 C Black 6%

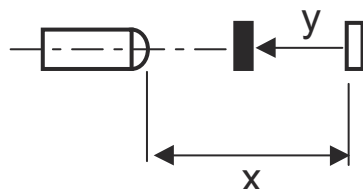

## Operation and display

| LED | Display                  | Meaning               |
|-----|--------------------------|-----------------------|
| 1   | Green, continuous light  | Operational readiness |
| 2   | Yellow, continuous light | Object detected       |

## Part number code

Part designation: AAA 3C d EE-f.GG H/i J-K

|              |  |
|--------------|--|
| <b>AAA3C</b> | <b>Operating principle / construction</b><br>HT3C: Diffuse reflection sensor with background suppression<br>LS3C: Throughbeam photoelectric sensor transmitter<br>LE3C: Throughbeam photoelectric sensor receiver<br>PRK3C: Retro-reflective photoelectric sensor with polarization filter<br>ODT3C: Distance diffuse sensor with background suppression |
| <b>d</b>     | <b>Light type</b><br>n/a: red light<br>I: infrared light   |
| <b>EE</b>    | <b>Light source</b><br>n/a: LED<br>L1: laser class 1<br>L2: laser class 2<br>PP: Power PinPoint LED  |
| <b>f</b>     | <b>Preset range (optional)</b><br>n/a: operating range acc. to data sheet<br>xxxF: Preset range [mm]<br>2M: operating range of 2 meters  |

## Part number code

|           |  |
|-----------|--|
| <b>GG</b> | <b>Equipment</b><br>n/a: standard<br>A: Autocollimation principle (single lens) for positioning tasks<br>B: Housing model with two M3 threaded sleeves, brass<br>F: Permanently set range<br>L: Long light spot<br>S: small light spot<br>T: autocollimation principle (single lens) for highly transparent bottles without tracking<br>TT: autocollimation principle (single lens) for highly transparent bottles with tracking<br>V: V-optics<br>XL: Extra long light spot<br>X: extended model<br>HF: Suppression of HF illumination (LED)  |
| <b>H</b>  | <b>Operating range adjustment</b><br>n/a with HT: range adjustable via 8-turn potentiometer<br>n/a with retro-reflective photoelectric sensors (PRK): operating range not adjustable<br>1: 270° potentiometer<br>3: teach-in via button<br>6: auto-teach   |
| <b>i</b>  | <b>Switching output/function OUT 1/IN: Pin 4 or black conductor</b><br>2: NPN transistor output, light switching<br>N: NPN transistor output, dark switching<br>4: PNP transistor output, light switching<br>P: PNP transistor output, dark switching<br>6: push-pull switching output, PNP light switching, NPN dark switching<br>G: Push-pull switching output, PNP dark switching, NPN light switching<br>L: IO-Link interface (SIO mode: PNP light switching, NPN dark switching)<br>8: activation input (activation with high signal)<br>X: pin not used<br>1: IO-Link / light switching (NPN) / dark switching (PNP) |
| <b>J</b>  | <b>Switching output / function OUT 2/IN: pin 2 or white conductor</b><br>2: NPN transistor output, light switching<br>N: NPN transistor output, dark switching<br>4: PNP transistor output, light switching<br>P: PNP transistor output, dark switching<br>6: push-pull switching output, PNP light switching, NPN dark switching<br>G: Push-pull switching output, PNP dark switching, NPN light switching<br>W: warning output<br>X: pin not used<br>8: activation input (activation with high signal)<br>9: deactivation input (deactivation with high signal)<br>T: teach-in via cable                                 |
| <b>K</b>  | <b>Electrical connection</b><br>n/a: cable, standard length 2000 mm, 4-wire<br>5000: cable, standard length 5000 mm, 4-wire<br>M8: M8 connector, 4-pin (plug)<br>M8.3: M8 connector, 3-pin (plug)<br>200-M8: cable, length 200 mm with M8 connector, 4-pin, axial (plug)<br>200-M8.3: cable, length 200 mm with M8 connector, 3-pin, axial (plug)<br>200-M12: cable, length 200 mm with M12 connector, 4-pin, axial (plug)   |

### Note



A list with all available device types can be found on the Leuze website at [www.leuze.com](http://www.leuze.com).

## Notes



### Observe intended use!



- ⚠ This product is not a safety sensor and is not intended as personnel protection.
- ⚠ The product may only be put into operation by competent persons.
- ⚠ Only use the product in accordance with its intended use.

## Notes

### For UL applications:





- For UL applications, use is only permitted in Class 2 circuits in accordance with the NEC (National Electric Code).
- These proximity switches shall be used with UL Listed Cable assemblies rated 30V, 0.5A min, in the field installation, or equivalent (categories: CYJV/ CYJV7 or PVVA/PVVA7)

## Further information

- Light source: Average life expectancy 100,000 h at an ambient temperature of 25 °C
- Response time: For short decay times, an ohmic load of approx. 5kOhm is recommended
- Sum of the output currents for both outputs, 50 mA for ambient temperatures > 40 °C
- The push-pull switching outputs must not be connected in parallel.

## Accessories

### Connection technology - Connection cables

|   | Part no. | Designation       | Article          | Description  |
|---|----------|-------------------|------------------|--|
|  | 50130850 | KD U-M8-4A-V1-050 | Connection cable | Connection 1: Connector, M8, Axial, Female, 4 -pin<br>Connector, LED: No<br>Connection 2: Open end<br>Shielded: No<br>Cable length: 5,000 mm<br>Sheathing material: PVC  |
|  | 50130871 | KD U-M8-4W-V1-050 | Connection cable | Connection 1: Connector, M8, Angled, Female, 4 -pin<br>Connector, LED: No<br>Connection 2: Open end<br>Shielded: No<br>Cable length: 5,000 mm<br>Sheathing material: PVC |

### Mounting technology - Mounting brackets

|   | Part no. | Designation | Article         | Description  |
|---|----------|-------------|-----------------|--|
|  | 50060511 | BT 3        | Mounting device | Design of mounting device: Angle, L-shape<br>Fastening, at system: Through-hole mounting<br>Mounting bracket, at device: Screw type<br>Type of mounting device: Rigid<br>Material: Metal |

## Accessories

### Mounting technology - Rod mounts

|   | Part no. | Designation  | Article         | Description  |
|---|----------|--------------|-----------------|--|
|  | 50117255 | BTU 200M-D12 | Mounting system | Design of mounting device: Mounting system<br>Fastening, at system: For 12 mm rod, Sheet-metal mounting<br>Mounting bracket, at device: Screw type, Suited for M3 screws<br>Type of mounting device: Clampable, Adjustable, Turning, 360°<br>Material: Metal |

#### Note



A list with all available accessories can be found on the Leuze website in the Download tab of the article detailed page.