

## Technical data sheet

### Polarized retro-reflective photoelectric sensor

Part no.: 50150360

PRK33CPP.TT3/LT-M8



For illustration purposes only

#### Contents

- Technical data
- Dimensioned drawings
- Electrical connection
- Diagrams
- Operation and display
- Reflectors & reflective tapes
- Part number code
- Notes
- Further information
- Accessories



## Technical data

### Basic data

Series	33C
Operating principle	Reflection principle
Application	Detection of highly transparent bottles Detection of transparent films

### Special version

Special version	Autocollimation Teach input Tracking function
-----------------	---

### Optical data

Operating range	0 ... 3 m, With reflector TK(S) 100x100
Operating range	Guaranteed operating range
Operating range limit	0 ... 3.6 m, With reflector TK(S) 100x100
Operating range limit	Typical operating range
Light source	Power PinPoint LED, Red
Wavelength	645 nm
Transmitted-signal shape	Pulsed
LED group	Exempt group (in acc. with EN 62471)

### Electrical data

Protective circuit	Polarity reversal protection Short circuit protected
--------------------	---

#### Performance data

Supply voltage $U_B$	10 ... 30 V, DC, Incl. residual ripple
Residual ripple	0 ... 15 %, From $U_B$
Open-circuit current	0 ... 20 mA

#### Inputs

Number of teach inputs	1 Piece(s)
------------------------	------------

#### Teach inputs

Voltage type	DC
Switching voltage	high: $\geq 10V$ low: $\leq 2 V$
Input resistance	22,000 $\Omega$

#### Teach input 1

Assignment	Connection 1, pin 2
Function	Sensitivity adjustment
Active switching state	High

#### Outputs

Number of digital switching outputs	1 Piece(s)
-------------------------------------	------------

#### Switching outputs

Voltage type	DC
Switching current, max.	100 mA
Switching voltage	high: $\geq (U_B - 2.5V)$ low: $\leq 2.5 V$

#### Switching output 1

Assignment	Connection 1, pin 4
Switching element	Transistor, Push-pull
Switching principle	IO-Link / light switching (PNP)/dark switching (NPN)

### Time behavior

Switching frequency	1,500 Hz
Response time	0.33 ms
Readiness delay	300 ms

### Interface

Type	IO-Link
IO-Link	
COM mode	COM2
Profile	Smart sensor profile
Min. cycle time	COM2 = 2.3 ms
Frame type	2.5
Specification	V1.1
Device ID	6139
SIO-mode support	Yes

### Connection

#### Connection 1

Function	Signal IN Signal OUT Voltage supply
Type of connection	Connector
Thread size	M8
Type	Male
Material	Stainless steel
No. of pins	4 -pin

### Mechanical data

Dimension (W x H x L)	18.8 mm x 52.8 mm x 32.4 mm
Housing material	Stainless steel
Material of operational control	Plastic (POM Hostaform C9021, copolyester Tritan TX1001), non-diffusive
Housing roughness	$R_a \leq 0,8$ , Typical value for the stainless steel housing
Stainless steel housing	AISI 316L, DIN X2CrNiMo17132, W. No1.4404
Lens cover material	Plastic (PMMA+) with scratch-resistant Indium protective coating
Net weight	120 g
Housing color	Silver
Type of fastening	Housing fit
Compatibility of materials	CleanProof+ ECOLAB Johnson Diversey

### Operation and display

Type of display	LED
Number of LEDs	2 Piece(s)
Operational controls	Teach button
Function of the operational control	Sensitivity adjustment

### Environmental data

Ambient temperature, operation	-40 ... 70 °C
Ambient temperature, storage	-40 ... 70 °C

## Technical data

### Certifications

Degree of protection	IP 67
	IP 68
	IP 69K
Protection class	III
Approvals	c UL US
Standards applied	IEC 60947-5-2

### Classification

Customs tariff number	85365019
ECLASS 5.1.4	27270902
ECLASS 8.0	27270902
ECLASS 9.0	27270902
ECLASS 10.0	27270902
ECLASS 11.0	27270902
ECLASS 12.0	27270902
ECLASS 13.0	27270902
ECLASS 14.0	27270902
ECLASS 15.0	27270902
ETIM 5.0	EC002717
ETIM 6.0	EC002717
ETIM 7.0	EC002717
ETIM 8.0	EC002717
ETIM 9.0	EC002717
ETIM 10.0	EC002717

## Dimensioned drawings

All dimensions in millimeters

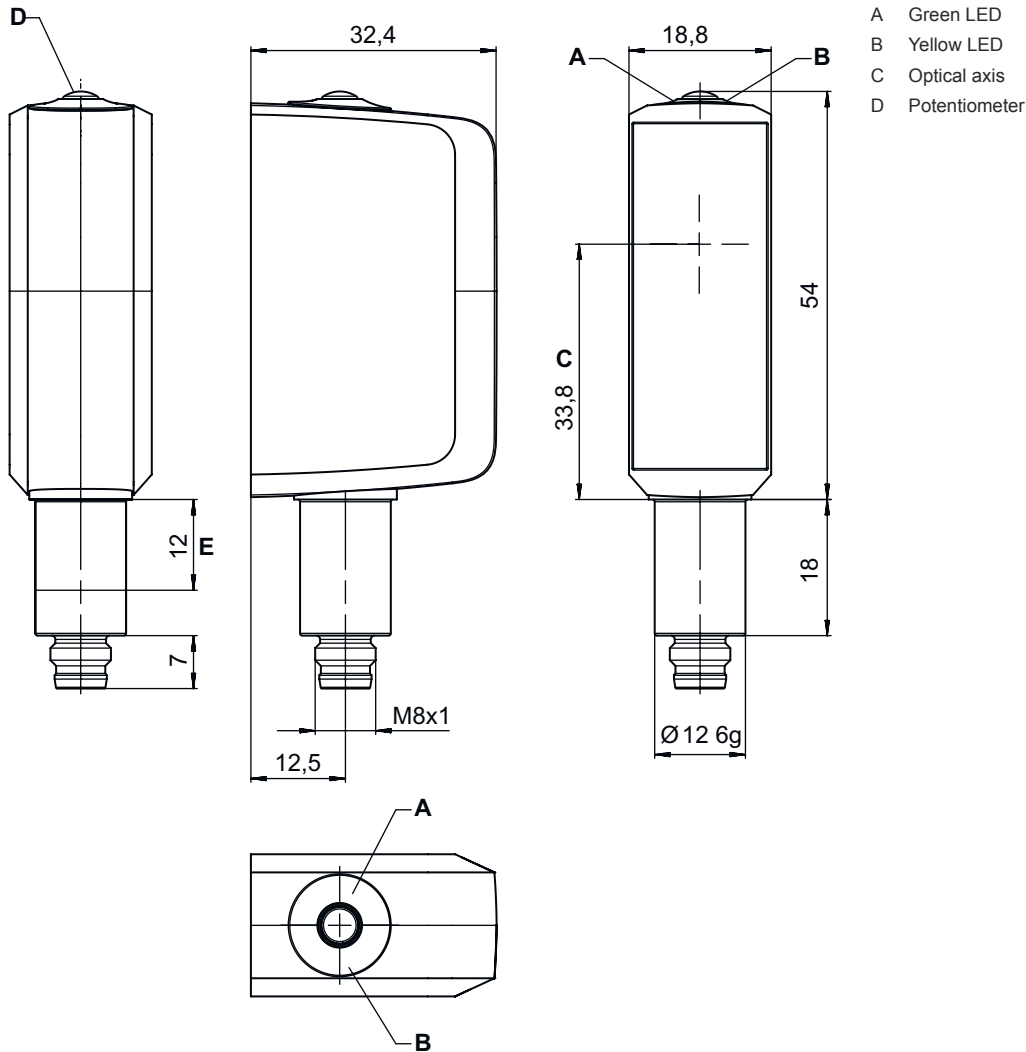

## Electrical connection

### Connection 1

<b>Function</b>	Signal IN
	Signal OUT
	Voltage supply
<b>Type of connection</b>	Connector
<b>Thread size</b>	M8
<b>Type</b>	Male
<b>Material</b>	Stainless steel
<b>No. of pins</b>	4 -pin

### Pin Pin assignment

<b>1</b>	V+
<b>2</b>	Teach-in
<b>3</b>	GND
<b>4</b>	IO-Link / OUT 1



# Diagrams

Typ. response behavior (TKS100x100)

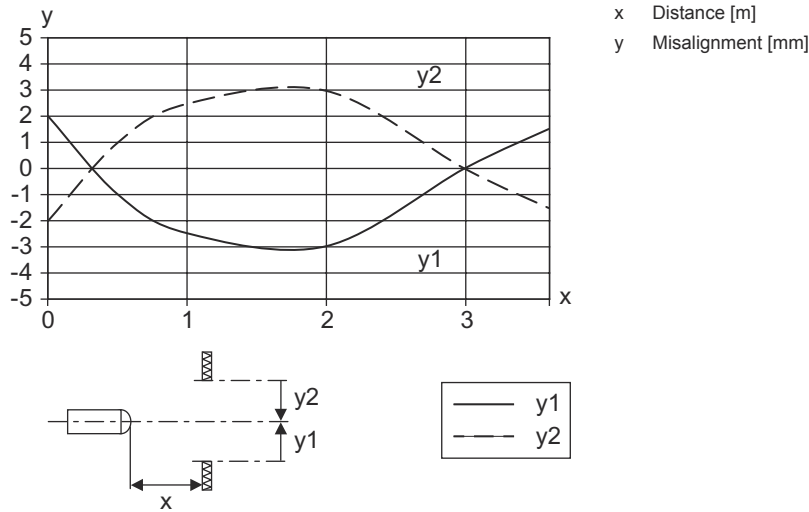









## Operation and display

LED	Display	Meaning
1	Green, continuous light	Operational readiness
2	Yellow, continuous light	Light path free

## Reflectors & reflective tapes

	Part no.	Designation	Operating range Operating range limit	Description
	50136824	MTKS 12x20M.5	0 ... 0.7 m 0 ... 0.85 m	Design: Rectangular Triple reflector size: 0.3 mm Reflective surface: 12 mm x 20 mm Material: Plastic Base material: Stainless steel Fastening: Through-hole mounting Compatibility of materials: Alcohol, CleanProof+, ECOLAB, H2O2
	50106961	MTKS 14x23.P	0 ... 0.6 m 0 ... 0.7 m	Design: Rectangular Triple reflector size: 12 mm Reflective surface: 11 mm x 21 mm Material: Plastic Base material: Plastic Chemical designation of the material: PES Fastening: Through-hole mounting, Adhesive Compatibility of materials: ECOLAB
	50151449	MTKS 20x20.SC	0 ... 0.15 m 0 ... 0.2 m	Design: Rectangular Triple reflector size: 1.1 mm Reflective surface: 20 mm x 20 mm Material: Plastic Base material: Plastic Chemical designation of the material: Solidchem Fastening: Through-hole mounting, Adhesive Compatibility of materials: Alcohol, ECOLAB, H2O2

## Reflectors & reflective tapes

	Part no.	Designation	Operating range Operating range limit	Description
	50117583	MTKS 50x50.1	0 ... 2 m 0 ... 2.4 m	Design: Rectangular Triple reflector size: 1.2 mm Reflective surface: 50 mm x 50 mm Material: Plastic Base material: Plastic Chemical designation of the material: PMMA8N Fastening: Through-hole mounting, Adhesive
	50136823	MTKS 7x7M.5	0 ... 0.4 m 0 ... 0.5 m	Design: Rectangular Triple reflector size: 0.3 mm Reflective surface: 7 mm x 7 mm Material: Plastic Base material: Stainless steel Fastening: Through-hole mounting Compatibility of materials: Alcohol, CleanProof+, ECOLAB, H2O2
	50108300	REF 4-A-50x50	0 ... 0.5 m 0 ... 0.6 m	Design: Rectangular Reflective surface: 50 mm x 50 mm Material: Plastic Chemical designation of the material: PMMA Fastening: Self-adhesive
	50110192	REF 6-A-50x50	0 ... 1.3 m 0 ... 1.5 m	Design: Rectangular Triple reflector size: 0.3 mm Reflective surface: 50 mm x 50 mm Material: Plastic Chemical designation of the material: PMMA Fastening: Self-adhesive
	50116939	TK 10.P	0 ... 0.3 m 0 ... 0.4 m	Design: Round Triple reflector size: 1.5 mm Reflective surface, diameter: 8.5 mm Material: Plastic Base material: Plastic Chemical designation of the material: PES Fastening: Rear side can be glued Compatibility of materials: ECOLAB
	50022816	TKS 100X100	0 ... 3 m 0 ... 3.6 m	Design: Rectangular Triple reflector size: 4 mm Reflective surface: 96 mm x 96 mm Material: Plastic Base material: Plastic Chemical designation of the material: PMMA8N Fastening: Through-hole mounting, Adhesive
	50106958	TKS 20.P	0 ... 0.55 m 0 ... 0.7 m	Design: Round Triple reflector size: 2.3 mm Reflective surface, diameter: 17 mm Material: Plastic Base material: Plastic Chemical designation of the material: PES Fastening: M4 threaded pin Compatibility of materials: ECOLAB
	50081283	TKS 20X40	0 ... 1.1 m 0 ... 1.3 m	Design: Rectangular Triple reflector size: 2.3 mm Reflective surface: 16 mm x 38 mm Material: Plastic Base material: Plastic Chemical designation of the material: PMMA8N Fastening: Through-hole mounting, Adhesive

## Reflectors & reflective tapes

	Part no.	Designation	Operating range Operating range limit	Description
	50106960	TKS 20x40.P	0 ... 0.8 m 0 ... 1 m	Design: Rectangular Triple reflector size: 2.3 mm Reflective surface: 16 mm x 38 mm Material: Plastic Base material: Plastic Chemical designation of the material: PES Fastening: Through-hole mounting, Adhesive Compatibility of materials: ECOLAB
	50040820	TKS 40X60	0 ... 2 m 0 ... 2.4 m	Design: Rectangular Triple reflector size: 4 mm Reflective surface: 37 mm x 56 mm Material: Plastic Base material: Plastic Chemical designation of the material: PMMA8N Fastening: Through-hole mounting, Adhesive
	50120538	TKS 40x60.1.AF	0 ... 1.9 m 0 ... 2.3 m	Special version: Anti-fog coating Design: Rectangular Triple reflector size: 2.3 mm Reflective surface: 37 mm x 56 mm Material: Plastic Base material: Plastic Chemical designation of the material: PMMA8N Fastening: Through-hole mounting, Adhesive
	50136383	TKS 40x60.Chem	0 ... 1.5 m 0 ... 1.8 m	Design: Rectangular Triple reflector size: 4 mm Reflective surface: 37 mm x 56 mm Material: Plastic Base material: Plastic Chemical designation of the material: PET Fastening: Through-hole mounting, Adhesive Compatibility of materials: Alcohol, ECOLAB, H2O2
	50106957	TKS 40x60.P	0 ... 1.5 m 0 ... 1.8 m	Design: Rectangular Triple reflector size: 4 mm Reflective surface: 37 mm x 56 mm Material: Plastic Base material: Plastic Chemical designation of the material: PES Fastening: Through-hole mounting, Adhesive Compatibility of materials: ECOLAB
	50151448	TKS 50x50.1.SC	0 ... 0.8 m 0 ... 1 m	Design: Rectangular Triple reflector size: 4 mm Reflective surface: 51.3 mm x 51.2 mm Material: Plastic Base material: Plastic Chemical designation of the material: Solidchem Fastening: Adhesive, Through-hole mounting Compatibility of materials: Alcohol, ECOLAB, H2O2

## Part number code

Part designation: AAA33C d EE.GGH/IJ-K

<b>AAA33C</b>	<b>Operating principle</b> LS33C: Throughbeam photoelectric sensor transmitter LE33C: Throughbeam photoelectric sensor receiver PRK33C: Retro-reflective photoelectric sensor with polarization filter HT33C: Diffuse reflection sensor with background suppression DRT33C: Dynamic reference diffuse sensor
<b>d</b>	<b>Light type</b> n/a: red light l: infrared light
<b>EE</b>	<b>Light source</b> n/a: LED PP: Power PinPoint LED L1: laser class 1

## Part number code

<b>GG</b>	<b>Equipment</b> A: Autocollimation principle (single lens) D: Detection of stretch-wrapped objects X: extended model XL: Extra long light spot TT: autocollimation principle (single lens) for highly transparent bottles with tracking R: greater operating range XXR: super power transmitter
<b>H</b>	<b>Operating range adjustment</b> 1: 270° potentiometer 2: multiturn potentiometer 3: teach-in via button
<b>i</b>	<b>Switching output/function OUT 1/IN: Pin 4 or black conductor</b> X: pin not used 8: activation input (activation with high signal) L: IO-Link interface (SIO mode: PNP light switching, NPN dark switching)
<b>J</b>	<b>Switching output / function OUT 2/IN: pin 2 or white conductor</b> T: teach-in via cable G: Push-pull switching output, PNP dark switching, NPN light switching X: pin not used
<b>K</b>	<b>Electrical connection</b> M8: M8 connector, 4-pin (plug)

### Note



A list with all available device types can be found on the Leuze website at [www.leuze.com](http://www.leuze.com).

## Notes



### Observe intended use!



- ⌘ This product is not a safety sensor and is not intended as personnel protection.
- ⌘ The product may only be put into operation by competent persons.
- ⌘ Only use the product in accordance with its intended use.

## Further information

- Ambient temperature, operation: +70 °C permissible only briefly (≤ 15min)
- IP 69K only with internal tube installation of M8 connector
- Light source: Average life expectancy 100,000h at an ambient temperature of 25 °C
- Sum of the output currents for both outputs 100 mA





## Accessories

### Connection technology - Connection unit

	Part no.	Designation	Article	Description
	50144900	MD 798i-11-82/L5-2222	IO-Link master	Type: IO-Link master Current consumption, max.: 11,000 mA Switching outputs for each sensor connection: 1 Piece(s) Switching output: Transistor, PNP Interface: IO-Link, Automatic protocol detection, EtherNet IP, Modbus TCP, PROFINET Connections: 12 Piece(s) Sensor connections: 8 Piece(s) Connections for voltage supply: 2 Piece(s) Interface connections: 2 Piece(s) Degree of protection: IP 67, IP 65, IP 69K

### Connection technology - Connection cables

	Part no.	Designation	Article	Description
	50106153	K-D M8A-4P-5m-FAB	Connection cable	Connection 1: Connector, M8, Axial, Female, 4 -pin Connector, LED: No Connection 2: Open end Shielded: No Cable length: 5,000 mm Sheathing material: PVC
	50148347	KD U-M8-4A-T0-050 F+B	Connection cable	Connection 1: Connector, M8, Axial, Female, A-coded, 4 -pin Connector, LED: No Connection 2: Open end Shielded: No Cable length: 5,000 mm Sheathing material: TPE
	50130850	KD U-M8-4A-V1-050	Connection cable	Connection 1: Connector, M8, Axial, Female, 4 -pin Connector, LED: No Connection 2: Open end Shielded: No Cable length: 5,000 mm Sheathing material: PVC

### Mounting technology - Other

	Part no.	Designation	Article	Description
	50145361	BTU 053M.5F-D12-T	Mounting system	Design of mounting device: Mounting system Fastening, at system: Screw type Mounting bracket, at device: For 12 mm rod Type of mounting device: Turning, 360°, Adjustable Material: Stainless steel

#### Note



A list with all available accessories can be found on the Leuze website in the Download tab of the article detailed page.