

## Technical data sheet

### Inductive switch

Part no.: 50153132

IS D18MM/4NC-8E0-M12

#### Contents

- Technical data
- Dimensioned drawings
- Electrical connection
- Diagrams
- Operation and display
- Part number code
- Notes
- Accessories



For illustration purposes only



## Technical data

### Basic data

Series	D18
type. operating range limit $S_n$	8 mm
Operating range $S_a$	0 ... 6.4 mm

### Characteristic parameters

MTTF	300 years
------	-----------

### Electrical data

Protective circuit	Inductive protection
	Polarity reversal protection
	Short circuit protected

### Performance data

Supply voltage $U_B$	10 ... 30 V, DC
Residual ripple	0 ... 10 %, From $U_B$
Open-circuit current	0 ... 15 mA
Temperature drift, max. (in % of $S_r$ )	15 %, Over the entire operating temperature range
Repeatability, max. (in % of $S_r$ )	5 %, For $U_B = 20 ... 30$ VDC, ambient temperature $T_a = 23^\circ\text{C} \pm 5^\circ\text{C}$
Switching hysteresis	15 %

### Outputs

Number of digital switching outputs	1 Piece(s)
-------------------------------------	------------

### Switching outputs

Voltage type	DC
Switching current, max.	200 mA
Residual current, max.	0.1 mA
Voltage drop	$\leq 2.5$ V

### Switching output 1

Switching element	Transistor, PNP
Switching principle	NC (normally closed)

### Time behavior

Switching frequency	500 Hz
Readiness delay	100 ms

### Connection

Number of connections	1 Piece(s)
-----------------------	------------

### Connection 1

Function	Signal OUT
	Voltage supply
Type of connection	Connector
Thread size	M12
Type	Male
Material	Metal
No. of pins	4 -pin
Encoding	A-coded

### Mechanical data

Design	Cylindrical
Dimension ( $\varnothing \times L$ )	18 mm x 60 mm
Thread size	M18 x 1 mm
Type of installation	Embedded
Housing material	Metal
Metal housing	Copper-nickel alloy
Sensing face material	Plastic, Polybutylene (PBT)
Net weight	25 g
Housing color	Red, RAL 3000
	Silver
Type of fastening	Mounting thread
Standard measuring plate	24 x 24 mm <sup>2</sup> , Fe360

### Operation and display

Type of display	LED
Number of LEDs	1 Piece(s)

### Environmental data

Ambient temperature, operation	-25 ... 70 °C
Ambient temperature, storage	-25 ... 70 °C

### Certifications

Degree of protection	IP 67
Protection class	II
Approvals	c UL US
Test procedure for EMC in accordance with standard	IEC 61000-4-2
	IEC 61000-4-3
	IEC 61000-4-4
Standards applied	IEC 60947-5-2

### Correction factors

Aluminum	0.43
Stainless steel	0.71
Copper	0.35
Brass	0.47
Fe360 steel	1

### Classification

Customs tariff number	85365019
ECLASS 5.1.4	27270101
ECLASS 8.0	27270101
ECLASS 9.0	27270101
ECLASS 10.0	27270101
ECLASS 11.0	27270101
ECLASS 12.0	27274001
ECLASS 13.0	27274001
ECLASS 14.0	27274001
ECLASS 15.0	27274001
ETIM 5.0	EC002714
ETIM 6.0	EC002714
ETIM 7.0	EC002714
ETIM 8.0	EC002714
ETIM 9.0	EC002714
ETIM 10.0	EC002714

# Dimensioned drawings

All dimensions in millimeters

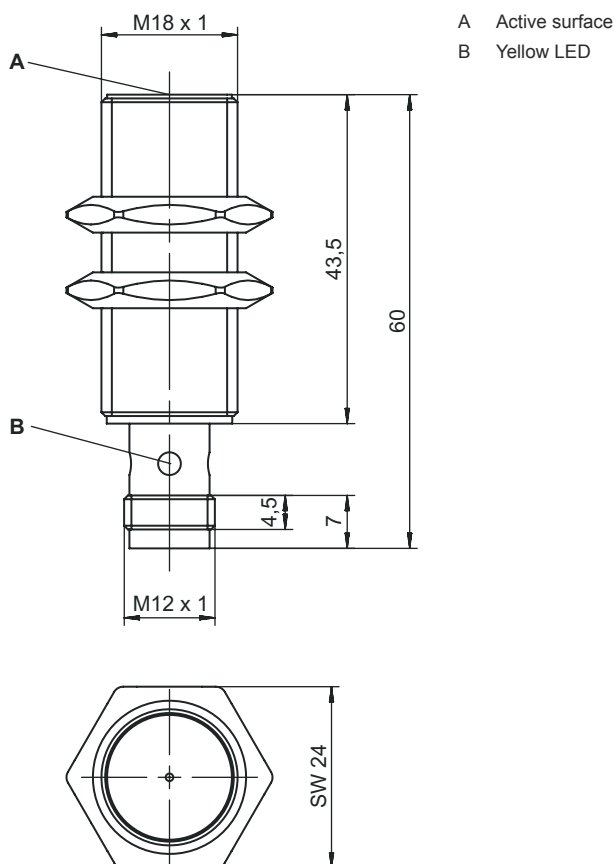

## Electrical connection

### Connection 1

Function	Signal OUT
	Voltage supply
Type of connection	Connector
Thread size	M12
Type	Male
Material	Metal
No. of pins	4 -pin
Encoding	A-coded

Pin	Pin assignment
1	V+
2	n.c.
3	GND
4	OUT 1

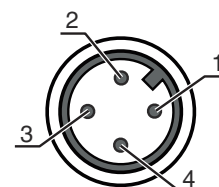

# Diagrams

## Embedded installation

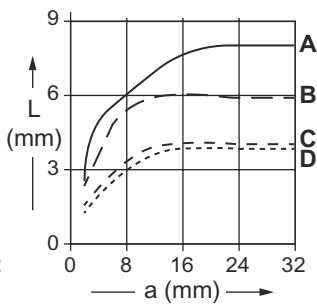
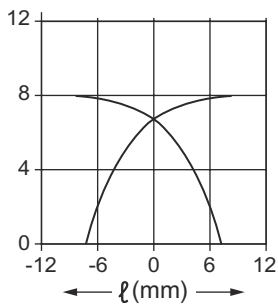
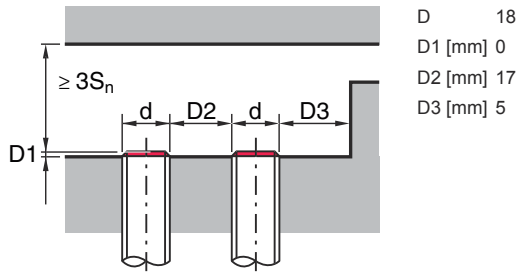

24mm x 24mm x t1mm

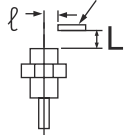

amm x amm x t1mm

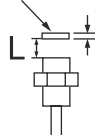

## Operation and display

LED	Display	Meaning
1	Yellow, continuous light	Switching output/switching state

## Part number code

Part designation: IS AAABB/CCC-DDD-EEE

<b>IS</b>	<b>Operating principle / construction</b> IS: inductive switch, standard design
<b>AAA</b>	<b>Series</b> D08: series with M8 x 1 external thread D12: series with M12 x 1 external thread D18: series with M18 x 1 external thread D22: series in cubic design with 18 x 18 mm D30: series with M30 x 1.5 external thread
<b>BB</b>	<b>Housing</b> MM: metal housing (active surface: plastic) / metric thread PP: Plastic housing
<b>CCC</b>	<b>Output current / supply</b> 2NC: NPN transistor, NC contact 2NO: NPN transistor, NO contact 4NC: PNP transistor, NC contact 4NO: PNP transistor, NO contact

## Part number code

<b>DDD</b>	<b>Measurement range / type of installation</b> 2E0: typ. range limit 2.0 mm / embedded installation 2N5: typ. range limit 2.5 mm / non-embedded installation 4E0: typ. range limit 4.0 mm / embedded installation 4N0: typ. range limit 4.0 mm / non-embedded installation 5E0: typ. range limit 5.0 mm / embedded installation 8E0: typ. range limit 8.0 mm / embedded installation 8N0: typ. range limit 8.0 mm / non-embedded installation 10E: typ. range limit 10.0 mm / embedded installation 12N: typ. range limit 12.0 mm / non-embedded installation 15E: typ. range limit 15.0 mm / embedded installation 15N: typ. range limit 15.0 mm / non-embedded installation 16N: typ. range limit 16.0 mm / non-embedded installation 30N: typ. range limit 30.0 mm / non-embedded installation
<b>EEE</b>	<b>Electrical connection</b> n/a: cable, standard length 2000 mm, 3-wire M8.3: M8 connector, 3-pin (plug) M12: M12 connector, 4-pin (plug)

Note	
	↪ A list with all available device types can be found on the Leuze website at <a href="http://www.leuze.com">www.leuze.com</a> .

## Notes

⚠ Observe intended use!	
	↪ This product is not a safety sensor and is not intended as personnel protection. ↪ The product may only be put into operation by competent persons. ↪ Only use the product in accordance with its intended use.

⚠ For UL applications:	
	↪ For UL applications, use is only permitted in Class 2 circuits in accordance with the NEC (National Electric Code).

## Accessories

### Connection technology - Connection cables

	Part no.	Designation	Article	Description
	50130654	KD U-M12-4A-P1-020	Connection cable	Connection 1: Connector, M12, Axial, Female, A-coded, 4 -pin Connector, LED: No Connection 2: Open end Shielded: No Cable length: 2.000 mm Sheathing material: PUR

## Accessories

	Part no.	Designation	Article	Description
	50130657	KD U-M12-4A-P1-050	Connection cable	Connection 1: Connector, M12, Axial, Female, A-coded, 4 -pin Connector, LED: No Connection 2: Open end Shielded: No Cable length: 5.000 mm Sheathing material: PUR
	50130648	KD U-M12-4A-V1-020	Connection cable	Connection 1: Connector, M12, Axial, Female, A-coded, 4 -pin Connector, LED: No Connection 2: Open end Shielded: No Cable length: 2.000 mm Sheathing material: PVC
	50130688	KD U-M12-4W-V1-020	Connection cable	Connection 1: Connector, M12, Angled, Female, A-coded, 4 -pin Connector, LED: No Connection 2: Open end Shielded: No Cable length: 2.000 mm Sheathing material: PVC

## Mounting technology - Other

	Part no.	Designation	Article	Description
	50111501	MC 018K	Clamp	Diameter, inner: 18 mm Design of mounting device: Mounting clamp Fastening, at system: Through-hole mounting Mounting bracket, at device: Clampable Type of mounting device: Rigid Material: Plastic

### Note



A list with all available accessories can be found on the Leuze website in the Download tab of the article detailed page.