

## Technical data sheet

### Contrast sensor

Part no.: 50148505

KRT3CW.L3S2/LG-M8

#### Contents

- Technical data
- Dimensioned drawings
- Electrical connection
- Operation and display
- Part number code
- Notes
- Further information
- Accessories



For illustration purposes only



# Technical data

## Basic data

Series	3C
--------	----

## Special version

Special version	Time function
-----------------	---------------

## Optical data

Operating range	14.5 mm ± 2 mm
Beam path	Focused
Light source	LED, White
Transmitted-signal shape	Pulsed
LED group	Exempt group (in acc. with EN 62471)
Light spot size [at sensor distance]	1.5 mm x 4 mm [14.5 mm]
Light spot orientation	Vertical
Type of light spot geometry	Rectangular
Light beam exit	Front
Focus	Fixed
Wavelength	400 ... 750 nm

## Measurement data

Repeatability	0.02 mm
---------------	---------

## Electrical data

Protective circuit	Polarity reversal protection Short circuit protected
--------------------	---

### Performance data

Supply voltage $U_B$	12 ... 30 V, DC, Incl. residual ripple
Residual ripple	0 ... 15 %, From $U_B$
Open-circuit current	0 ... 25 mA

### Outputs

Number of digital switching outputs	2 Piece(s)
-------------------------------------	------------

### Switching outputs

Voltage type	DC
Switching current, max.	90 mA
Switching voltage	high: $\geq(U_B - 2V)$ low: $\leq 2 V$

### Switching output 1

Assignment	Connection 1, pin 4
Switching element	Transistor, Push-pull
Switching principle	IO-Link / light switching (PNP)/dark switching (NPN)

### Switching output 2

Assignment	Connection 1, pin 2
Switching element	Transistor, Push-pull
Switching principle	Dark switching (PNP)/light switching (NPN)

## Time behavior

Switching frequency	10,000 Hz
Response time	0.05 ms
Readiness delay	300 ms
Response jitter	20 $\mu$ s

## Interface

Type	IO-Link
------	---------

## IO-Link

COM mode	COM3
Profile	Smart sensor profile
Min. cycle time	COM3 = 0.6 ms
Frame type	2.V
Specification	V1.1.3
Device ID	3220
SIO-mode support	Yes

## Connection

### Connection 1

Function	Signal OUT Voltage supply
Type of connection	Connector
Thread size	M8
Type	Male
Material	Metal
No. of pins	4 -pin

## Mechanical data

Design	Cubic
Dimension (W x H x L)	11.4 mm x 34.2 mm x 18.3 mm
Housing material	Plastic
Plastic housing	PC-ABS
Lens cover material	Plastic / PMMA
Net weight	10 g
Housing color	Red
Type of fastening	Via optional mounting device
Compatibility of materials	ECOLAB

## Operation and display

Type of display	LED
Number of LEDs	2 Piece(s)
Operational controls	Teach button
Function of the operational control	Setting the pulse stretching Switching-threshold adjustment Teach-in

## Environmental data

Ambient temperature, operation	-40 ... 60 °C
Ambient temperature, storage	-40 ... 70 °C

## Certifications

Degree of protection	IP 67 IP 69K
Protection class	III
Approvals	c UL US
Standards applied	IEC 60947-5-2

# Technical data

Customs tariff number	85365019
ECLASS 5.1.4	27270906
ECLASS 8.0	27270906
ECLASS 9.0	27270906
ECLASS 10.0	27270906
ECLASS 11.0	27270906
ECLASS 12.0	27270906
ECLASS 13.0	27270906
ECLASS 14.0	27270906
ECLASS 15.0	27270906
ETIM 5.0	EC001820
ETIM 6.0	EC001820
ETIM 7.0	EC001820
ETIM 8.0	EC001820
ETIM 9.0	EC001820
ETIM 10.0	EC001820

# Dimensioned drawings

All dimensions in millimeters

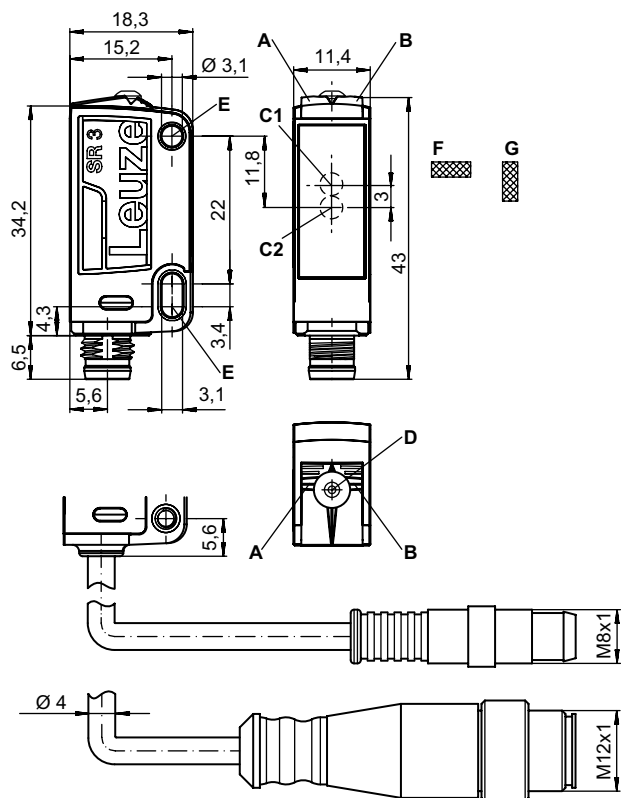

- A Green LED
- B Yellow LED
- C1 Optical axis (receiver)
- C2 Optical axis (transmitter)
- D Teach button
- E Mounting sleeve
- F Light spot orientation horizontal
- G Light spot orientation vertical

# Electrical connection

## Connection 1

Function	Signal OUT Voltage supply
Type of connection	Connector
Thread size	M8
Type	Male
Material	Metal
No. of pins	4 -pin

Pin	Pin assignment
1	V+
2	OUT 2
3	GND
4	IO-Link / OUT 1

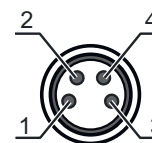

# Operation and display

Display LED 1	Display LED 2	Meaning
Green, continuous light	Off	Operational readiness
Green, flashing, 3 Hz	Yellow, flashing, 3 Hz	Teach event active
Green, flashing, 15 Hz	Yellow, flashing, 15 Hz	Teach error
Green, continuous light	Yellow, continuous light	Mark detected

# Part number code

Part designation: **KRT3C A.BCDD/EF-G**

<b>KRT3C</b>	<b>Operating principle</b> KRT3C: Contrast sensor
<b>A</b>	<b>Light type</b> M: LED, multicolor W: White light L1: laser class 1
<b>B</b>	<b>Light spot orientation</b> L: vertical Q: horizontal
<b>C</b>	<b>Control button</b> 3: teach-in via button
<b>DD</b>	<b>Teach mode</b> S1: Static 1-point teach S2: Static 2-point teach D2: Dynamic 2-point teach
<b>E</b>	<b>Switching output/function OUT 1/IN: Pin 4 or black conductor</b> 2: NPN transistor output, light switching 4: PNP transistor output, light switching 6: push-pull switching output, PNP light switching, NPN dark switching L: IO-Link / light switching (PNP)/dark switching (NPN)
<b>F</b>	<b>Switching output / function OUT 2/IN: pin 2 or white conductor</b> G: Push-pull switching output, PNP dark switching, NPN light switching T: teach-in via cable
<b>G</b>	<b>Electrical connection</b> n/a: cable, standard length 2000 mm, 4-wire M8: M8 connector, 4-pin (plug) 200-M12: cable, length 200 mm with M12 connector, 4-pin, axial (plug) 200-M8: cable, length 200 mm with M8 connector, 4-pin, axial (plug)

### Note



A list with all available device types can be found on the Leuze website at [www.leuze.com](http://www.leuze.com).

## Notes

**⚠ Observe intended use!**

**⚠**

- ⌘ This product is not a safety sensor and is not intended as personnel protection.
- ⌘ The product may only be put into operation by competent persons.
- ⌘ Only use the product in accordance with its intended use.

**⚠ For UL applications:**

**⚠**

- ⌘ For UL applications, use is only permitted in Class 2 circuits in accordance with the NEC (National Electric Code).

## Further information



- Sum of the output currents for both outputs, 50 mA for ambient temperatures > 40 °C

## Accessories

### Connection technology - Connection unit

	Part no.	Designation	Article	Description
	50144900	MD 798i-11-82/L5-2222	IO-Link master	Type: IO-Link master Current consumption, max.: 11,000 mA Switching outputs for each sensor connection: 1 Piece(s) Switching output: Transistor, PNP Interface: IO-Link, Automatic protocol detection, EtherNet IP, Modbus TCP, PROFINET Connections: 12 Piece(s) Sensor connections: 8 Piece(s) Connections for voltage supply: 2 Piece(s) Interface connections: 2 Piece(s) Degree of protection: IP 67, IP 65, IP 69K

### Connection technology - Connection cables



	Part no.	Designation	Article	Description
	50130850	KD U-M8-4A-V1-050	Connection cable	Connection 1: Connector, M8, Axial, Female, 4 -pin Connector, LED: No Connection 2: Open end Shielded: No Cable length: 5.000 mm Sheathing material: PVC
	50130871	KD U-M8-4W-V1-050	Connection cable	Connection 1: Connector, M8, Angled, Female, 4 -pin Connector, LED: No Connection 2: Open end Shielded: No Cable length: 5.000 mm Sheathing material: PVC

## Accessories

### Mounting technology - Mounting brackets

	Part no.	Designation	Article	Description
	50105546	BT 3B	Mounting device	Design of mounting device: Angle, L-shape Fastening, at system: Through-hole mounting Mounting bracket, at device: Screw type Type of mounting device: Rigid Material: Metal

### Mounting technology - Rod mounts

	Part no.	Designation	Article	Description
	50117829	BTP 200M-D12	Mounting system	Design of mounting device: Protection hood Fastening, at system: For 12 mm rod Mounting bracket, at device: Screw type Type of mounting device: Clampable, Adjustable, Turning, 360° Material: Metal
	50117255	BTU 200M-D12	Mounting system	Design of mounting device: Mounting system Fastening, at system: For 12 mm rod, Sheet-metal mounting Mounting bracket, at device: Screw type, Suited for M3 screws Type of mounting device: Clampable, Adjustable, Turning, 360° Material: Metal

#### Note



A list with all available accessories can be found on the Leuze website in the Download tab of the article detailed page.