

Technical data sheet

Tower light

Part no.: 50149098

TL305-3MC-BZ-IOL-M12

Contents

- Technical data
- Dimensioned drawings
- Electrical connection
- Diagrams
- Accessories



For illustration purposes only



Technical data

Basic data

Series	TL 305-IOL
Contains	1x M30 nut 1x rubber flat seal
Type of signaling	Optical and acoustic

Optical data

Adjustable light intensity	10 ... 100%, via IO-Link
----------------------------	--------------------------

Electrical data

Performance data

Supply voltage U_B	18 ... 30 V, DC
Current consumption, max.	195 mA

Inputs

Number of digital switching inputs	3 Piece(s)
------------------------------------	------------

Switching inputs

Type	Digital switching input
Switching voltage high, min.	8 V
Switching voltage low, max.	5 V
Voltage type	DC

Digital switching input 1

Function	External trigger mode: 8 color presets Trigger 1
----------	-----------------------------------------------------

Digital switching input 2

Function	External trigger mode: 8 color presets Trigger 2
----------	-----------------------------------------------------

Digital switching input 3

Function	External trigger mode: 8 color presets Trigger 3
----------	-----------------------------------------------------

Interface

Type	IO-Link
IO-Link	
Function	Four operating modes, color and buzzer configuration
COM mode	COM2
Min. cycle time	COM2 = 5 ms
Frame type	TYPE_2_V
Specification	V1.1
Device ID	5001
SIO-mode support	Yes

Connection

Number of connections	1 Piece(s)
-----------------------	------------

Connection 1

Function	IO-Link Light color via control of pins (external trigger mode) Signal IN Voltage supply
Type of connection	Connector
Thread size	M12
Type	Male
Material	Metal
No. of pins	5 -pin
Encoding	A-coded

Mechanical data

Design	Cylindrical
Dimension (\varnothing x L)	50.6 mm x 184 mm
Thread size	M30 x 1.5 mm
Housing material	Metal
Metal housing	Aluminium, anodized
Light area material	PolycarbonatePlastic
Net weight	310 g
Housing color	Gray
Type of illuminant	LED/24V
Lens modules	3 pieces, ready-made
Signal image	Continuous, blinking, flashing light
Angle of radiation	360°
Sequence of the modules (ascending)	User defined via IO-Link: RGB color space, Factory settings: red, green, yellow, blue, white, orange, pink

Environmental data

Ambient temperature, operation	0 ... 50 °C
Ambient temperature, storage	0 ... 50 °C

Certifications

Degree of protection	IP 20
Protection class	III
Approvals	UL

Acoustic data

Tone type	Continuous tone, slow intermittent (1 Hz), rapid intermittent (2.5 Hz)
Sound pressure	80 dB
Number of tones	3 Piece(s)

Technical data

ECLASS 5.1.4	27371230
ECLASS 8.0	27371230
ECLASS 9.0	27371230
ECLASS 10.0	27371230
ECLASS 11.0	27371230
ECLASS 12.0	27371230
ECLASS 13.0	27371230
ECLASS 14.0	27371230
ECLASS 15.0	27371230
ETIM 5.0	EC001042
ETIM 6.0	EC001042
ETIM 7.0	EC001042
ETIM 8.0	EC001042
ETIM 9.0	EC001042
ETIM 10.0	EC001042

Dimensioned drawings

All dimensions in millimeters

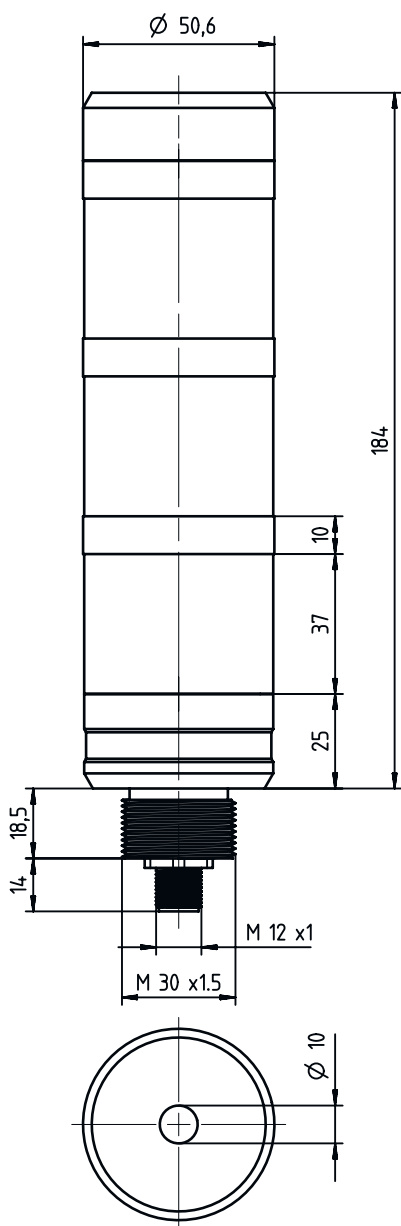

Electrical connection

Connection 1

Function	IO-Link Light color via control of pins (external trigger mode) Signal IN Voltage supply
Type of connection	Connector
Thread size	M12
Type	Male
Material	Metal
No. of pins	5 -pin
Encoding	A-coded

Electrical connection

Pin	Pin assignment	Conductor color
1	+	Brown
2	Trigger 1	White
3	-	Blue
4	Trigger 3 & IO-Link	Black
5	Trigger 2	Gray

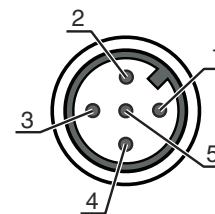

Diagrams



External Trigger Mode: Activation of the eight pre-sets via the three trigger inputs

Trigger Inputs			Pre-Sets	Factory Settings						
				TL305-3MC			TL305-3MC-BZ			
1	2	3		Seg. 1	Seg. 2	Seg. 3	Seg. 1	Seg. 2	Seg. 3	Buzzer
0	0	0	1	--	--	--	--	--	--	
1	0	0	2	--	--	Red	--	--	Red	
0	1	0	3	Green	--	--	Green	--	--	
1	1	0	4	--	Yellow	--	--	Yellow	--	
0	0	1	5	Blue	--	--	Blue	--	--	
1	0	1	6	White	--	--	White	--	--	
0	1	1	7	--	--	Red (slowly flashing)	--	--	Red (slowly flashing)	Buzzer (1 Hz)
1	1	1	8	--	--	Red (rapidly flashing)	--	--	Red (rapidly flashing)	Buzzer (2.5 Hz)



All trigger inputs have a delay of ~50 ms. Pre-sets can be defined via IO-Link.

Accessories

Connection technology - Connection unit

	Part no.	Designation	Article	Description
	50138211	MD 748i-11-82/L5-2222	IO-Link master	Type: IO-Link master Supply voltage: 20 ... 30 V Current consumption, max.: 12,000 mA Switching outputs for each sensor connection: 1 Piece(s) Interface: IO-Link, PROFINET Connections: 12 Piece(s) Sensor connections: 8 Piece(s) Connections for voltage supply: 2 Piece(s) Interface connections: 2 Piece(s) Degree of protection: IP 67
	50138212	MD 748iC-11-82/L5-2222 F001	IO-Link master	Type: IO-Link master Supply voltage: 20 ... 30 V Current consumption, max.: 12,000 mA Switching outputs for each sensor connection: 1 Piece(s) Interface: OPC UA, IO-Link, PROFINET Connections: 12 Piece(s) Sensor connections: 8 Piece(s) Connections for voltage supply: 2 Piece(s) Interface connections: 2 Piece(s) Degree of protection: IP 67

Accessories

	Part no.	Designation	Article	Description
	50144900	MD 798i-11-82/L5-2222	IO-Link master	Type: IO-Link master Current consumption, max.: 11,000 mA Switching outputs for each sensor connection: 1 Piece(s) Switching output: Transistor, PNP Interface: IO-Link, Automatic protocol detection, EtherNet IP, Modbus TCP, PROFINET Connections: 12 Piece(s) Sensor connections: 8 Piece(s) Connections for voltage supply: 2 Piece(s) Interface connections: 2 Piece(s) Degree of protection: IP 67, IP 65, IP 69K
	50121098	SET MD12-US2-IL1.1 + Zub.	Diagnostics set	Interface: USB Connections: 2 Piece(s) Degree of protection: IP 20



Connection technology - Connection cables

	Part no.	Designation	Article	Description
	50132079	KD U-M12-5A-V1-050	Connection cable	Connection 1: Connector, M12, Axial, Female, A-coded, 5 -pin Connector, LED: No Connection 2: Open end Shielded: No Cable length: 5.000 mm Sheathing material: PVC

Connection technology - Interconnection cables

	Part no.	Designation	Article	Description
	50133298	KDS U-M12-5A-M12-5A-V1-050	Interconnection cable	Connection 1: Connector, M12, Axial, Female, A-coded, 5 -pin Connection 2: Connector, M12, Axial, Male, A-coded, 5 -pin Shielded: No Cable length: 5,000 mm Sheathing material: PVC

Mounting

	Part no.	Designation	Article	Description
	50149110	TL305-AC.EP.100	Tower light element	Design: Cylindrical Diameter: 35 mm Version: Extension pipe Fastening, at system: Screw type
	50149111	TL305-AC.MB1	Tower light element	Design: L shape Version: Angle, L-shape Fastening, at system: Screw type

Accessories

	Part no.	Designation	Article	Description
	50149109	TL305-AC.MF.65	Tower light element	Design: Cylindrical Diameter: 98 mm Version: Mounting base Fastening, at system: Screw type

Note



A list with all available accessories can be found on the Leuze website in the Download tab of the article detailed page.