

Technical data sheet

Distance diffuse sensor with background suppression

Part no.: 50150021

ODT3CL1-2M.3/L6



For illustration purposes only

Contents

- Technical data
- Dimensioned drawings
- Electrical connection
- Diagrams
- Operation and display
- Part number code
- Notes
- Further information
- Accessories



CDRH



Technical data

Basic data

| | |
|---------------------|---|
| Series | 3C |
| Operating principle | Distance diffuse sensor with background suppression |

Special version

| | |
|-----------------|---|
| Special version | 2 independent switching outputs Measurement value output |
|-----------------|---|

Optical data

| | |
|-----------------------------|--|
| Black-white error | ±20 mm |
| Operating range | 0.07 ... 2 m |
| Operating range | Guaranteed operating range |
| Adjustment range | 50 ... 2,500 mm |
| Beam path | Focused |
| Light source | Laser, Red |
| Wavelength | 680 nm |
| Laser class | 1, IEC 60825-1:2014 / EN 60825-1:2014+A11:2021 |
| Transmitted-signal shape | Pulsed |
| Type of light spot geometry | Round |
| Shift angle | Typ. ± 1.5° |

Measurement data

| | |
|--|-----------------|
| Measurement range | 50 ... 2,500 mm |
| Resolution | 1.0 mm |
| Accuracy | -20 ... 20 mm |
| Reproducibility (1 sigma) | 0 ... 8 mm |
| Measurement value output | via IO-Link |
| Optical distance measurement principle | Time of flight |

Electrical data

| | |
|--------------------|------------------------------|
| Protective circuit | Polarity reversal protection |
| | Short circuit protected |
| | Transient protection |

Performance data

| | |
|----------------------|--|
| Supply voltage U_B | 10 ... 30 V, DC, Incl. residual ripple |
| Residual ripple | 0 ... 15 %, From U_B |
| Open-circuit current | 0 ... 35 mA |

Outputs

| | |
|-------------------------------------|------------|
| Number of digital switching outputs | 2 Piece(s) |
|-------------------------------------|------------|

Switching outputs

| | |
|-------------------------|---|
| Voltage type | DC |
| Switching current, max. | 90 mA |
| Switching voltage | high: $\geq(U_B - 2V)$ low: $\leq 2 V$ |

Switching output 1

| | |
|---------------------|--|
| Assignment | Connection 1, pin 4 |
| Switching element | Transistor, Push-pull |
| Switching principle | IO-Link / light switching (PNP)/dark switching (NPN) |

Switching output 2

| | |
|---------------------|--|
| Assignment | Connection 1, pin 2 |
| Switching element | Transistor, Push-pull |
| Switching principle | Light switching (PNP)/dark switching (NPN) |

Time behavior

| | |
|---------------------|--|
| Switching frequency | 7 ... 15 Hz, depending on diffuse reflectance |
| Response time | 33 ... 70 ms, depending on diffuse reflectance |
| Readiness delay | 300 ms |

Interface

| | |
|------------------|----------------------|
| Type | IO-Link |
| IO-Link | |
| COM mode | COM3 |
| Profile | Smart sensor profile |
| Min. cycle time | COM3 = 0.6 ms |
| Frame type | 2.V |
| Specification | V1.1 |
| Device ID | 2220 |
| SIO-mode support | Yes |

Connection

Connection 1

| | |
|----------------------|---------------------|
| Function | Signal IN |
| | Signal OUT |
| | Voltage supply |
| Type of connection | Cable |
| Cable length | 2,000 mm |
| Sheathing material | PUR |
| Cable color | Black |
| Number of conductors | 4 -wire |
| Wire cross section | 0.2 mm ² |

Mechanical data

| | |
|----------------------------|---|
| Dimension (W x H x L) | 11.4 mm x 34.2 mm x 18.3 mm |
| Housing material | Plastic |
| Plastic housing | PC-ABS |
| Lens cover material | Plastic / PMMA |
| Net weight | 50 g |
| Housing color | Red |
| Type of fastening | Through-hole mounting Via optional mounting device |
| Compatibility of materials | ECOLAB |

Operation and display

| | |
|-------------------------------------|--|
| Type of display | LED |
| Number of LEDs | 2 Piece(s) |
| Operational controls | Teach button |
| Function of the operational control | Light/dark switching Range adjustment |

Environmental data

| | |
|--------------------------------|---------------|
| Ambient temperature, operation | -30 ... 50 °C |
| Ambient temperature, storage | -40 ... 70 °C |

Certifications

| | |
|----------------------|-----------------|
| Degree of protection | IP 67 IP 69K |
| Protection class | III |
| Approvals | c UL US |
| Standards applied | IEC 60947-5-2 |

Technical data

| | |
|-----------------------|----------|
| Customs tariff number | 85365019 |
| ECLASS 5.1.4 | 27270904 |
| ECLASS 8.0 | 27270904 |
| ECLASS 9.0 | 27270904 |
| ECLASS 10.0 | 27270904 |
| ECLASS 11.0 | 27270904 |
| ECLASS 12.0 | 27270903 |
| ECLASS 13.0 | 27270903 |
| ECLASS 14.0 | 27270903 |
| ECLASS 15.0 | 27270903 |
| ETIM 5.0 | EC002719 |
| ETIM 6.0 | EC002719 |
| ETIM 7.0 | EC002719 |
| ETIM 8.0 | EC002719 |
| ETIM 9.0 | EC002719 |
| ETIM 10.0 | EC002719 |

Dimensioned drawings

All dimensions in millimeters

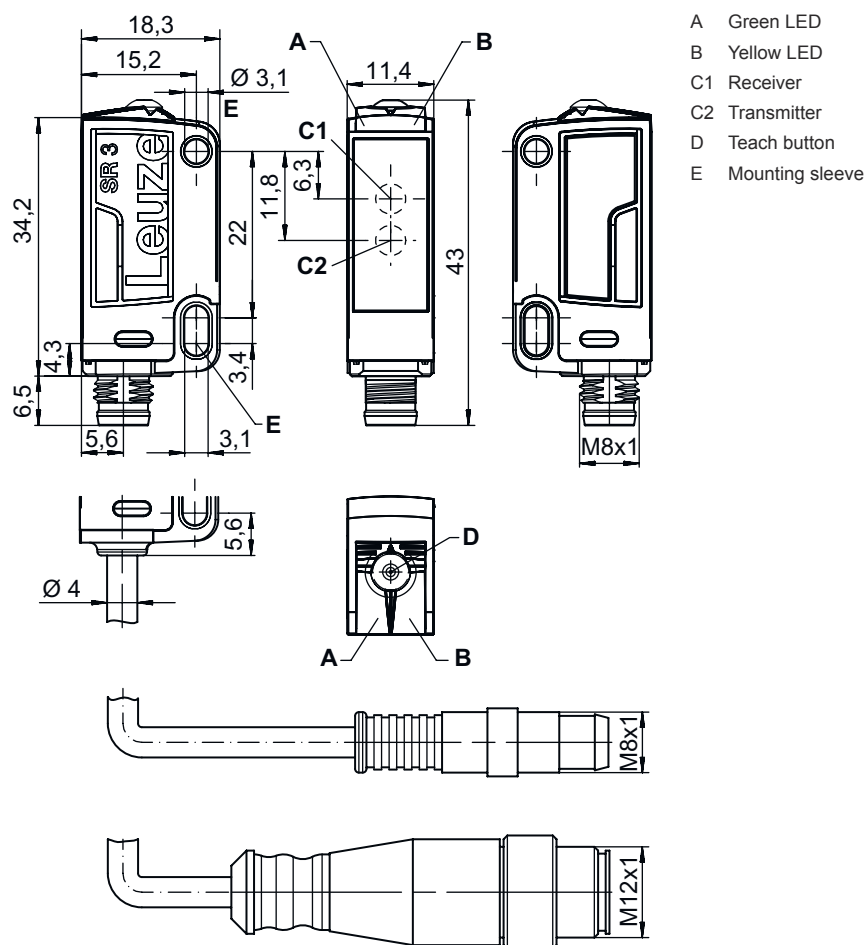

Electrical connection

Connection 1

| | |
|----------------------|---------------------|
| Function | Signal IN |
| | Signal OUT |
| | Voltage supply |
| Type of connection | Cable |
| Cable length | 2,000 mm |
| Sheathing material | PUR |
| Cable color | Black |
| Number of conductors | 4 -wire |
| Wire cross section | 0.2 mm ² |

Conductor color

Brown
White
Blue
Black

Conductor assignment

V+
OUT 2
GND
IO-Link / OUT 1

Diagrams

Typ. response behavior (white 90 %)

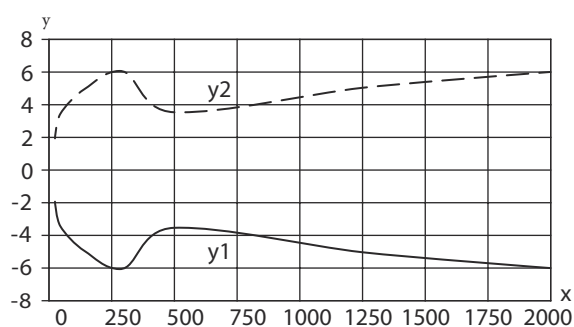

x Distance [mm]
y Misalignment [mm]

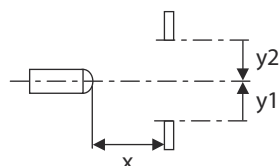

Diagrams

Typ. black/white behavior / measurement accuracy

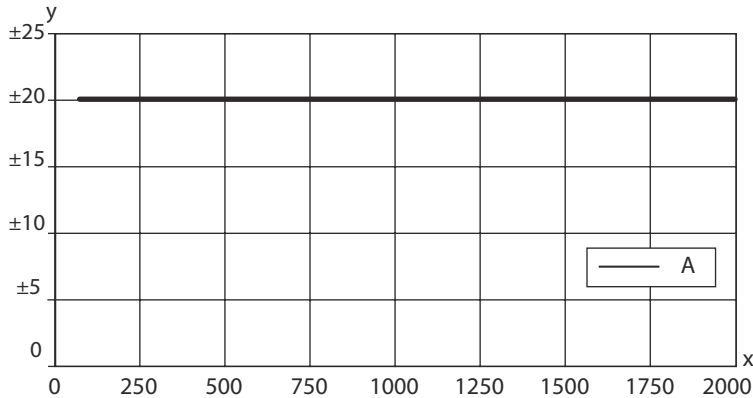

x Range [mm]
 y Typ. range change [mm], reference: white 90%
 A 6 ... 90% diffuse reflectance

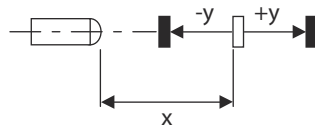

Operation and display

| LED | Display | Meaning |
|-----|--------------------------|-----------------|
| 1 | Green, continuous light | Ready |
| 2 | Yellow, continuous light | Object detected |

Part number code

Part designation: **AAA 3C d EE-f.GG H/i J-K**

| | |
|--------------|--|
| AAA3C | <p>Operating principle / construction HT3C: Diffuse reflection sensor with background suppression LS3C: Throughbeam photoelectric sensor transmitter LE3C: Throughbeam photoelectric sensor receiver PRK3C: Retro-reflective photoelectric sensor with polarization filter ODT3C: Distance diffuse sensor with background suppression</p> |
| d | <p>Light type n/a: red light I: infrared light</p> |
| EE | <p>Light source n/a: LED L1: laser class 1 L2: laser class 2 PP: Power PinPoint LED</p> |
| f | <p>Preset range (optional) n/a: operating range acc. to data sheet xxxF: Preset range [mm] 2M: operating range of 2 meters</p> |
| GG | <p>Equipment n/a: standard A: Autocollimation principle (single lens) for positioning tasks B: Housing model with two M3 threaded sleeves, brass F: Permanently set range L: Long light spot S: small light spot T: autocollimation principle (single lens) for highly transparent bottles without tracking TT: autocollimation principle (single lens) for highly transparent bottles with tracking V: V-optics XL: Extra long light spot X: extended model HF: Suppression of HF illumination (LED)</p> |

Part number code

| | |
|----------|--|
| H | Operating range adjustment n/a with HT: range adjustable via 8-turn potentiometer n/a with retro-reflective photoelectric sensors (PRK): operating range not adjustable 1: 270° potentiometer 3: teach-in via button 6: auto-teach |
| i | Switching output/function OUT 1/IN: Pin 4 or black conductor 2: NPN transistor output, light switching N: NPN transistor output, dark switching 4: PNP transistor output, light switching P: PNP transistor output, dark switching 6: push-pull switching output, PNP light switching, NPN dark switching G: Push-pull switching output, PNP dark switching, NPN light switching L: IO-Link interface (SIO mode: PNP light switching, NPN dark switching) 8: activation input (activation with high signal) X: pin not used 1: IO-Link / light switching (NPN) / dark switching (PNP) |
| J | Switching output / function OUT 2/IN: pin 2 or white conductor 2: NPN transistor output, light switching N: NPN transistor output, dark switching 4: PNP transistor output, light switching P: PNP transistor output, dark switching 6: push-pull switching output, PNP light switching, NPN dark switching G: Push-pull switching output, PNP dark switching, NPN light switching W: warning output X: pin not used 8: activation input (activation with high signal) 9: deactivation input (deactivation with high signal) T: teach-in via cable |
| K | Electrical connection n/a: cable, standard length 2000 mm, 4-wire 5000: cable, standard length 5000 mm, 4-wire M8: M8 connector, 4-pin (plug) M8.3: M8 connector, 3-pin (plug) 200-M8: cable, length 200 mm with M8 connector, 4-pin, axial (plug) 200-M8.3: cable, length 200 mm with M8 connector, 3-pin, axial (plug) 200-M12: cable, length 200 mm with M12 connector, 4-pin, axial (plug) |

Note



A list with all available device types can be found on the Leuze website at www.leuze.com.

Notes



Observe intended use!



- ⌘ This product is not a safety sensor and is not intended as personnel protection.
- ⌘ The product may only be put into operation by competent persons.
- ⌘ Only use the product in accordance with its intended use.

For UL applications:



- ⌘ For UL applications, use is only permitted in Class 2 circuits in accordance with the NEC (National Electric Code).
- ⌘ These proximity switches shall be used with UL Listed Cable assemblies rated 30V, 0.5A min, in the field installation, or equivalent (categories: CYJV/ CYJV7 or PVVA/PVVA7)

Notes

ATTENTION! LASER RADIATION – CLASS 1 LASER PRODUCT



The device satisfies the requirements of IEC 60825-1:2014 / EN 60825-1:2014+A11:2021 safety regulations for a product of **laser class 1** and complies with 21 CFR 1040.10 except for conformance with IEC 60825-1 Ed. 3., as described in Laser Notice No. 56, dated May 8, 2019.

- ↳ Observe the applicable statutory and local laser protection regulations.
- ↳ The device must not be tampered with and must not be changed in any way.
 - There are no user-serviceable parts inside the device.
 - There are no user-serviceable parts inside the device.
 - Repairs must only be performed by Leuze electronic GmbH + Co. KG.

Further information

- Sum of the output currents for both outputs, 50 mA for ambient temperatures > 40 °C
- With a supply voltage >18 V and an ambient temperature <40 °C, the maximum switching current is 100 mA per switching output.
- When starting the sensor below -20°C, a warmup time of one minute is required until the first teach-in

Accessories

Mounting technology - Mounting brackets

| | Part no. | Designation | Article | Description |
|---|----------|-------------|-----------------|--|
|  | 50060511 | BT 3 | Mounting device | Design of mounting device: Angle, L-shape Fastening, at system: Through-hole mounting Mounting bracket, at device: Screw type Type of mounting device: Rigid Material: Metal |

Mounting technology - Rod mounts

| | Part no. | Designation | Article | Description |
|---|----------|--------------|-----------------|--|
|  | 50117255 | BTU 200M-D12 | Mounting system | Design of mounting device: Mounting system Fastening, at system: For 12 mm rod, Sheet-metal mounting Mounting bracket, at device: Screw type, Suited for M3 screws Type of mounting device: Clampable, Adjustable, Turning, 360° Material: Metal |

Note



- ↳ A list with all available accessories can be found on the Leuze website in the Download tab of the article detailed page.