

## Technical data sheet

### Tower light

Part no.: 50143951

A7-V1-MP1-DS-M7-T-100-M12

#### Contents

- Technical data
- Dimensioned drawings
- Electrical connection
- Notes
- Accessories



For illustration purposes only



## Technical data

### Basic data

Series	A7
Type of signaling	Optical

### Electrical data

Life expectancy	> 100,000 h
-----------------	-------------

#### Performance data

Supply voltage $U_B$	24 V, DC, 10 %
Current consumption, max.	70 mA

### Connection

Number of connections	1 Piece(s)
-----------------------	------------

Notes	Protected against accidental interchanges: Actuation of the colors is performed via PINs, thus, the calotte position can be freely selected (see operating instructions). The individual colors are actuated via VCC (PNP)
-------	---

#### Connection 1

Function	Light color programmable via actuation of wires Voltage supply
Type of connection	Connector
Thread size	M12
Type	Male
Material	Metal
No. of pins	8 -pin
Encoding	A-coded

### Mechanical data

Design	Cylindrical
Dimension ( $\varnothing$ x L)	70 mm x 220 mm
Housing material	Plastic
Plastic housing	PC
Net weight	333 g
Housing color	Black Gray
Type of fastening, at system	Screw type / horizontal
Type of illuminant	LED/24V
Lens modules	1 piece
Signal image	Continuous or flashing light
Angle of radiation	360°

### Environmental data

Ambient temperature, operation	-10 ... 60 °C
--------------------------------	---------------

### Certifications

Degree of protection	IP 66
Approvals	CE CSA

### Classification

Customs tariff number	85318070
ECLASS 5.1.4	27371230
ECLASS 8.0	27371230
ECLASS 9.0	27371220
ECLASS 10.0	27371230
ECLASS 11.0	27371230
ECLASS 12.0	27371230
ECLASS 13.0	27371230
ECLASS 14.0	27371230
ECLASS 15.0	27371230
ETIM 5.0	EC001042
ETIM 6.0	EC001042
ETIM 7.0	EC001042
ETIM 8.0	EC001042
ETIM 9.0	EC001042
ETIM 10.0	EC001042

# Dimensioned drawings

All dimensions in millimeters

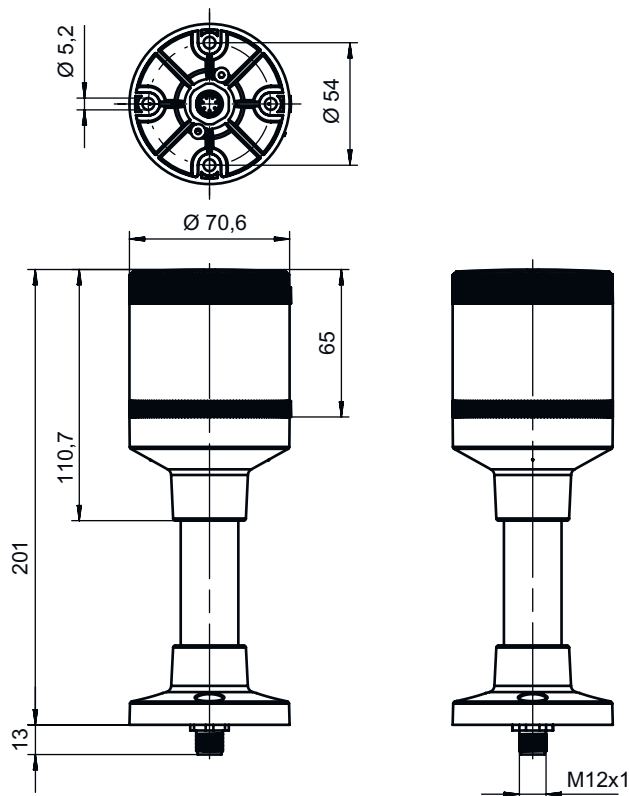

## Electrical connection

### Connection 1

<b>Function</b>	Light color programmable via actuation of wires Voltage supply
<b>Type of connection</b>	Connector
<b>Thread size</b>	M12
<b>Type</b>	Male
<b>Material</b>	Metal
<b>No. of pins</b>	8 -pin
<b>Encoding</b>	A-coded

### Conductor color

### Conductor assignment

<b>White</b>	VCC / Light color: white
<b>Brown</b>	n.c.
<b>Green</b>	VCC / Light color: green
<b>Yellow</b>	VCC / Light color: yellow/orange
<b>Gray</b>	GND
<b>Pink</b>	n.c.
<b>Blue</b>	VCC / Light color: blue
<b>Red</b>	VCC / Light color: red

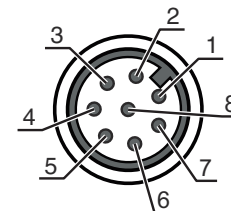

## Electrical connection



Conductor color	Conductor assignment
Blue / Red	VCC / Multicolor light color: pink
Green / Red	VCC / Multicolor light color: yellow
Blue / Green	VCC / Multicolor light color: turquoise
Blue / Green / Red	VCC / Multicolor light color: white
NOTE	Connect all listed wires to obtain the corresponding light color.

## Notes

⚠ Observe intended use!	
	⚡ This product is not a safety sensor and is not intended as personnel protection.
	⚡ The product may only be put into operation by competent persons.
	⚡ Only use the product in accordance with its intended use.

## Accessories

### Connection technology - Connection cables

	Part no.	Designation	Article	Description
	50135127	KD S-M12-8A-P1-020	Connection cable	Connection 1: Connector, M12, Axial, Female, A-coded, 8 -pin Connector, LED: No Connection 2: Open end Shielded: Yes Cable length: 2.000 mm Sheathing material: PUR
	50135128	KD S-M12-8A-P1-050	Connection cable	Connection 1: Connector, M12, Axial, Female, A-coded, 8 -pin Connector, LED: No Connection 2: Open end Shielded: Yes Cable length: 5.000 mm Sheathing material: PUR
	50135133	KD S-M12-8W-P1-050	Connection cable	Connection 1: Connector, M12, Angled, Female, A-coded, 8 -pin Connector, LED: No Connection 2: Open end Shielded: Yes Cable length: 5.000 mm Sheathing material: PUR



### Muting - Mounting systems

	Part no.	Designation	Article	Description
	50142896	A7-MW2	Tower light element	Design: L shape Version: Angle, L-shape Fastening, at system: Through-hole mounting

## Accessories

	Part no.	Designation	Article	Description
	50143660	A7-MW2.5	Tower light element	Design: L shape Version: Angle, L-shape Fastening, at system: Through-hole mounting

## General

	Part no.	Designation	Article	Description
	50135462	A7-V1-BZ1-M	Tower light element	Signaling: Acoustic Current consumption, max.: 70 mA Design: Cylindrical Diameter: 70 mm Fastening: Bayonet system Operational controls: DIP switch, 225° potentiometer Ambient temperature: -10 ... 60 °C Degree of protection: IP 66 Tone type: Continuous or pulse tone Sound pressure: 100 dB Number of tones: 8 Piece(s)
	50138151	A7-V1-BZ2-S	Tower light element	Signaling: Acoustic Current consumption, max.: 30 mA Design: Cylindrical Diameter: 70 mm Fastening: Bayonet system Operational controls: 225° potentiometer Ambient temperature: -10 ... 60 °C Degree of protection: IP 66 Tone type: Continuous tone Sound pressure: 105 dB Number of tones: 1 Piece(s)
	50138366	A7-V1-BZ3-S	Tower light element	Signaling: Acoustic Current consumption, max.: 30 mA Design: Cylindrical Diameter: 70 mm Fastening: Bayonet system Operational controls: 225° potentiometer Ambient temperature: -10 ... 60 °C Degree of protection: IP 66 Tone type: Pulse tone Sound pressure: 105 dB Number of tones: 1 Piece(s)

### Note



A list with all available accessories can be found on the Leuze website in the Download tab of the article detailed page.