

Technical data sheet

Muting indicator

Part no.: 50135453

M4-V1-MW3-DS-C-T-M12-200

Contents

- Technical data
- Dimensioned drawings
- Electrical connection
- Notes



For illustration purposes only



Technical data

Basic data

Series	M4
Type of signaling	Optical

Optical data

Light source	White
--------------	-------

Electrical data

Life expectancy	> 100,000 h
-----------------	-------------

Performance data

Supply voltage U _B	24 V, AC/DC, 10 %
Current consumption, max.	27 mA

Connection

Number of connections	1 Piece(s)
-----------------------	------------

Connection 1

Function	Voltage supply
Type of connection	Cable with connector
Cable length	2,000 mm
Thread size	M12
Type	Male
Material	Metal
No. of pins	5 -pin
Encoding	A-coded

Mechanical data

Design	Cylindrical
Dimension (Ø x L)	40 mm x 200 mm
Housing material	Plastic
Plastic housing	PC
Housing color	Black Clear
Type of illuminant	LED/24V
Signal image	Continuous light
Lens color	Clear
Angle of radiation	360°

Environmental data

Ambient temperature, operation	-30 ... 60 °C
--------------------------------	---------------

Certifications

Degree of protection	IP 66
Approvals	c UL US CE

Classification

Customs tariff number	85318070
ECLASS 5.1.4	27371230
ECLASS 8.0	27371230
ECLASS 9.0	27371220
ECLASS 10.0	27371230
ECLASS 11.0	27371230
ECLASS 12.0	27371230
ECLASS 13.0	27371230
ECLASS 14.0	27371230
ECLASS 15.0	27371230
ETIM 5.0	EC001042
ETIM 6.0	EC001042
ETIM 7.0	EC001042
ETIM 8.0	EC001042
ETIM 9.0	EC001042
ETIM 10.0	EC001042

Dimensioned drawings

All dimensions in millimeters

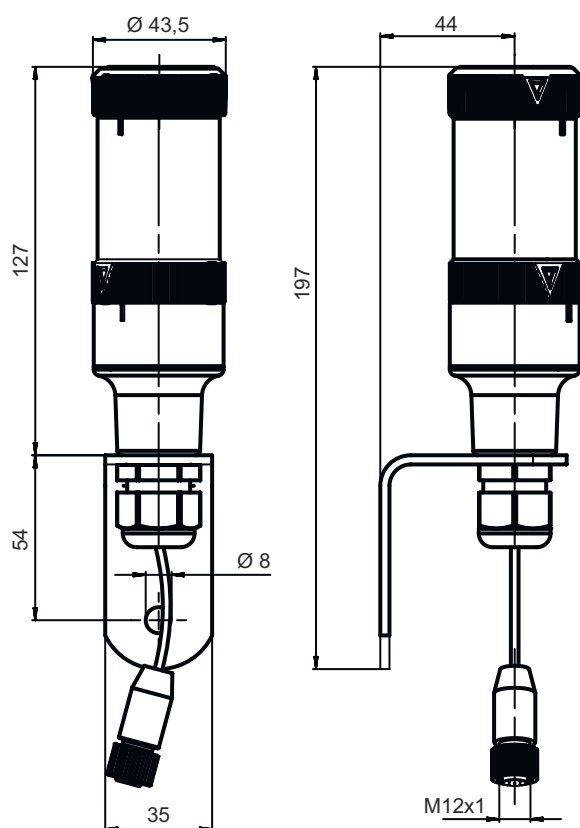

Electrical connection

Connection 1

Function	Voltage supply
Type of connection	Cable with connector
Cable length	2,000 mm
Cable color	Black
Thread size	M12
Type	Male
Material	Metal
No. of pins	5 -pin
Encoding	A-coded

Notes



Observe intended use!



- ⚠ This product is not a safety sensor and is not intended as personnel protection.
- ⚠ The product may only be put into operation by competent persons.
- ⚠ Only use the product in accordance with its intended use.