

## Technical data sheet

### Color sensor

Part no.: 50152608

CRT648-150/LT-M12

#### Contents

- Technical data
- Dimensioned drawings
- Electrical connection
- Accessories



For illustration purposes only

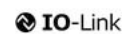

## Technical data

### Basic data

Series	648
Application	Detection of one color

### Special version

Special version	Teach input (configurable sync / key lock)
-----------------	--

### Optical data

Operating range	20 ... 150 mm
Beam path	Divergent
Light source	LED, White
LED risk group	Group 2 (in accordance with EN62471)
Light spot size [at sensor distance]	8 mm x 8 mm [60 mm]
Type of light spot geometry	Rectangular

### Electrical data

Protective circuit	Polarity reversal protection Short circuit protected
Output current, max.	100 mA

#### Performance data

Supply voltage $U_B$	18 ... 30 V, DC
Open-circuit current, max.	60 mA, 24 V DC

#### Inputs

Number of teach inputs	1 Piece(s)
------------------------	------------

#### Teach inputs

Type	Teach input
------	-------------

#### Teach input 1

Function	Teach-in
----------	----------

#### Outputs

Number of digital switching outputs	1 Piece(s)
-------------------------------------	------------

#### Switching outputs

Type	Digital switching output
------	--------------------------

#### Switching output 1

Switching element	Transistor, Push-pull
Switching principle	IO-Link / light switching (PNP)/dark switching (NPN)

### Time behavior

Switching frequency	3 ... 3,000 Hz
Response time	≤ 180 ms, ≥ 1500 Hz
Warmup time	5 min

### Interface

Type	IO-Link
------	---------

#### IO-Link

COM mode	COM2
Min. cycle time	COM2 = 4 ms
Specification	V1.1
Device ID	5301
SIO-mode support	Yes
Process data, length	3 byte

### Connection

Number of connections	1 Piece(s)
-----------------------	------------

#### Connection 1

Function	Signal IN Signal OUT Voltage supply
Type of connection	Connector, turning 270°
Thread size	M12
Type	Male
Material	Metal
No. of pins	4 -pin
Encoding	A-coded

### Mechanical data

Design	Cubic
Dimension (W x H x L)	25 mm x 50 mm x 50.5 mm
Housing material	Metal
Metal housing	Diecast zinc
Lens cover material	Plastic / PMMA
Net weight	150 g
Housing color	matte chrome
Type of fastening	Through-hole mounting Via optional mounting device
Compatibility of materials	ECOLAB

### Operation and display

Type of display	LC Display LED
Operational controls	Control buttons

### Environmental data

Ambient temperature, operation	-20 ... 55 °C
Ambient temperature, storage	-20 ... 80 °C

### Certifications

Degree of protection	IP 67 IP 69
Protection class	II
Approvals	c UL US
Test procedure for oscillation in accordance with standard	EN 60947-5-2
Test procedure for shock in accordance with standard	EN 60947-5-2
Standards applied	EN IEC 60947-5-2

## Technical data

Customs tariff number	85365019
ECLASS 5.1.4	27270907
ECLASS 8.0	27270907
ECLASS 9.0	27270907
ECLASS 10.0	27270907
ECLASS 11.0	27270907
ECLASS 12.0	27270907
ECLASS 13.0	27270907
ECLASS 14.0	27270907
ECLASS 15.0	27270907
ETIM 5.0	EC001817
ETIM 6.0	EC001817
ETIM 7.0	EC001817
ETIM 8.0	EC001817
ETIM 9.0	EC001817
ETIM 10.0	EC001817

## Dimensioned drawings

All dimensions in millimeters

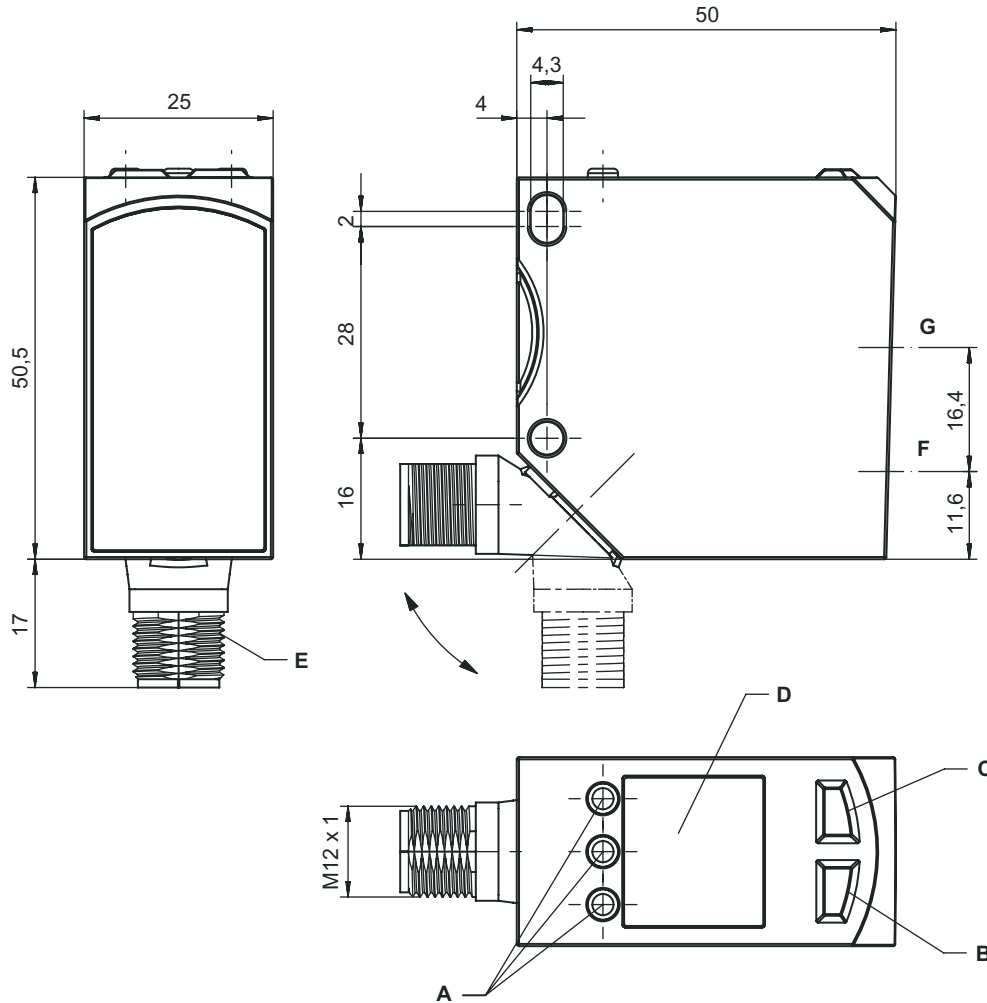

- A Control buttons
- B LED(2)
- C LED(1)
- D Display
- E M12 x 1
- F Transmitter
- G Receiver

## Electrical connection

### Connection 1

Function	Signal IN
	Signal OUT
	Voltage supply
Type of connection	Connector, turning 270°
Thread size	M12
Type	Male
Material	Metal
No. of pins	4 -pin
Encoding	A-coded

## Electrical connection

Pin	Pin assignment	Conductor color
1	V+	Brown
2	IN1	White
3	V-	Blue
4	IO-Link / OUT 1	Black

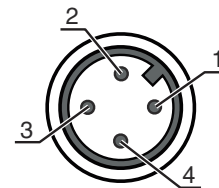





## Accessories

### Connection technology - Connection unit

	Part no.	Designation	Article	Description
	50144900	MD 798i-11-82/L5-2222	IO-Link master	Type: IO-Link master Current consumption, max.: 11,000 mA Switching outputs for each sensor connection: 1 Piece(s) Switching output: Transistor, PNP Interface: IO-Link, Automatic protocol detection, EtherNet IP, Modbus TCP, PROFINET Connections: 12 Piece(s) Sensor connections: 8 Piece(s) Connections for voltage supply: 2 Piece(s) Interface connections: 2 Piece(s) Degree of protection: IP 67, IP 65, IP 69K

### Connection technology - Connection cables

	Part no.	Designation	Article	Description
	50133855	KD S-M12-5A-V1-020	Connection cable	Connection 1: Connector, M12, Axial, Female, A-coded, 5 -pin Connector, LED: No Connection 2: Open end Shielded: Yes Cable length: 2.000 mm Sheathing material: PVC
	50133856	KD S-M12-5A-V1-050	Connection cable	Connection 1: Connector, M12, Axial, Female, A-coded, 5 -pin Connector, LED: No Connection 2: Open end Shielded: Yes Cable length: 5.000 mm Sheathing material: PVC
	50132077	KD U-M12-5A-V1-020	Connection cable	Connection 1: Connector, M12, Axial, Female, A-coded, 5 -pin Connector, LED: No Connection 2: Open end Shielded: No Cable length: 2.000 mm Sheathing material: PVC
	50132079	KD U-M12-5A-V1-050	Connection cable	Connection 1: Connector, M12, Axial, Female, A-coded, 5 -pin Connector, LED: No Connection 2: Open end Shielded: No Cable length: 5.000 mm Sheathing material: PVC

## Accessories

### Mounting technology - Rod mounts

	Part no.	Designation	Article	Description
	50117252	BTU 300M-D12	Mounting system	Design of mounting device: Mounting system Fastening, at system: For 12 mm rod, Sheet-metal mounting Mounting bracket, at device: Screw type, Suited for M4 screws Type of mounting device: Clampable, Adjustable, Turning, 360° Material: Metal

### Configuration devices

	Part no.	Designation	Article	Description
	50124709	PA1/XTSX-M12	Programming unit	Functions: Teach-in activation Connection: Connector, M12, 5 -pin

#### Note



A list with all available accessories can be found on the Leuze website in the Download tab of the article detailed page.