

Technical data sheet Optical distance sensor

Part no.: 50129531

ODS10L1.8/LAK



For illustration purposes only

Contents

- Technical data
- Dimensioned drawings
- Electrical connection
- Diagrams
- Operation and display
- Part number code
- Notes
- Accessories



CDRH  IO-Link

Technical data

Basic data

Series	10
Application	Collision protection for transport vehicles Fill-level monitoring
Type of scanning system	Against object

Special version

Special version	Activation input Deactivation input Teach input
-----------------	---

Characteristic parameters

MTTF	29 years
------	----------

Optical data

Beam path	Collimated
Light source	Laser, Red
Wavelength	658 nm
Laser class	1, IEC/EN 60825-1:2014
Transmitted-signal shape	Pulsed
Light spot size [at sensor distance]	7 mm x 7 mm [8,000 mm]
Type of light spot geometry	Rectangular

Measurement data

Measurement range	50 ... 3,500 mm, at 6 ... 90% diffuse reflection
Measurement range (90 % diffuse reflection)	50 ... 8,000 mm
Resolution	1.0 mm
Accuracy	15 mm
Measurement time, measure mode	"High precision": response time = 1000 ms/output time = 3.4 ms Fast: response time = 15 ms/output time = 3.4 ms Individual measure modes, see diagram Individual: response time = 3.4 ... 1020 ms/output time = 3.4 ms Outlier suppression: response time = 17 ... 1020 ms/output time = 17 ... 1020 ms Precision: response time = 200 ms/output time = 3.4 ms Standard: response time = 50 ms/output time = 3.4 ms
Reproducibility (1 sigma)	4 mm
Temperature drift	2 mm/K
Referencing	No
Black/white behavior	10 mm
Standard measurement object	50 x 50 mm ²
Optical distance measurement principle	Time of flight

Electrical data

Protective circuit	Polarity reversal protection Short circuit protected Transient protection
--------------------	---

Performance data

Supply voltage U_B	18 ... 30 V, DC
Residual ripple	0 ... 15 %, From U_B
Open-circuit current	0 ... 150 mA

Inputs

Number of digital switching inputs	1 Piece(s)
------------------------------------	------------

Switching inputs

Voltage type	DC
Switching voltage	U_B

Digital switching input 1

Assignment	Connection 1, conductor 5
Function	Activation input Deactivation input Teach input

Outputs

Number of analog outputs	1 Piece(s)
--------------------------	------------

Number of digital switching outputs	1 Piece(s)
-------------------------------------	------------

Analog outputs

Analog output 1

Type	Configurable, factory setting: current
Assignment	Connection 1, conductor 2

Switching outputs

Voltage type	DC
Switching voltage	high: $\geq(U_B-2V)$ low: $\leq 2 V$

Switching output 1

Assignment	Connection 1, conductor 4
Switching element	Transistor, Push-pull
Switching principle	IO-Link / light switching (PNP)/dark switching (NPN)
Function	Independently adjustable switching outputs

Time behavior

Readiness delay	300 ms
-----------------	--------

Interface

Type	IO-Link
------	---------

IO-Link

COM mode	COM2
Min. cycle time	COM2 = 2.3 ms
Frame type	2.V
Port type	A
Specification	V1.1
SIO-mode support	Yes
Process data IN	3 byte
Process data OUT	0 byte
Dual Channel	Yes

Connection

Number of connections	1 Piece(s)
-----------------------	------------

Technical data

Connection 1

Function	Signal IN
	Signal OUT
	Voltage supply
Type of connection	Cable
Cable length	2,000 mm
Sheathing material	PUR
Cable color	Black
Number of conductors	5 -wire
Wire cross section	0.14 mm ²

Mechanical data

Design	Cubic
Dimension (W x H x L)	25 mm x 65 mm x 55 mm
Housing material	Plastic
Lens cover material	Glass
Net weight	133 g
Housing color	Red
Type of fastening	Through-hole mounting
	Via optional mounting device

Operation and display

Type of display	LED
	OLED display
Number of LEDs	5 Piece(s)
Operational controls	Control buttons
	PC software

Environmental data

Ambient temperature, operation	-40 ... 50 °C
Ambient temperature, storage	-40 ... 70 °C

Certifications

Degree of protection	IP 67
Protection class	III
Approvals	c UL US

Classification

Customs tariff number	90318020
ECLASS 5.1.4	27270801
ECLASS 8.0	27270801
ECLASS 9.0	27270801
ECLASS 10.0	27270801
ECLASS 11.0	27270801
ECLASS 12.0	27270916
ECLASS 13.0	27270916
ECLASS 14.0	27270916
ECLASS 15.0	27270916
ETIM 5.0	EC001825
ETIM 6.0	EC001825
ETIM 7.0	EC001825
ETIM 8.0	EC001825
ETIM 9.0	EC001825
ETIM 10.0	EC001825

Dimensioned drawings

All dimensions in millimeters

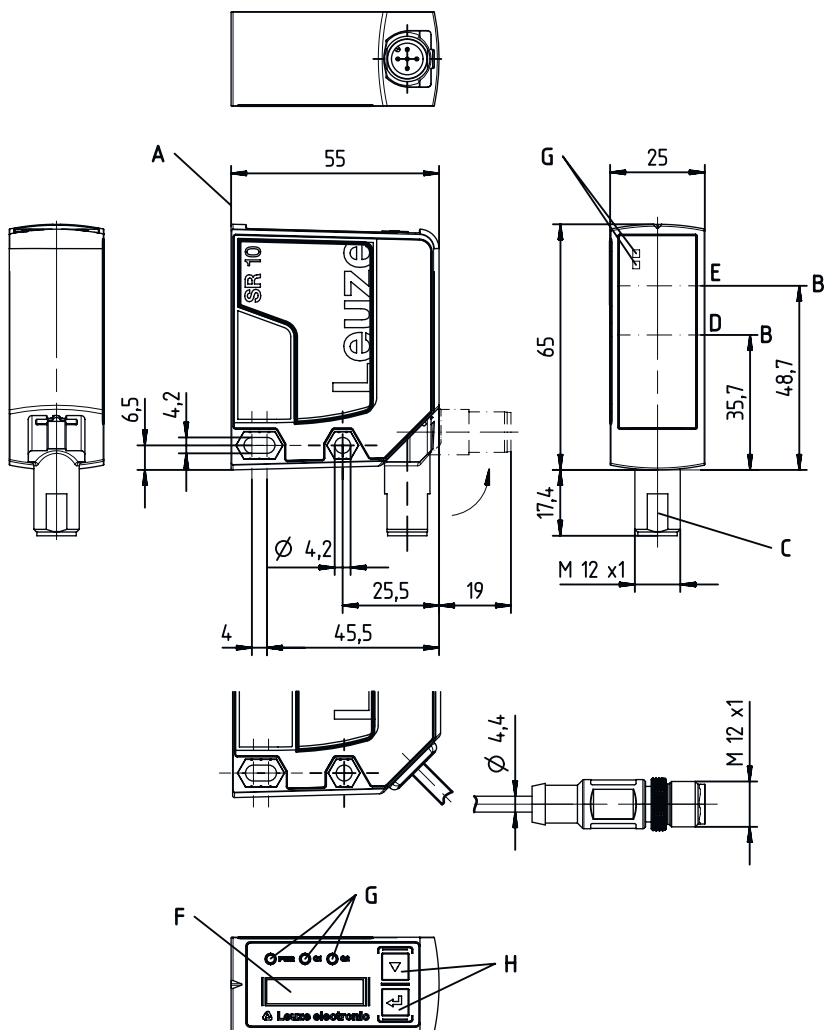

Electrical connection

Connection 1

Function	Signal IN Signal OUT Voltage supply
Type of connection	Cable
Cable length	2,000 mm
Sheathing material	PUR
Cable color	Black
Number of conductors	5 -wire
Wire cross section	0.14 mm ²

Conductor color

Conductor assignment

Brown	18 ... 30 V DC +
White	OUT mA / V
Blue	GND
Black	IO-Link / OUT 1
Gray	IN 1

Diagrams

Typical reproducibility: "Fast" measure mode

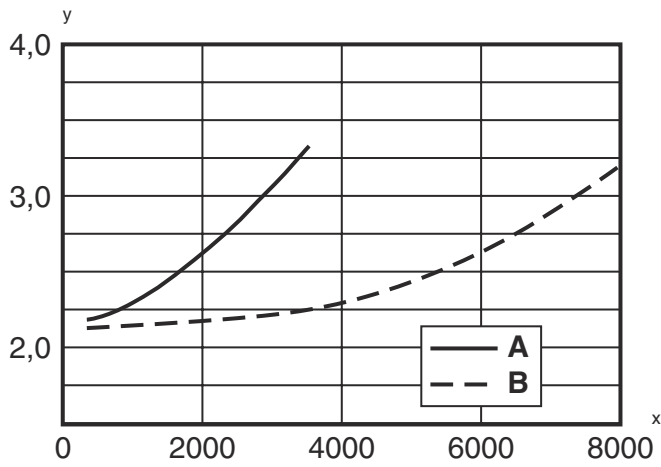

x Distance [mm]
 y Reproducibility [mm]
 A At 6% diffuse reflection
 B At 90% diffuse reflection

Typical reproducibility: "Standard" measure mode

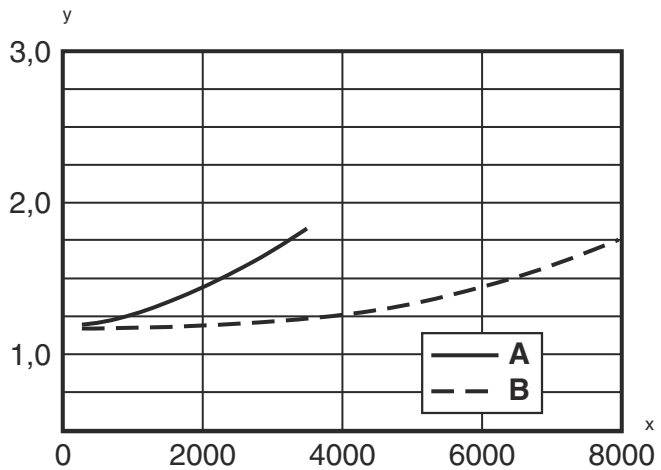

x Distance [mm]
 y Reproducibility [mm]
 A At 6% diffuse reflection
 B At 90% diffuse reflection

Typical reproducibility: "Precision" measure mode

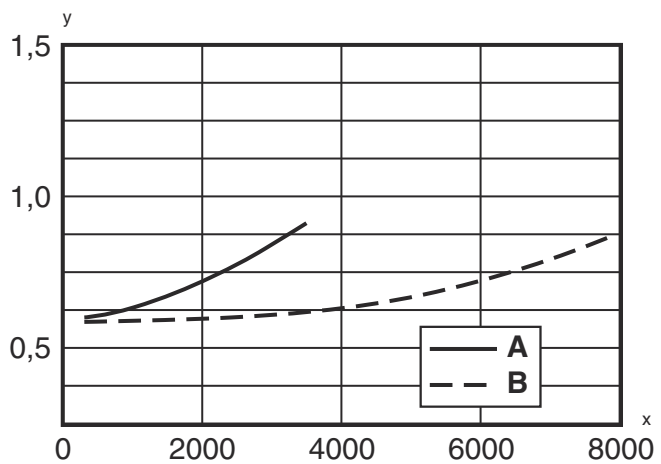

x Distance [mm]
 y Reproducibility [mm]
 A At 6% diffuse reflection
 B At 90% diffuse reflection

Diagrams

Typical reproducibility: "High precision" measure mode

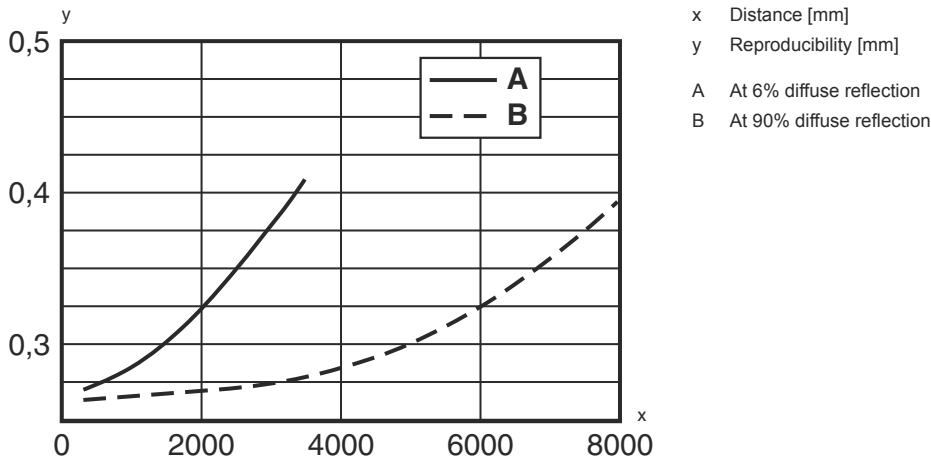

Operation and display

LED	Display	Meaning
1 PWR	Green, continuous light	Operational readiness
	Red, continuous light	Sensor error
	Orange, continuous light	No function reserve
	Off	No supply voltage
2 Q1	Yellow, continuous light	Object detected
3 Q2	Yellow, continuous light	Object detected
4	Yellow, continuous light (behind lens cover)	Object detected
5	Yellow, continuous light (behind lens cover)	Object detected

Part number code



Part designation: ODS10XX-YYY.Z/ABC,DDD-EEE



ODS10	Operating principle ODS10: Optical distance sensor
XX	Light source L1: laser class 1
YYY	Measurement range 25M: Extended measurement range 50 ... 25000mm, measurement on HighGain tape REF 7-A-100x100
Z	Equipment 8: OLED display and membrane keyboard for configuration
A	Assignment pin 4 L: IO-Link (with dual channel, also push/pull switching output)
B	Assignment pin 2 A: Analog output current (factory setting) and voltage 6: push-pull switching output, PNP light switching, NPN dark switching



Part number code

C	Assignment pin 5 K: Multifunction input (factory setting: deactivation input) 6: push-pull switching output, PNP light switching, NPN dark switching X: pin not used
DDD-EEE	Electrical connection M12: M12 connector, 5-pin 200-M12: Cable, length 200 mm with M12 connector, 5-pin YYYY: Cable, length YYYY mm with wire-end sleeves, 5-wire (no information = standard length 2000 mm)
Note	
	A list with all available device types can be found on the Leuze website at www.leuze.com .

Notes

 Observe intended use!	
	<ul style="list-style-type: none"> ⌘ This product is not a safety sensor and is not intended as personnel protection. ⌘ The product may only be put into operation by competent persons. ⌘ Only use the product in accordance with its intended use.

 For UL applications:	
	<ul style="list-style-type: none"> ⌘ For UL applications, use is only permitted in Class 2 circuits in accordance with the NEC (National Electric Code).

 WARNING! LASER RADIATION – CLASS 1 LASER PRODUCT	
	<p>The device satisfies the requirements of IEC/EN 60825-1:2014 safety regulations for a product of laser class 1 and complies with 21 CFR 1040.10 except for conformance with IEC 60825-1 Ed. 3., as described in Laser Notice No. 56, dated May 8, 2019.</p> <ul style="list-style-type: none"> ⌘ Observe the applicable statutory and local laser protection regulations. ⌘ The device must not be tampered with and must not be changed in any way. There are no user-serviceable parts inside the device. Repairs must only be performed by Leuze electronic GmbH + Co. KG.

Accessories

Connection technology - Connection unit

	Part no.	Designation	Article	Description
	50144900	MD 798i-11-82/L5-2222	IO-Link master	Type: IO-Link master Current consumption, max.: 11,000 mA Switching outputs for each sensor connection: 1 Piece(s) Switching output: Transistor, PNP Interface: IO-Link, Automatic protocol detection, EtherNet IP, Modbus TCP, PROFINET Connections: 12 Piece(s) Sensor connections: 8 Piece(s) Connections for voltage supply: 2 Piece(s) Interface connections: 2 Piece(s) Degree of protection: IP 67, IP 65, IP 69K

Mounting technology - Mounting brackets

	Part no.	Designation	Article	Description
	50118543	BT 300M.5	Mounting bracket	Design of mounting device: Angle, L-shape Fastening, at system: Through-hole mounting Mounting bracket, at device: Screw type, Suited for M4 screws Type of mounting device: Adjustable Material: Stainless steel

Mounting technology - Rod mounts

	Part no.	Designation	Article	Description
	50117252	BTU 300M-D12	Mounting system	Design of mounting device: Mounting system Fastening, at system: For 12 mm rod, Sheet-metal mounting Mounting bracket, at device: Screw type, Suited for M4 screws Type of mounting device: Clampable, Adjustable, Turning, 360° Material: Metal

Configuration devices

	Part no.	Designation	Article	Description
	50121098	SET MD12-US2-IL1.1 + Zub.	Diagnostics set	Interface: USB Connections: 2 Piece(s) Degree of protection: IP 20

Note



A list with all available accessories can be found on the Leuze website in the Download tab of the article detailed page.