

Technical data sheet

Diffuse sensor with background suppression

Part no.: 50148173

HT53C.V/LG-M8



For illustration purposes only

Contents

- Technical data
- Dimensioned drawings
- Electrical connection
- Diagrams
- Operation and display
- Part number code
- Notes
- Further information
- Accessories



Technical data

Basic data

| | |
|---------------------|--|
| Series | 53C |
| Operating principle | Diffuse reflection principle with background suppression |
| Application | Detection of high-gloss or polished surfaces Detection of transparent objects |

Special version

| | |
|-----------------|----------------------------|
| Special version | HYGIENE design V-optics |
|-----------------|----------------------------|

Optical data

| | |
|-----------------------------|--|
| Black-white error | < 10% up to 100 mm |
| Operating range | Guaranteed operating range |
| Operating range, white 90% | 0.015 ... 0.15 m |
| Operating range, gray 18% | 0.015 ... 0.13 m |
| Operating range, black 6% | 0.015 ... 0.11 m |
| Operating range limit | 0.015 ... 0.15 m (typical operating range) |
| Adjustment range | 20 ... 150 mm |
| Beam path | Focused |
| Light source | LED, Red |
| Wavelength | 645 nm |
| Transmitted-signal shape | Pulsed |
| LED group | Exempt group (in acc. with EN 62471) |
| Type of light spot geometry | Round |
| Light beam exit | Front 11° angle |
| Focus | Fixed |
| Focal distance | 150 mm |

Electrical data

| | |
|--------------------|---|
| Protective circuit | Polarity reversal protection Short circuit protected |
|--------------------|---|

Performance data

| | |
|----------------------|--|
| Supply voltage U_B | 10 ... 30 V, DC, Incl. residual ripple |
| Residual ripple | 0 ... 15 %, From U_B |
| Open-circuit current | 0 ... 15 mA |

Outputs

| | |
|-------------------------------------|------------|
| Number of digital switching outputs | 2 Piece(s) |
|-------------------------------------|------------|

Switching outputs

| | |
|-------------------------|---|
| Type | Digital switching output |
| Voltage type | DC |
| Switching current, max. | 100 mA |
| Switching voltage | high: $\geq(U_B - 2V)$ low: $\leq 2 V$ |

Switching output 1

| | |
|---------------------|--|
| Assignment | Connection 1, pin 4 |
| Switching element | Transistor, Push-pull |
| Switching principle | IO-Link / light switching (PNP)/dark switching (NPN) |

Switching output 2

| | |
|---------------------|--|
| Assignment | Connection 1, pin 2 |
| Switching element | Transistor, Push-pull |
| Switching principle | Dark switching (PNP)/light switching (NPN) |

Time behavior

| | |
|---------------------|-------------|
| Switching frequency | 1,000 Hz |
| Response time | 0.5 ms |
| Readiness delay | 300 ms |
| Response jitter | 166 μ s |

Interface

| | |
|------------------|----------------------|
| Type | IO-Link |
| IO-Link | |
| COM mode | COM2 |
| Profile | Smart sensor profile |
| Min. cycle time | COM2 = 2.3 ms |
| Frame type | 2.5 |
| Specification | V1.1 |
| Device ID | 6002 |
| SIO-mode support | Yes |

Connection

| | |
|-----------------------|------------|
| Number of connections | 1 Piece(s) |
|-----------------------|------------|

Connection 1

| | |
|--------------------|---|
| Function | Signal IN Signal OUT Voltage supply |
| Type of connection | Connector |
| Thread size | M8 |
| Type | Male |
| Material | Stainless steel |
| No. of pins | 4 -pin |

Mechanical data

| | |
|---------------------------------|---|
| Dimension (W x H x L) | 14 mm x 35.4 mm x 20.4 mm |
| Housing material | Stainless steel |
| Stainless steel housing | AISI 316L, DIN X2CrNiMo17132, W. No1.4404 |
| Material of operational control | Plastic (POM Hostaform C9021, copolyester Tritan TX1001), non-diffusive |
| Housing roughness | Ra \leq 0,8, Typical value for the stainless steel housing |
| Lens cover material | Plastic (PMMA+) with scratch-resistant Indium protective coating |
| Net weight | 48 g |
| Housing color | Silver |
| Type of fastening | Housing fit |
| Compatibility of materials | CleanProof+ ECOLAB Johnson Diversey |

Operation and display

| | |
|-------------------------------------|-------------------------|
| Type of display | LED |
| Number of LEDs | 2 Piece(s) |
| Operational controls | Multiturn potentiometer |
| Function of the operational control | Range adjustment |

Environmental data

| | |
|--------------------------------|-------------------------------------|
| Ambient temperature, operation | -40 ... 60 °C, (70 °C \leq 15min) |
| Ambient temperature, storage | -40 ... 70 °C |

Technical data**Certifications**

| | |
|-----------------------------|---------------|
| Degree of protection | IP 67 |
| | IP 68 |
| | IP 69K |
| Protection class | III |
| Approvals | c UL US |
| Standards applied | IEC 60947-5-2 |

Classification

| | |
|------------------------------|----------|
| Customs tariff number | 85365019 |
| ECLASS 5.1.4 | 27270904 |
| ECLASS 8.0 | 27270904 |
| ECLASS 9.0 | 27270904 |
| ECLASS 10.0 | 27270904 |
| ECLASS 11.0 | 27270904 |
| ECLASS 12.0 | 27270903 |
| ECLASS 13.0 | 27270903 |
| ECLASS 14.0 | 27270903 |
| ECLASS 15.0 | 27270903 |
| ECLASS 16.0 | 27270903 |
| ETIM 5.0 | EC002719 |
| ETIM 6.0 | EC002719 |
| ETIM 7.0 | EC002719 |
| ETIM 8.0 | EC001821 |
| ETIM 9.0 | EC001821 |
| ETIM 10.0 | EC001821 |
| UNSPSC 26.08 | 39121528 |

Dimensioned drawings

All dimensions in millimeters

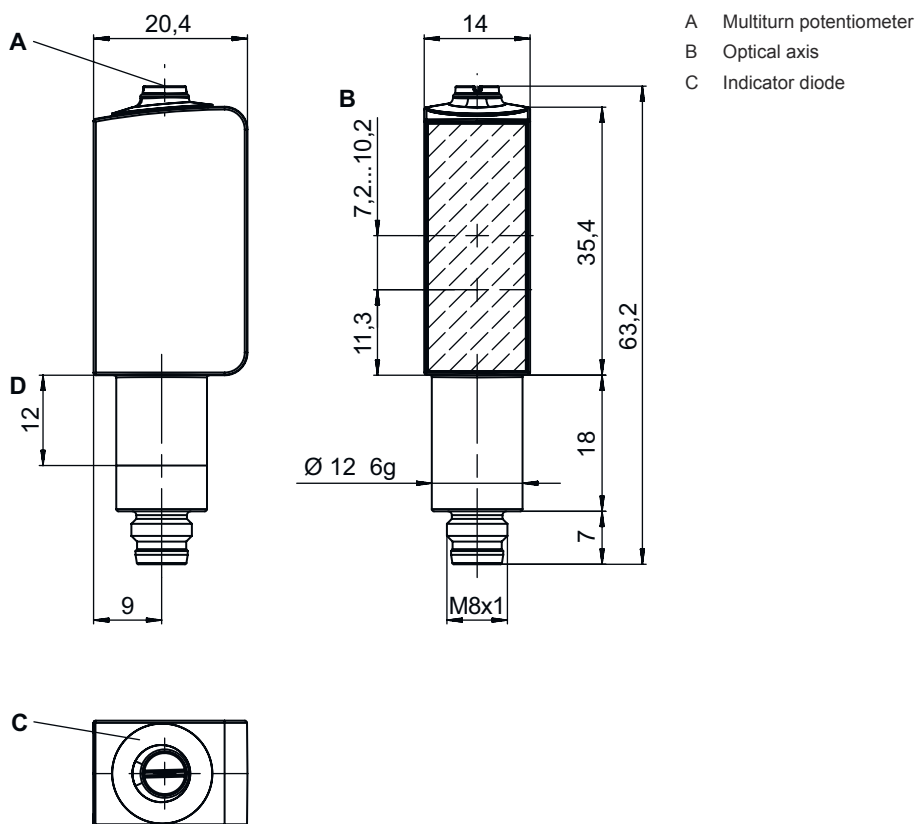

Electrical connection

Connection 1

| | |
|--------------------|-----------------|
| Function | Signal IN |
| | Signal OUT |
| | Voltage supply |
| Type of connection | Connector |
| Thread size | M8 |
| Type | Male |
| Material | Stainless steel |
| No. of pins | 4 -pin |

| Pin | Pin assignment |
|-----|-----------------|
| 1 | V+ |
| 2 | OUT 2 |
| 3 | GND |
| 4 | IO-Link / OUT 1 |

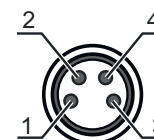

Diagrams

Typ. response behavior (white 90 %)

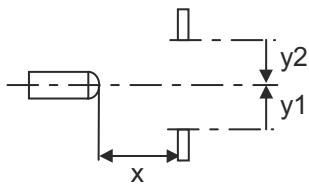
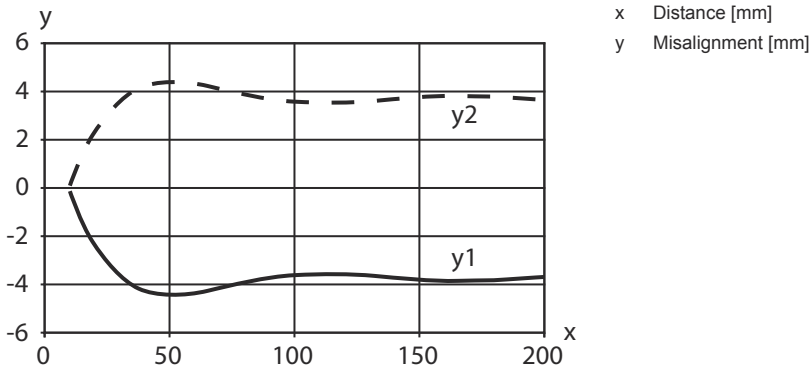

Typ. black/white behavior

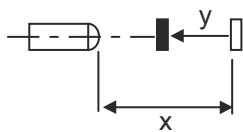
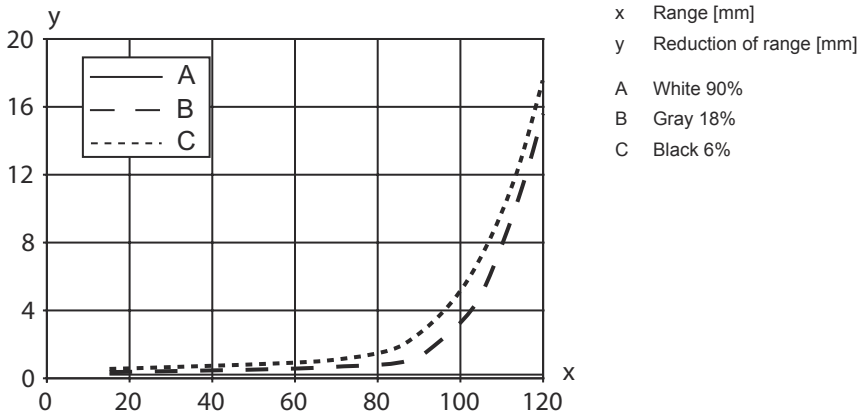

Operation and display

| LED | Display | Meaning |
|-----|--------------------------|-----------------------|
| 1 | Green, continuous light | Operational readiness |
| 2 | Yellow, continuous light | Object detected |

Part number code

Part designation: AAA53C d EE-f.GGGG H/i J-K.LL

| | |
|---------------|---|
| AAA53C | Operating principle / construction HT53C: Diffuse reflection sensor with background suppression LS53C: Throughbeam photoelectric sensor transmitter LE53C: Throughbeam photoelectric sensor receiver PRK53C: Retro-reflective photoelectric sensor with polarization filter ODT53C: Distance diffuse sensor with background suppression |
| d | Light type n/a: red light l: infrared light |
| EE | Light source n/a: LED L1: laser class 1 L2: laser class 2 |
| f | Preset range (optional) n/a: operating range acc. to data sheet xxxF: Preset range [mm] |
| GGGG | Equipment n/a: standard A: Autocollimation principle (single lens) for positioning tasks F: Permanently set range H2O: Detection of aqueous liquids Fill-level monitoring S: small light spot T: autocollimation principle (single lens) for highly transparent bottles without tracking TT: autocollimation principle (single lens) for highly transparent bottles with tracking V: V-optics XL: Extra long light spot X: extended model |
| H | Operating range adjustment n/a with HT: range adjustable via 8-turn potentiometer n/a with retro-reflective photoelectric sensors (PRK): operating range not adjustable 1: 270° potentiometer 3: teach-in via button |
| i | Switching output/function OUT 1/IN: Pin 4 or black conductor 2: NPN transistor output, light switching N: NPN transistor output, dark switching 4: PNP transistor output, light switching P: PNP transistor output, dark switching 6: push-pull switching output, PNP light switching, NPN dark switching G: Push-pull switching output, PNP dark switching, NPN light switching L: IO-Link interface (SIO mode: PNP light switching, NPN dark switching) 8: activation input (activation with high signal) X: pin not used 1: IO-Link / light switching (NPN) / dark switching (PNP) 7: Input for sensitivity adjustment |
| J | Switching output / function OUT 2/IN: pin 2 or white conductor 2: NPN transistor output, light switching N: NPN transistor output, dark switching 4: PNP transistor output, light switching P: PNP transistor output, dark switching 6: push-pull switching output, PNP light switching, NPN dark switching G: Push-pull switching output, PNP dark switching, NPN light switching T: teach-in via cable X: pin not used 8: activation input (activation with high signal) 9: deactivation input (deactivation with high signal) |
| K | Electrical connection M8: M8 connector, 4-pin (plug) |
| LL | Parameterization P1: different configuration |

Note



A list with all available device types can be found on the Leuze website at www.leuze.com.

Notes



Observe intended use!



- ⌘ This product is not a safety sensor and is not intended as personnel protection.
- ⌘ The product may only be put into operation by competent persons.
- ⌘ Only use the product in accordance with its intended use.

For UL applications:



- ⌘ For UL applications, use is only permitted in Class 2 circuits in accordance with the NEC (National Electric Code).
- ⌘ These proximity switches shall be used with UL Listed Cable assemblies rated 30V, 0.5A min, in the field installation, or equivalent (categories: CYJV/ CYJV7 or PVVA/PVVA7)

Further information

- Light source: Average life expectancy 100,000 h at an ambient temperature of 25 °C
- Response time: For short decay times, an ohmic load of approx. 5kOhm is recommended
- Sum of the output currents for both outputs, 50 mA for ambient temperatures > 40 °C
- Permissible operating temperature range during IO-Link operation: -10 °C to +60 °C
- IP 69K only with internal tube installation of M8 connector
- Ambient temperature, operation: +70 °C permissible only briefly (≤ 15min)
- Operating ambient temperature: +65 °C (continuous) up to max. 27 V DC supply voltage

Accessories

Connection technology - Connection unit

| | Part no. | Designation | Article | Description |
|--|----------|-----------------------|----------------|---|
|  | 50144900 | MD 798i-11-82/L5-2222 | IO-Link master | Current consumption, max.: 11,000 mA Interface: IO-Link, Automatic protocol detection, EtherNet IP, Modbus TCP, PROFINET Connections: 12 Piece(s) Sensor connections: 8 Piece(s) Degree of protection: IP 67, IP 65, IP 69K |

Connection technology - Connection cables

| | Part no. | Designation | Article | Description |
|---|----------|-------------------|------------------|---|
|  | 50130856 | KD U-M8-4A-P1-050 | Connection cable | Application: Oil and lubricant resistant Connection 1: Connector, M8, Axial, Female, 4 -pin Connector, LED: No Connection 2: Open end Shielded: No Cable length: 5,000 mm Sheathing material: PUR |

Accessories

| | Part no. | Designation | Article | Description |
|---|----------|--------------------------|------------------|---|
|  | 50148347 | KD U-M8-4A-T0-050 F+B | Connection cable | Application: Chemical resistant, Hygienic and wet areas Connection 1: Connector, M8, Axial, Female, A-coded, 4 -pin Connector, LED: No Connection 2: Open end Shielded: No Cable length: 5,000 mm Sheathing material: TPE |

Mounting technology - Other

| | Part no. | Designation | Article | Description |
|---|----------|-------------------|-----------------|---|
|  | 50145361 | BTU 053M.5F-D12-T | Mounting system | Design of mounting device: Mounting system Fastening, at system: Screw type Mounting bracket, at device: For 12 mm rod Type of mounting device: Turning, 360°, Adjustable Material: Stainless steel |

Note



↪ A list with all available accessories can be found on the Leuze website in the Download tab of the article detailed page.