

## Technical data sheet

### Safety laser scanner

Part no.: 53800104  
RSL440-S



For illustration purposes only

#### Contents

- Technical data
- Dimensioned drawings
- Operation and display
- Notes
- Accessories



## Technical data

### Basic data

Series	RSL 400
Application	Mobile danger zone guarding Mobile side guarding Stationary access guarding Stationary danger zone guarding

### Functions

Functions	Data output, configurable Dynamic contactor monitoring (EDM), selectable E-stop linkage Four-field mode Safe time delay, internal Start/restart interlock (RES), selectable
-----------	--------------------------------------------------------------------------------------------------------------------------------------------------------------------------------------------

### Characteristic parameters

Type	3, IEC/EN 61496
SIL	2, IEC 61508
SILCL	2, IEC/EN 62061
Performance Level (PL)	d, EN ISO 13849-1
PFH <sub>D</sub>	9E-08 per hour
Mission time T <sub>M</sub>	20 years, EN ISO 13849-1
Category	3, EN ISO 13849

### Protective field data

Resolution (adjustable)	30/40/50/60/70/150 mm
Minimum adjustable range	50 mm
Number of field pairs, switchable	Up to 100
Number of quads, switchable	50
Number of protective functions	2 Piece(s)
Number of independent sensor configurations	Up to 10
Diffuse reflection, min.	1.8 %
Operating range	0 ... 3 m

### Warning field data

Number of field pairs	Up to 100
Operating range	0 ... 20 m
Object size	150 mm x 150 mm
Diffuse reflection, min.	10 %

### Optical data

Light source	Laser, Infrared
Wavelength	905 nm
Laser class	1, IEC/EN 60825-1:2014
Transmitted-signal shape	Pulsed
Repetition frequency	90 kHz
Angular resolution	0.1 °
Scanning angle	270 °

### Electrical data

Protective circuit	Overvoltage protection
<b>Performance data</b>	
Supply voltage U <sub>B</sub>	24 V, DC, -30 ... 20 %
Current consumption (without load), max.	700 mA, (use power supply unit with 3 A)
Power consumption, max.	17 W, For 24 V, plus output load

### Outputs

Number of safety-related switching outputs (OSSDs)	4 Piece(s)
----------------------------------------------------	------------

#### Safety-related switching outputs

Type	Safety-related switching output OSSD
Switching voltage high, min.	20.8 V
Switching voltage low, max.	2 V
Voltage type	DC

#### Safety-related switching output 1

Switching element	Transistor, PNP
-------------------	-----------------

#### Safety-related switching output 2

Switching element	Transistor, PNP
-------------------	-----------------

#### Safety-related switching output 3

Switching element	Transistor, PNP
-------------------	-----------------

#### Safety-related switching output 4

Switching element	Transistor, PNP
-------------------	-----------------

### Time behavior

Response time	80 ms, ≥
---------------	----------

### Service interface

Type	Bluetooth, Ethernet, USB
------	--------------------------

#### Ethernet

Function	Configuration/parametization TCP/IP
Connection	M12 connector, 4-pin, D-coded

#### Bluetooth

Function	Configuration/parametization
Frequency band	2,400 ... 2,483.5 MHz
Radiated transmitting power	Max. 4.5 dBm (2.82 mW), class 2

#### USB

Function	Configuration/parametization
Connection	USB 2.0 mini-B, socket
Transmission speed, max.	12 Mbit/s
Cable length	≤ 5m Longer cable lengths are possible using active cables.

### Connection

#### Cable properties

Cable resistance, max.	15 Ω
------------------------	------

### Mechanical data

Dimension (W x H x L)	140 mm x 149 mm x 140 mm
Housing material	Metal Plastic
Metal housing	Diecast zinc
Lens cover material	Plastic/PC
Net weight	2,000 g
Housing color	Yellow, RAL 1021
Type of fastening	Mounting plate Through-hole mounting Via optional mounting device

## Technical data

### Operation and display

Type of display	Alphanumerical display LED indicator
Number of LEDs	6 Piece(s)
Type of configuration	Software Sensor Studio
Operational controls	Software Sensor Studio

### Environmental data

Ambient temperature, operation	0 ... 50 °C
Ambient temperature, storage	-20 ... 60 °C
Relative humidity (non-condensing)	15 ... 95 %

### Certifications

Degree of protection	IP 65
Protection class	III, EN 61140
Approvals	c TÜV Süd US c UL US TÜV Süd
Test procedure for EMC in accordance with standard	DIN 40839-1/3 EN 61496-1
Test procedure for oscillation in accordance with standard	EN 60068-2-6
Test procedure for continuous shock in accordance with standard	IEC 60068-2-29
US patents	US 10,304,307B US 7,656,917 B US 7,696,468 B

### Classification

Customs tariff number	85365019
ECLASS 5.1.4	27279290
ECLASS 8.0	27279290
ECLASS 9.0	27272705
ECLASS 10.0	27272791
ECLASS 11.0	27272791
ECLASS 12.0	27272791
ECLASS 13.0	27272791
ECLASS 14.0	27272791
ECLASS 15.0	27272791
ECLASS 16.0	27272791
ETIM 5.0	EC002550
ETIM 6.0	EC002550
ETIM 7.0	EC002550
ETIM 8.0	EC003015
ETIM 9.0	EC003015
ETIM 10.0	EC003015
UNSPSC 26.08	31242100

## Dimensioned drawings

All dimensions in millimeters

Dimensions safety laser scanner with connection unit

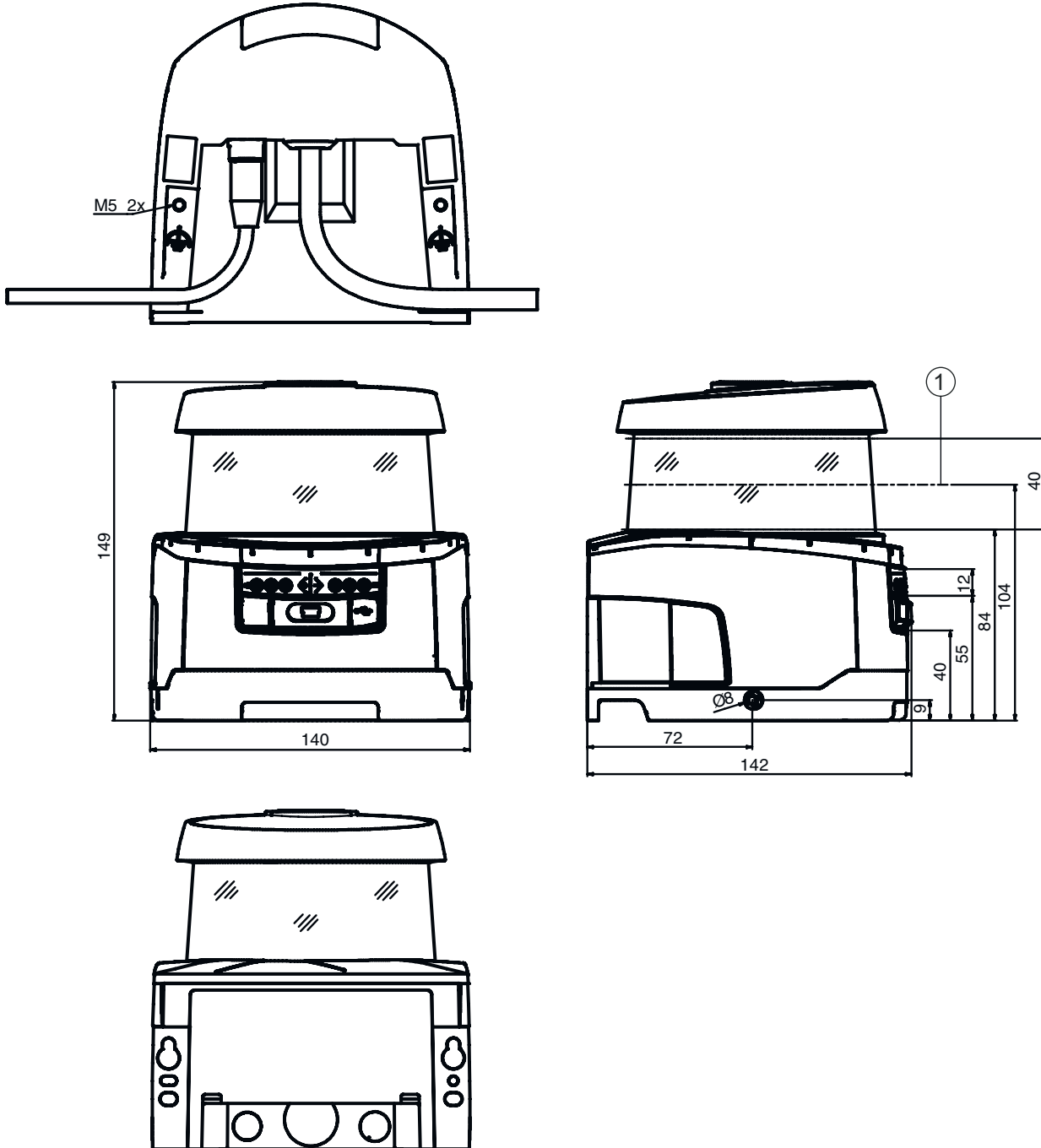

1 Scan level

## Dimensioned drawings

Mounting dimensions safety laser scanner with connection unit

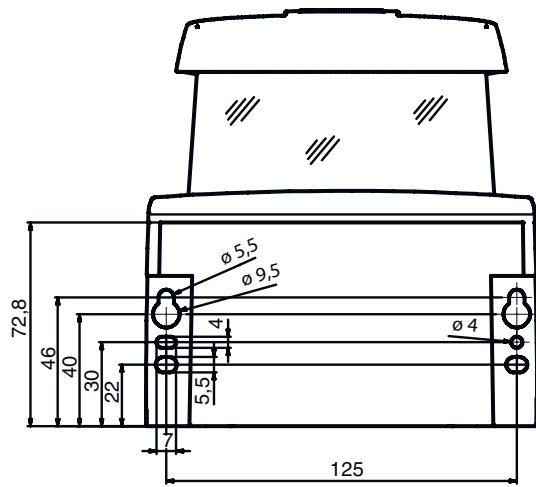

Minimum space requirements for installation and replacement of scanner unit

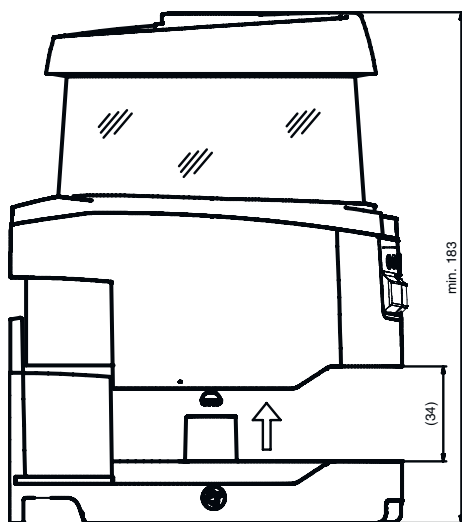

# Dimensioned drawings

## Dimensions of scanning range



1 Reference point for distance measurement and protective field radius

## Operation and display

LED	Display	Meaning
1	Off	Device switched off
	Red, continuous light	OSSD off
	Red, flashing	Error
	Green, continuous light	OSSD on
2	Off	RES deactivated or RES activated and released
	Yellow, flashing	Protective field occupied
	Yellow, continuous light	RES activated and blocked but ready to be unlocked - protective field free and linked sensor is enabled if applicable
3	Off	Free warning field
	Blue, continuous light	Warning field interrupted
4	Off	Free warning field
	Blue, continuous light	Warning field interrupted
5	Off	RES deactivated or RES activated and released
	Yellow, flashing	Protective field occupied
	Yellow, continuous light	RES activated and blocked but ready to be unlocked - protective field free and linked sensor is enabled if applicable
6	Off	Device switched off
	Red, continuous light	OSSD off
	Red, flashing	Error
	Green, continuous light	OSSD on

## Notes

**Observe intended use!**

	<ul style="list-style-type: none"> <li>☞ The product may only be put into operation by competent persons.</li> <li>☞ Only use the product in accordance with its intended use.</li> </ul>
--	-------------------------------------------------------------------------------------------------------------------------------------------------------------------------------------------

## Notes



### ATTENTION! INVISIBLE LASER RADIATION – CLASS 1 LASER PRODUCT



The device satisfies the requirements of IEC/EN 60825-1:2014 safety regulations for a product of **laser class 1** and complies with 21 CFR 1040.10 except for conformance with IEC 60825-1 Ed. 3., as described in Laser Notice No. 56, dated May 8, 2019.

↳ Observe the applicable statutory and local laser protection regulations.



↳ The device must not be tampered with and must not be changed in any way.  
There are no user-serviceable parts inside the device.  
Repairs must only be performed by Leuze electronic GmbH + Co. KG.

## Accessories

### Connection technology - Connection boxes

	Part no.	Designation	Article	Description
	53800122	CU429-10000	Connection unit	Number of connections: 2 Piece(s) Connection 1: Cable, 10,000 mm, PUR, 29 -wire Connection 2: Connector, M12, D-coded, 5 -pin Color: Black Type of fastening: Bayonet system

### Mounting technology - Mounting brackets

	Part no.	Designation	Article	Description
	53800134	BT840M	Mounting bracket	Application: Mounting on chamfered 90° corner Color: Yellow, RAL 1021 Type of fastening, at system: Through-hole mounting Type of fastening, at device: Screw type Material: Metal
	53800132	BTF815M	Mounting bracket	Application: Mounting bracket for floor mounting Scan level height: 150 mm Color: Yellow, RAL 1021 Type of fastening, at system: Through-hole mounting Type of fastening, at device: Screw type Material: Metal
	53800133	BTF830M	Mounting bracket	Application: Mounting bracket for floor mounting Scan level height: 300 mm Color: Yellow, RAL 1021 Type of fastening, at system: Through-hole mounting Type of fastening, at device: Screw type Material: Metal

### Mounting technology - Other

	Part no.	Designation	Article	Description
	53800130	BTU800M	Mounting system	Color: Black Type of fastening, at system: Through-hole mounting Type of fastening, at device: Screw type Material: Metal

## Accessories

### General

	Part no.	Designation	Article	Description
	430400	RS4-clean-Set1	Cleaning set	Number of cleaning cloths: 40 Piece(s) Content of cleaning fluid: 150 ml Net weight: 616 g

### Services

	Part no.	Designation	Article	Description
	S981051	CS40-I-141	Safety inspection	Details: Checking of a safety laser scanner application in accordance with current standards and guidelines. Inclusion of the device and machine data in a database, production of a test log per application. Conditions: It must be possible to stop the machine, support provided by customer's employees and access to the machine for Leuze employees must be ensured.
	S981047	CS40-S-141	Start-up support	Details: For safety devices including stopping time measurement and initial inspection. Conditions: Devices and connection cables are already mounted, price not including travel costs and, if applicable, accommodation expenses.

#### Note



A list with all available accessories can be found on the Leuze website in the Download tab of the article detailed page.