

Technical data sheet

Diffuse sensor with background suppression

Part no.: 50131552

HT46C.SL/4X-200-M12



For illustration purposes only

Contents

- Technical data
- Dimensioned drawings
- Electrical connection
- Diagrams
- Operation and display
- Part number code
- Notes
- Further information
- Accessories



Technical data

Basic data

| | |
|---------------------|---|
| Series | 46C |
| Operating principle | Diffuse reflection principle with background suppression |
| Application | Object detection between the rollers of a roller conveyor |

Special version

| | |
|-----------------|----------------------|
| Special version | Small light spot (S) |
|-----------------|----------------------|

Optical data

| | |
|-----------------------------|--|
| Black-white error | < 10% up to 800 mm |
| Operating range | Guaranteed operating range |
| Operating range, white 90% | 0.01 ... 1.2 m |
| Operating range, gray 18% | 0.015 ... 1 m |
| Operating range, black 6% | 0.02 ... 0.8 m |
| Operating range limit | 0.01 ... 1.2 m (typical operating range) |
| Adjustment range | 120 ... 1,200 mm |
| Beam path | Focused |
| Light source | LED, Red |
| Wavelength | 630 nm |
| Transmitted-signal shape | Pulsed |
| LED group | Exempt group (in acc. with EN 62471) |
| Type of light spot geometry | Rectangular |
| Focus | Fixed |

Electrical data

| | |
|--------------------|------------------------------|
| Protective circuit | Polarity reversal protection |
| | Short circuit protected |
| | Transient protection |

Performance data

| | |
|----------------------|--|
| Supply voltage U_B | 10 ... 30 V, DC, Incl. residual ripple |
| Residual ripple | 0 ... 15 %, From U_B |
| Open-circuit current | 0 ... 30 mA |

Outputs

| | |
|-------------------------------------|------------|
| Number of digital switching outputs | 1 Piece(s) |
|-------------------------------------|------------|

Switching outputs

| | |
|-------------------------|---|
| Type | Digital switching output |
| Voltage type | DC |
| Switching current, max. | 100 mA |
| Switching voltage | high: $\geq(U_B - 2V)$ low: $\leq 2 V$ |

Switching output 1

| | |
|---------------------|---------------------|
| Assignment | Connection 1, pin 4 |
| Switching element | Transistor, PNP |
| Switching principle | Light switching |

Time behavior

| | |
|---------------------|--------|
| Switching frequency | 250 Hz |
| Response time | 2 ms |
| Readiness delay | 300 ms |

Connection

| | |
|-----------------------|------------|
| Number of connections | 1 Piece(s) |
|-----------------------|------------|

Connection 1

| | |
|----------------------|------------------------------|
| Function | Signal OUT Voltage supply |
| Type of connection | Cable with connector |
| Cable length | 200 mm |
| Sheathing material | PUR |
| Cable color | Black |
| Number of conductors | 4 -wire |
| Wire cross section | 0.2 mm ² |
| Thread size | M12 |
| Type | Male |
| Material | Plastic |
| No. of pins | 4 -pin |
| Encoding | A-coded |

Mechanical data

| | |
|--|---|
| Dimension (W x H x L) | 20.5 mm x 76.3 mm x 44 mm |
| Housing material | Plastic |
| Plastic housing | PC-PBT |
| Lens cover material | Plastic / PMMA |
| Net weight | 65 g |
| Housing color | Red |
| Type of fastening | Through-hole mounting Via optional mounting device |
| Recommended tightening torque for M3 fastening | 0.9 N·m |
| Recommended tightening torque for M4 fastening | 1.4 N·m |
| Compatibility of materials | ECOLAB |

Operation and display

| | |
|-------------------------------------|-------------------------|
| Type of display | LED |
| Number of LEDs | 2 Piece(s) |
| Operational controls | Multiturn potentiometer |
| Function of the operational control | Range adjustment |

Environmental data

| | |
|--------------------------------|---------------|
| Ambient temperature, operation | -40 ... 60 °C |
| Ambient temperature, storage | -40 ... 70 °C |

Certifications

| | |
|----------------------|-----------------|
| Degree of protection | IP 67 IP 69K |
| Protection class | III |
| Approvals | c UL US |
| Standards applied | IEC 60947-5-2 |

Technical data

| | |
|-----------------------|----------|
| Customs tariff number | 85365019 |
| ECLASS 5.1.4 | 27270904 |
| ECLASS 8.0 | 27270904 |
| ECLASS 9.0 | 27270904 |
| ECLASS 10.0 | 27270904 |
| ECLASS 11.0 | 27270904 |
| ECLASS 12.0 | 27270903 |
| ECLASS 13.0 | 27270903 |
| ECLASS 14.0 | 27270903 |
| ECLASS 15.0 | 27270903 |
| ECLASS 16.0 | 27270903 |
| ETIM 5.0 | EC002719 |
| ETIM 6.0 | EC002719 |
| ETIM 7.0 | EC002719 |
| ETIM 8.0 | EC002719 |
| ETIM 9.0 | EC002719 |
| ETIM 10.0 | EC002719 |
| UNSPSC 26.08 | 39121528 |

Dimensioned drawings

All dimensions in millimeters

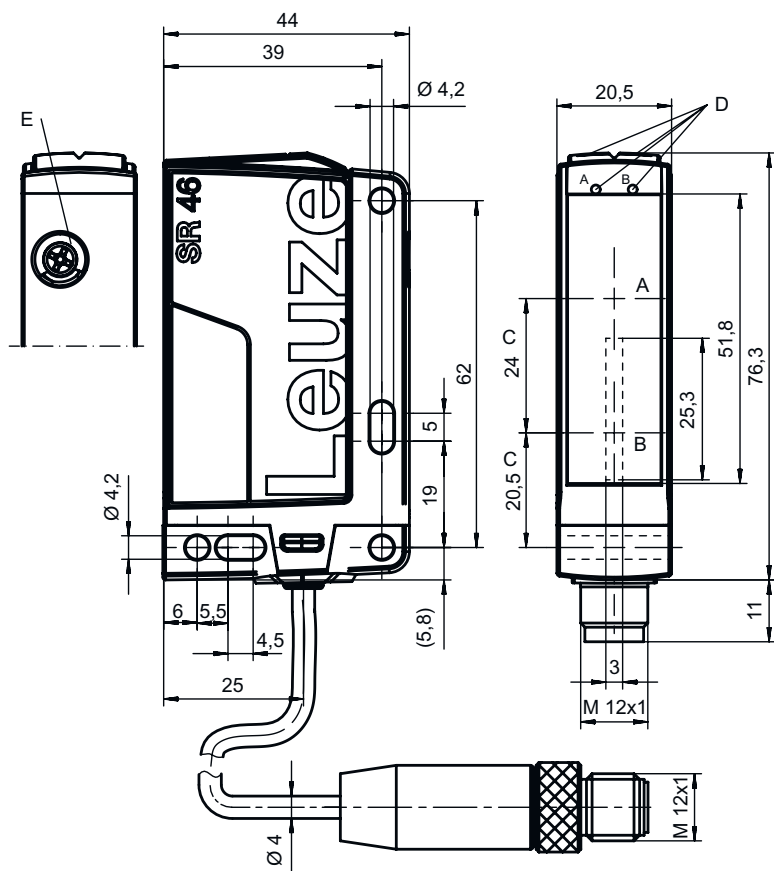

- A Receiver
- B Yellow LED
- C Optical axis
- DA Green LED
- DB Yellow LED
- E Multiturn potentiometer

Electrical connection

Connection 1

| | |
|----------------------|----------------------|
| Function | Signal OUT |
| | Voltage supply |
| Type of connection | Cable with connector |
| Cable length | 200 mm |
| Sheathing material | PUR |
| Cable color | Black |
| Number of conductors | 4 -wire |
| Wire cross section | 0.2 mm ² |
| Thread size | M12 |
| Type | Male |
| Material | Plastic |
| No. of pins | 4 -pin |
| Encoding | A-coded |

| Pin | Pin assignment |
|-----|----------------|
| 1 | V+ |
| 2 | n.c. |
| 3 | GND |
| 4 | OUT 1 |

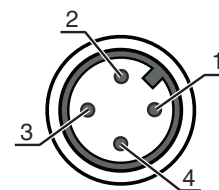

Diagrams

Typ. response behavior

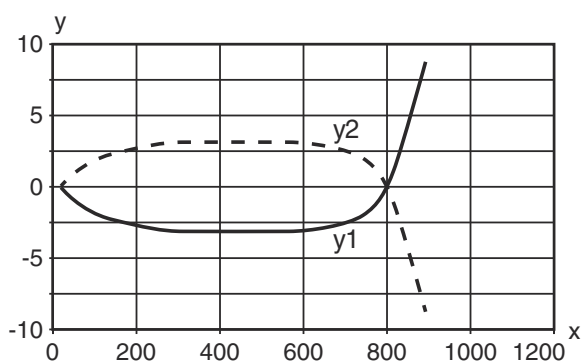

x Distance [mm]
y Misalignment [mm]

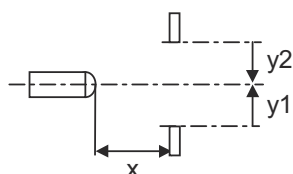

Diagrams

Typ. black/white behavior

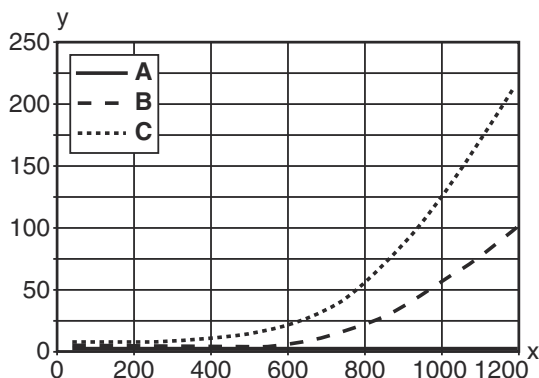

x Range [mm]
 y Reduction of range [mm]
 A White 90%
 B Gray 18%
 C Black 6%



Operation and display

| LED | Display | Meaning |
|-----|--------------------------|-----------------------|
| 1 | Green, continuous light | Operational readiness |
| 2 | Yellow, continuous light | Reflection |

Part number code

Part designation: **AAA46C d EE-f.GG H/i J-K**

| | |
|---------------|---|
| AAA46C | Operating principle / construction HT46C: Diffuse reflection sensor with background suppression LS46C: Throughbeam photoelectric sensor transmitter LE46C: Throughbeam photoelectric sensor receiver PRK46C: Retro-reflective photoelectric sensor with polarization filter RK46C: Retro-reflective photoelectric sensor |
| d | Light type n/a: red light I: infrared light |
| EE | Light source n/a: LED L1: laser class 1 L2: laser class 2 |
| f | Preset range (optional) n/a: operating range acc. to data sheet xxxF: Preset range [mm] |
| GG | Equipment n/a: standard 1: 270° potentiometer 8: activation input (activation with high signal) 01: diffuse reflection sensor with background suppression (HT): HG tape (HighGain tape) is not detected from a distance of 900 mm with a set operating range of ≤ 450 mm (diffuse reflection: 6%, black) D: Depolarizing media E: Diffuse reflection sensor with background suppression (HT): optimized for dusty environments SL: Diffuse reflection sensor with background suppression (HT): slit diaphragm 25 mm x 3 mm P: throughbeam photoelectric sensor receiver (LE): edge filter for parallel operation L: Light-band XL: Extra long light spot |

Part number code

| | |
|----------|---|
| H | Operating range adjustment & version n/a with diffuse reflection sensor with background suppression (HT): range adjustment via mechanical adjusting spindle n/a with retro-reflective photoelectric sensors (PRK): operating range not adjustable 1: retro-reflective photoelectric sensors (PRK/RK): sensitivity adjustment via potentiometer 3: teach-in via button P2: resolution 2 mm |
| i | Switching output/function OUT 1/IN: Pin 4 or black conductor 2: NPN transistor output, light switching N: NPN transistor output, dark switching 4: PNP transistor output, light switching P: PNP transistor output, dark switching L: IO-Link G: Push-pull switching output, PNP dark switching, NPN light switching 6: push-pull switching output, PNP light switching, NPN dark switching |
| J | Switching output / function OUT 2/IN: pin 2 or white conductor 2: NPN transistor output, light switching N: NPN transistor output, dark switching 4: PNP transistor output, light switching P: PNP transistor output, dark switching 8: activation input (activation with high signal) 9: deactivation input (deactivation with high signal) W: warning output X: pin not used G: Push-pull switching output, PNP dark switching, NPN light switching 6: push-pull switching output, PNP light switching, NPN dark switching |
| K | Electrical connection n/a: cable, standard length 2000 mm, 4-wire 200-M12: cable, length 200 mm with M12 connector, 4-pin, axial (plug) M12: M12 connector, 4-pin (plug) 500-M12: cable, length 500 mm with M12 connector, 4-pin, axial (plug) 1000-M12: cable, length 1000 mm with M12 connector, 4-pin, axial (plug) |

Note



A list with all available device types can be found on the Leuze website at www.leuze.com.

Notes



Observe intended use!



- ⌘ This product is not a safety sensor and is not intended as personnel protection.
- ⌘ The product may only be put into operation by competent persons.
- ⌘ Only use the product in accordance with its intended use.

For UL applications:



- ⌘ For UL applications, use is only permitted in Class 2 circuits in accordance with the NEC (National Electric Code).
- ⌘ These proximity switches shall be used with UL Listed Cable assemblies rated 30V, 0.5A min, in the field installation, or equivalent (categories: CYJV/ CYJV7 or PVVA/PVVA7)

Further information

- Light source: Average life expectancy 100,000h at an ambient temperature of 25 °C
- Response time: For short decay times, an ohmic load of approx. 5kOhm is recommended

Accessories

Connection technology - Connection cables

| | Part no. | Designation | Article | Description |
|---|----------|--------------------|------------------|---|
|  | 50130652 | KD U-M12-4A-V1-050 | Connection cable | Application: Chemical resistant Connection 1: Connector, M12, Axial, Female, A-coded, 4 -pin Connector, LED: No Connection 2: Open end Shielded: No Cable length: 5,000 mm Sheathing material: PVC |
|  | 50130690 | KD U-M12-4W-V1-050 | Connection cable | Application: Chemical resistant Connection 1: Connector, M12, Angled, Female, A-coded, 4 -pin Connector, LED: No Connection 2: Open end Shielded: No Cable length: 5,000 mm Sheathing material: PVC |

Mounting technology - Mounting brackets

| | Part no. | Designation | Article | Description |
|---|----------|-------------|-----------------|--|
|  | 50105315 | BT 46 | Mounting device | Design of mounting device: Angle, L-shape Fastening, at system: Through-hole mounting Mounting bracket, at device: Screw type Type of mounting device: Rigid Material: Metal |

Mounting technology - Rod mounts

| | Part no. | Designation | Article | Description |
|---|----------|--------------|-----------------|---|
|  | 50117252 | BTU 300M-D12 | Mounting system | Contains: 2x M4 x 25 screw, 2x M4 x 20 screw, 4x position washers Design of mounting device: Mounting system Fastening, at system: For 12 mm rod, Sheet-metal mounting Mounting bracket, at device: Screw type, Suited for M4 screws Type of mounting device: Clampable, Adjustable, Turning, 360° Material: Metal |

Note



A list with all available accessories can be found on the Leuze website in the Download tab of the article detailed page.