

Technical data sheet

Ultrasonic distance sensor

Part no.: 50150580

DMU420B-500.3/LV-M8

Contents

- Technical data
- Dimensioned drawings
- Electrical connection
- Diagrams
- Operation and display
- Part number code
- Notes
- Accessories



For illustration purposes only



Technical data

Basic data

| | |
|--------|------|
| Series | 420B |
|--------|------|

Characteristic parameters

| | |
|------|-----------|
| MTTF | 425 years |
|------|-----------|

Ultrasonic specifications

| | |
|----------------------|-----------|
| Ultrasonic frequency | 290 kHz |
| Direction of beam | Front |
| Opening angle | 2 ... 9 ° |

Measurement data

| | |
|------------------------------------|---------------------|
| Measurement range | 15 ... 500 mm |
| Resolution | < 0,3 mm / < 0,5 mm |
| Accuracy | 2 % |
| Reference value, accuracy | End value |
| Repeatability | 0,5 mm, End value |
| Temperature drift | 2 % |
| Reference value, temperature drift | End value |

Electrical data

| | |
|--------------------|------------------------------|
| Protective circuit | Inductive protection |
| | Polarity reversal protection |
| | Short circuit protected |

Performance data

| | |
|----------------------|------------------------|
| Supply voltage U_B | 12 ... 30 V, DC |
| Residual ripple | 0 ... 10 %, From U_B |
| Open-circuit current | 0 ... 35 mA |
| Switching hysteresis | 4 % |

Outputs

| | |
|-------------------------------------|-------------------|
| Number of analog outputs | 1 Piece(s) |
| Number of digital switching outputs | 1 Piece(s) |
| Load resistance | > 10,000 Ω |

Analog outputs

| | |
|---------|------------|
| Voltage | 0 ... 10 V |
|---------|------------|

Analog output 1

| | |
|------|---------|
| Type | Voltage |
|------|---------|

Switching outputs

| | |
|-------------------------|-----------------|
| Voltage type | DC |
| Switching current, max. | 100 mA |
| Switching voltage | low: ≤ 2 V |

Switching output 1

| | |
|---------------------|--|
| Switching element | Transistor, Push-pull |
| Switching principle | IO-Link / light switching (PNP)/dark switching (NPN) |

Time behavior

| | |
|---------------------|---------|
| Switching frequency | 12 Hz |
| Response time | < 40 ms |
| Readiness delay | 300 ms |

Interface

| | |
|------|---------|
| Type | IO-Link |
|------|---------|

IO-Link

| | |
|----------------------|-------------|
| COM mode | COM2 |
| Min. cycle time | COM2 = 8 ms |
| Frame type | 2.2 |
| Specification | V1.1 |
| Device ID | 3100 |
| SIO-mode support | Yes |
| Process data, length | 48 bit |

Connection

| | |
|-----------------------|------------|
| Number of connections | 1 Piece(s) |
|-----------------------|------------|

Connection 1

| | |
|--------------------|----------------|
| Function | Signal IN |
| | Signal OUT |
| | Voltage supply |
| Type of connection | Connector |
| Thread size | M8 |
| Type | Male |
| Material | Metal |
| No. of pins | 4 -pin |

Mechanical data

| | |
|--------------------------------|--|
| Design | Cubic |
| Dimension (W x H x L) | 20,5 mm x 41 mm x 15 mm |
| Housing material | Plastic |
| Plastic housing | ASA, PMMA |
| Ultrasonic transducer material | Piezoceramics (contains lead zirconium titanate (PZT)) |
| Net weight | 22 g |
| Housing color | Red |
| Type of fastening | Through-hole mounting |

Operation and display

| | |
|-------------------------------------|------------------|
| Type of display | LED |
| Number of LEDs | 3 Piece(s) |
| Operational controls | Teach button |
| Function of the operational control | Range adjustment |

Environmental data

| | |
|--------------------------------|---------------|
| Ambient temperature, operation | -25 ... 65 °C |
| Ambient temperature, storage | -25 ... 75 °C |

Certifications

| | |
|----------------------|---------------|
| Degree of protection | IP 67 |
| Protection class | III |
| Approvals | c UL US |
| Standards applied | IEC 60947-5-2 |

Technical data

| | |
|-----------------------|----------|
| Customs tariff number | 85365019 |
| ECLASS 5.1.4 | 27272803 |
| ECLASS 8.0 | 27272803 |
| ECLASS 9.0 | 27272803 |
| ECLASS 10.0 | 27272803 |
| ECLASS 11.0 | 27272803 |
| ECLASS 12.0 | 27272803 |
| ECLASS 13.0 | 27272803 |
| ECLASS 14.0 | 27272803 |
| ETIM 5.0 | EC001849 |
| ETIM 6.0 | EC001849 |
| ETIM 7.0 | EC001849 |
| ETIM 8.0 | EC001849 |
| ETIM 9.0 | EC001849 |

Dimensioned drawings

All dimensions in millimeters

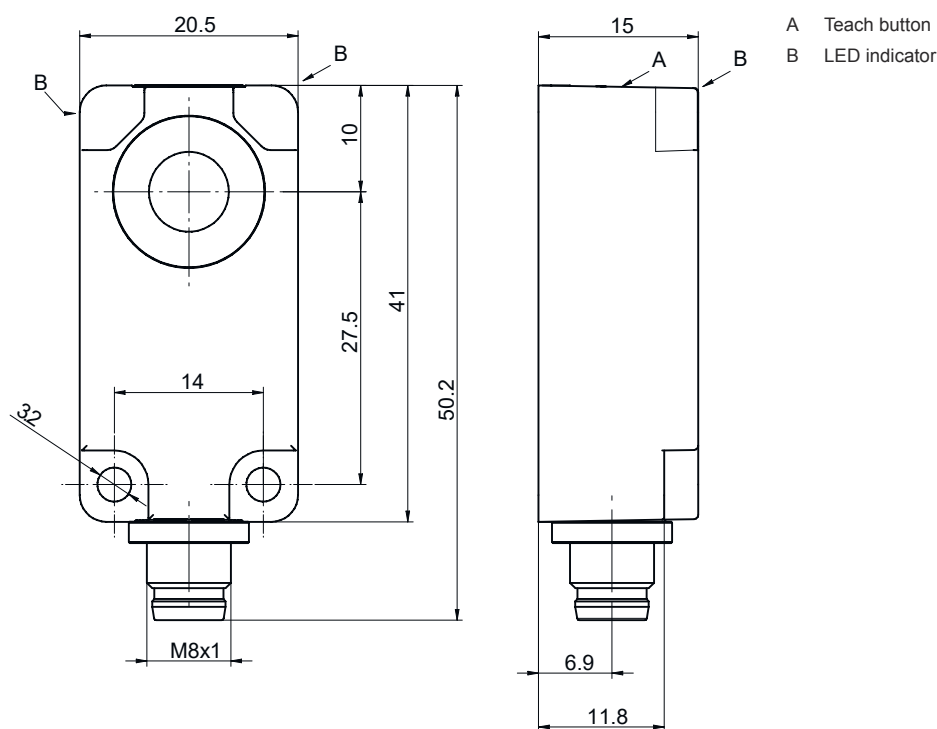

Electrical connection

Connection 1

| | |
|--------------------|----------------|
| Function | Signal IN |
| | Signal OUT |
| | Voltage supply |
| Type of connection | Connector |
| Thread size | M8 |
| Type | Male |
| Material | Metal |
| No. of pins | 4 -pin |

| Pin | Pin assignment |
|-----|-----------------|
| 1 | V+ |
| 2 | OUT V |
| 3 | GND |
| 4 | IO-Link / OUT 1 |

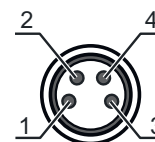

Diagrams

Typ. response behavior

Standard object, size 15 x 15 mm, aligned perpendicular to the sensor reference axis

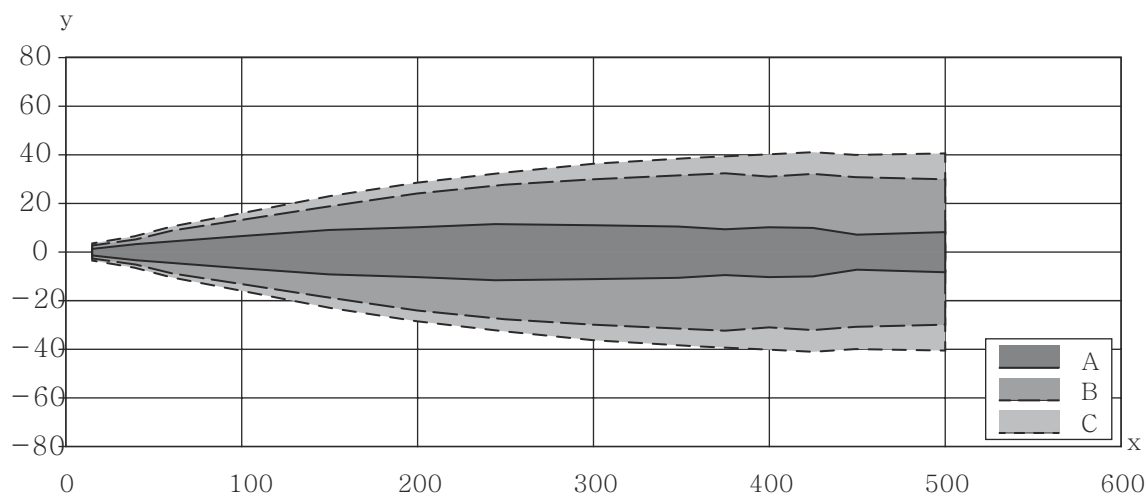

x Object distance to the sensor [mm]

y Lateral offset to the reference axis [mm]

- A Narrow
- B Medium
- C Wide

Operation and display

| LED | Display | Meaning |
|-----|--------------------------|-----------------------|
| 1 | Blue, continuous light | Teach active |
| 2 | Green, continuous light | Operational readiness |
| 3 | Yellow, continuous light | Object detected |

Part number code

Part designation: **AAA4BB-xxxx.C/DEF-GG**

| | |
|-------------|---|
| AAA | Operating principle HTU: Ultrasonic sensor, scanning principle, with background suppression DMU: Ultrasonic sensor, distance measurement |
| 4BB | Design 420B: Cubic 412B: Cylindrical with M12 thread |
| xxxx | Operating range Operating range in millimeters |
| C | Operating range adjustment 3: teach-in via button |
| D | Switching output / function OUT 1/IN: Pin 4 6: push-pull switching output, PNP light switching, NPN dark switching G: Push-pull switching output, PNP dark switching, NPN light switching L: IO-Link / light switching (PNP)/dark switching (NPN) |
| E | Switching output / function OUT 2/IN: pin 2 T: teach-in via cable C: Analog current output V: Analog voltage output X: pin not used 6: push-pull switching output, PNP light switching, NPN dark switching |
| F | Switching output / function OUT 3/IN: Pin 5 T: teach-in via cable |
| GG | Electrical connection M12: M12 connector M8: M8 connector |

| Note | |
|------|--|
| | A list with all available device types can be found on the Leuze website at www.leuze.com . |





Notes

| Observe intended use! | |
|------------------------------|---|
| | <ul style="list-style-type: none"> This product is not a safety sensor and is not intended as personnel protection. The product may only be put into operation by competent persons. Only use the product in accordance with its intended use. |

| For UL applications: | |
|-----------------------------|---|
| | For UL applications, use is only permitted in Class 2 circuits in accordance with the NEC (National Electric Code). |

Accessories

Connection technology - Connection cables

| | Part no. | Designation | Article | Description |
|---|----------|-------------------|------------------|--|
|   | 50130850 | KD U-M8-4A-V1-050 | Connection cable | Connection 1: Connector, M8, Axial, Female, 4 -pin Connector, LED: No Connection 2: Open end Shielded: No Cable length: 5.000 mm Sheathing material: PVC |
|   | 50130871 | KD U-M8-4W-V1-050 | Connection cable | Connection 1: Connector, M8, Angled, Female, 4 -pin Connector, LED: No Connection 2: Open end Shielded: No Cable length: 5.000 mm Sheathing material: PVC |

Note



A list with all available accessories can be found on the Leuze website in the Download tab of the article detailed page.