

Technical data sheet

Protective screen

Part no.: 347080

MLC-PS1500

Contents

- Technical data
- Dimensioned drawings
- Notes
- Accessories



For illustration purposes only

Technical data

Basic data

Contains	MLC-PS protective screen without bracket (bracket must be ordered separately)
Application	Protection of the device front panel in harsh environmental conditions
Suitable for	MLC 500, MLC 300 safety light curtains

Protective field data

Protective field height	1,500 mm
--------------------------------	----------

Mechanical data

Height	1,498 mm
Net weight	179 g
Protective screen material	PMMA, clear

Classification

Customs tariff number	39205100
ECLASS 5.1.4	27279290
ECLASS 8.0	27279290
ECLASS 9.0	27279090
ECLASS 10.0	27273792
ECLASS 11.0	27273792
ECLASS 12.0	27273792
ECLASS 13.0	27273792
ECLASS 14.0	27273792
ECLASS 15.0	27273792
ECLASS 16.0	27273792
ETIM 5.0	EC002498
ETIM 6.0	EC003015
ETIM 7.0	EC003015
ETIM 8.0	EC003015
ETIM 9.0	EC003015
ETIM 10.0	EC003015
UNSPSC 26.08	31242100

Dimensioned drawings

All dimensions in millimeters

- a Protective screen
- b M4 threaded pin
- c MLC transmitter or receiver
- d Mounting bracket
- e Countersunk screw M6 x 10 and slotted nut

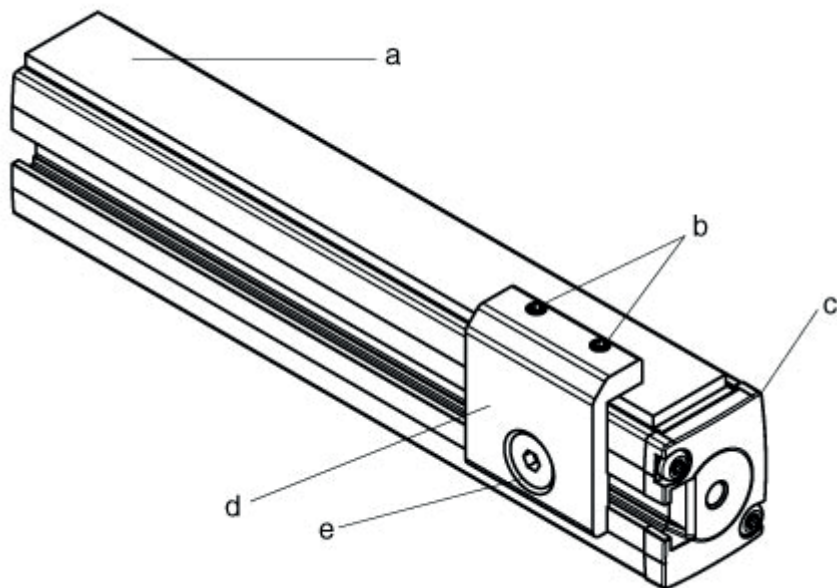

Notes

NOTE	
	⚠ The use of the protective screen reduces the range of the safety light curtain by approx. 10% per screen.

Accessories

Mounting technology - Mounting brackets

	Part no.	Designation	Article	Description
	429039 *	MLC-3PSF	Mounting bracket set	Type of fastening: Clampable Mounting device material: Metal

* Necessary accessories, please order separately

Note	
	⚠ A list with all available accessories can be found on the Leuze website in the Download tab of the article detailed page.