

## Technical data sheet

### Contour measurement system

Part no.: 50150257  
CMS748i-1120-1120-1200

#### Contents

- Set consists of
- Technical data
- Dimensioned drawings
- Electrical connection
- Diagrams
- Notes
- Accessories



For illustration purposes only



# Set consists of

	Quantity	Part no.	Designation	Article	Description
	6	424417	BT-2P40	Mounting bracket set	Contains: BT-P40 clamp bracket, 2x Bore hole 1: M6 Bore hole 2: M6 Design of mounting device: Mounting clamp Fastening, at system: Groove mounting Mounting bracket, at device: Groove mounting Type of mounting device: Clampable, Suitable for mounting in UDC-S2, DC-S2 device columns Material: Metal
	2	50118750	CML730i-R05-1120.A/L-M12	Light curtain receiver	Interface: IO-Link Connection: Connector, M12, Axial, 8 -pin
	1	50118751	CML730i-R05-1200.A/L-M12	Light curtain receiver	Interface: IO-Link Connection: Connector, M12, Axial, 8 -pin
	2	50118589	CML730i-T05-1120.A-M12	Light curtain transmitter	Operating range: 0.1 ... 4 m Connection: Connector, M12, Axial, 5 -pin
	1	50118590	CML730i-T05-1200.A-M12	Light curtain transmitter	Operating range: 0.1 ... 4 m Connection: Connector, M12, Axial, 5 -pin
	3	50129781	KDS DN-M12-5A-M12-5A-P3-050	Interconnection cable	Application: Oil and lubricant resistant Suitable for interface: DeviceNet, CANopen Connection 1: Connector, M12, Axial, Female, A-coded, 5 -pin Connection 2: Connector, M12, Axial, Male, A-coded, 5 -pin Shielded: Yes Cable length: 5,000 mm Sheathing material: PUR
	3	50135146	KDS S-M12-8A-M12-8A-P1-050	Interconnection cable	Application: Oil and lubricant resistant Connection 1: Connector, M12, Axial, Female, A-coded, 8 -pin Connection 2: Connector, M12, Axial, Male, A-coded, 8 -pin Shielded: Yes Cable length: 5,000 mm Sheathing material: PUR
	1	50142331	LSC748-000-100	Switch cabinet	Supply voltage: 100 ... 263 V, AC Switching inputs: 4 Piece(s) Switching outputs: 4 Piece(s) Connections: 13 Piece(s)

## Technical data

### Basic data

Series	CMS 7xxi
Contains	1x dongle CMS700
Order guide	Additional models on request

### Functions

Functions	For a minimum object height $\geq 50$ mm
-----------	--

### Optical data

Operating range	0.1 ... 4.5 m
Operating range, transparent media	0.1 ... 1.75 m
Operating range limit	0.1 ... 6 m
Measurement field length 1	1,120 mm
Measurement field length 2	1,120 mm
Measurement field length 3	1,200 mm
Beam spacing	5 mm

### Electrical data

Protective circuit	Polarity reversal protection
	Short circuit protected
	Transient protection

Output current, continuous current per channel, max.	100 mA
--	--------

#### Performance data

Supply voltage $U_B$	100 ... 263 V
Open-circuit current	250 mA

#### Inputs

Number of digital switching inputs	4 Piece(s)
------------------------------------	------------

#### Switching inputs

Type	Digital switching input
Voltage type	DC
Switching voltage	24 V, VIN

#### Outputs

Number of digital switching outputs	4 Piece(s)
-------------------------------------	------------

#### Switching outputs

Type	Digital switching output
Voltage type	AC
Switching voltage	24 V, VIN

### Interface

Type	EtherNet TCP/IP, PROFINET
------	---------------------------

#### Ethernet

Function	Configuration / process data
----------	------------------------------

#### PROFINET

Function	Configuration / process data
----------	------------------------------

### Connection

Number of connections	13 Piece(s)
-----------------------	-------------

#### Connection 1

Function	Earthing
Type of connection	Screw fitting
Material	Metal

#### Connection 2

Function	Voltage supply
Type of connection	Mains plug
Material	Metal

#### Connection 3

Function	External Ethernet TCP/IP connection
Type of connection	Connector
Thread size	M12
Type	Female
Material	Metal
No. of pins	4 -pin
Encoding	D-coded

#### Connection 4

Type of connection	Connector
Thread size	M12
Type	Female
Material	Metal
No. of pins	8 -pin
Encoding	A-coded

#### Connection 5

Function	Rotary encoder connection (not in combination with length measuring light curtain)
Type of connection	Connector
Thread size	M12
Type	Female
Material	Metal
No. of pins	8 -pin
Encoding	A-coded

#### Connection 6

Function	Digital switching input
Type of connection	Connector
Thread size	M12
Type	Female
Material	Metal
No. of pins	4 -pin
Encoding	A-coded

#### Connection 7

Function	Digital switching input
Type of connection	Connector
Thread size	M12
Type	Female
Material	Metal
No. of pins	4 -pin
Encoding	A-coded

#### Connection 8

Function	Digital switching output
Type of connection	Connector
Thread size	M12
Type	Female
Material	Metal
No. of pins	4 -pin
Encoding	A-coded

## Technical data

### Connection 9

Function	Digital switching output
Type of connection	Connector
Thread size	M12
Type	Female
Material	Metal
No. of pins	4 -pin
Encoding	A-coded

### Mechanical data

Design	Cubic
Housing material	Metal
Metal housing	Aluminum
Lens cover material	Plastic
Net weight	15,300 g
Housing color	Gray
	Red
Note	Dimensions of individual set items, see dimensioned drawings

### Operation and display

Type of display	LED
Number of LEDs	3 Piece(s)
Type of configuration	performed via webConfig
Operational controls	Rotary switch

### Environmental data

Ambient temperature, operation	0 ... 45 °C
Ambient temperature, storage	-20 ... 70 °C

### Certifications

Approvals	CSA
-----------	-----

### Classification

Customs tariff number	90314990
ECLASS 5.1.4	27270910
ECLASS 8.0	27270910
ECLASS 9.0	27270910
ECLASS 10.0	27270910
ECLASS 11.0	27270910
ECLASS 12.0	27270910
ECLASS 13.0	27270910
ECLASS 14.0	27270910
ECLASS 15.0	27270910
ECLASS 16.0	27270910
ETIM 5.0	EC002549
ETIM 6.0	EC002549
ETIM 7.0	EC002549
ETIM 8.0	EC002549
ETIM 9.0	EC002549
ETIM 10.0	EC002549
UNSPSC 26.08	39121528

## Dimensioned drawings

All dimensions in millimeters

### Light curtain transmitter and receiver

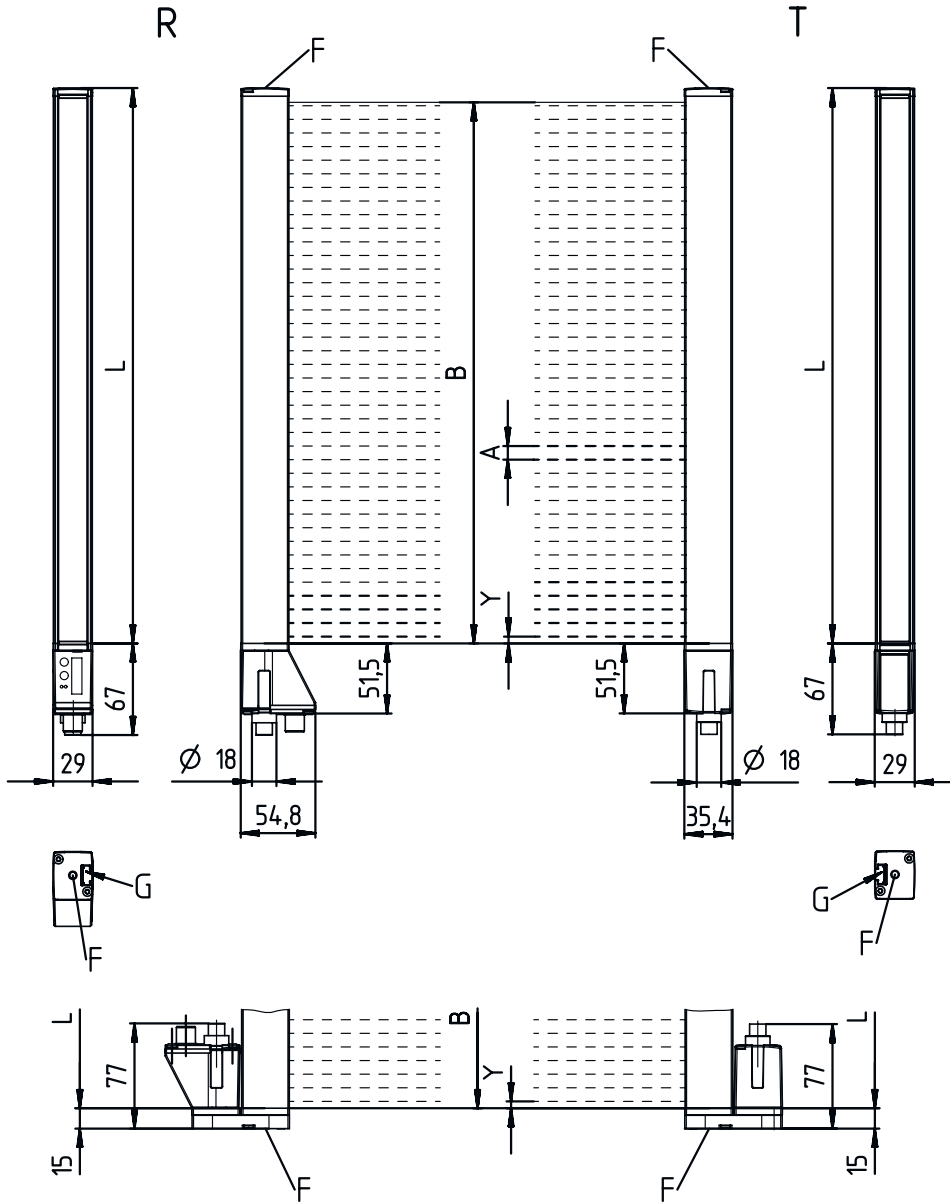

- |   |   |   |   |
|---|---|---|---|
| A | Beam spacing 5 mm   | L | Profile length 1 = 1,128 mm<br>Profile length 2 = 1,128 mm<br>Profile length 3 = 1,208 mm |
| B | Measurement field length 1 = 1,120 mm<br>Measurement field length 2 = 1,120 mm<br>Measurement field length 3 = 1,200 mm | T | Transmitter   |
| F | M6 thread   | R | Receiver  |
| G | Fastening groove  | Y | 2.5 mm  |

## Dimensioned drawings

### Switch cabinet



## Dimensioned drawings

### Switch cabinet connection diagram

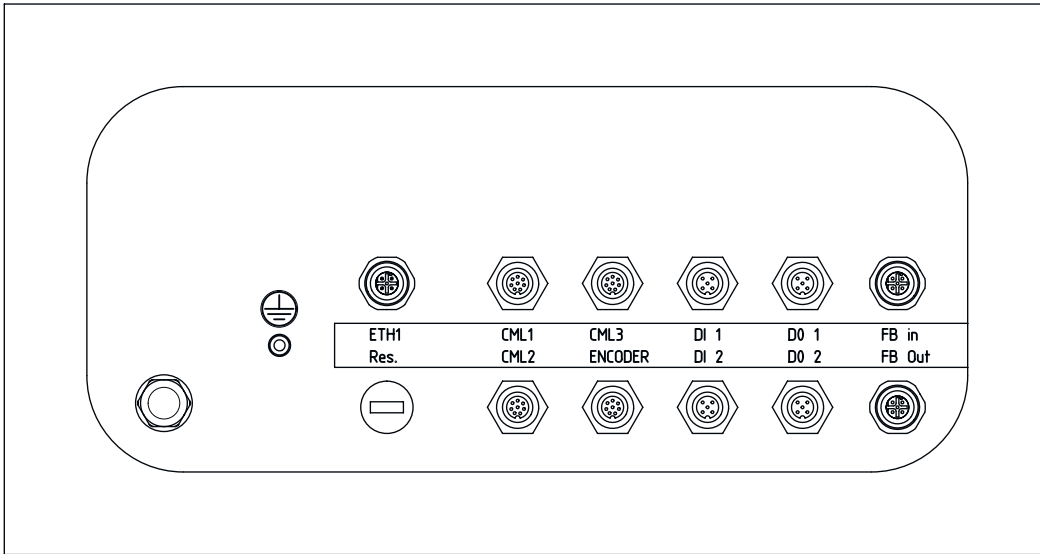

### Mounting bracket

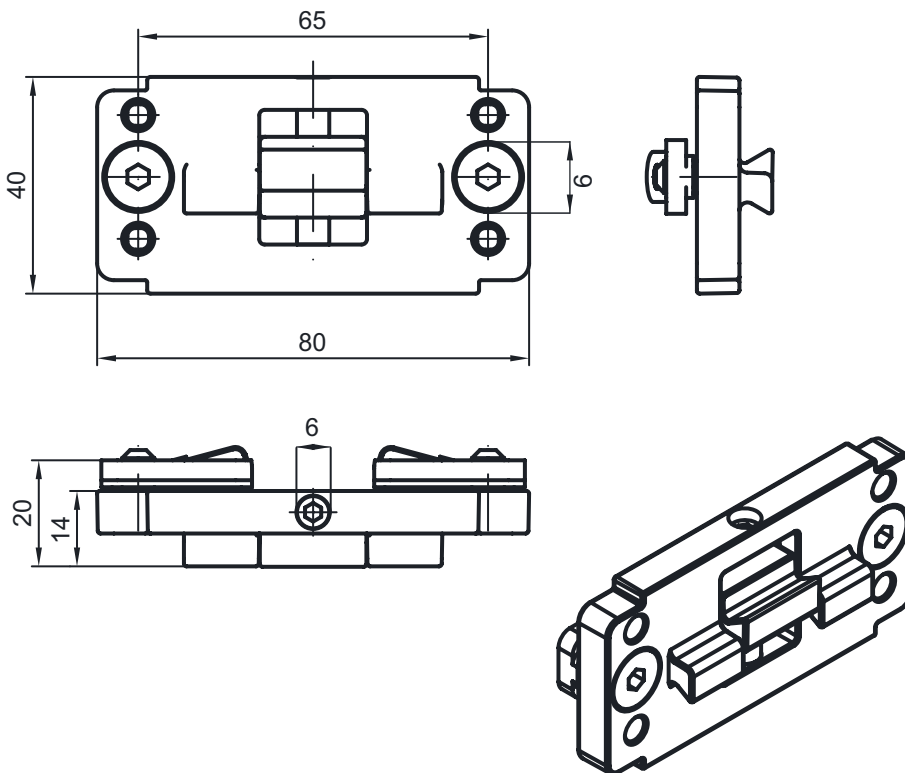

## Electrical connection

### Connection 1

Function	Earthing
Type of connection	Screw fitting
Material	Metal

### Connection 2

Function	Voltage supply
Type of connection	Mains plug
Material	Metal

### Connection 3

### ETH1

Function	External Ethernet TCP/IP connection
Type of connection	Connector
Thread size	M12
Type	Female
Material	Metal
No. of pins	4 -pin
Encoding	D-coded

### Pin Pin assignment

1	TD+
2	RD+
3	TD-
4	RD-



### Connection 4

### CML1 / CML2 / CML3

Type of connection	Connector
Type of connection	applicable for the connections CML1, CML2 and CML3
Thread size	M12
Type	Female
Material	Metal
No. of pins	8 -pin
Encoding	A-coded

### Pin Pin assignment

1	V+
2	IO1
3	GND
4	IO-Link
5	IO2
6	IO3
7	IO4
8	GND

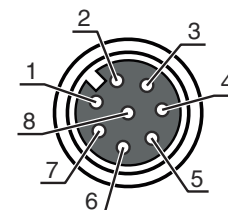

## Electrical connection

### Connection 5

### Encoder

Function	Rotary encoder connection (not in combination with length measuring light curtain)
Type of connection	Connector
Thread size	M12
Type	Female
Material	Metal
No. of pins	8 -pin
Encoding	A-coded

#### Pin Pin assignment

1	U-
2	U+
3	A
4	B
5	N
6	A inv.
7	B inv.
8	N inv.

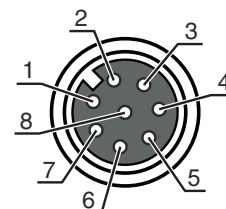

### Connection 6

### DI1

Function	Digital switching input
Type of connection	Connector
Thread size	M12
Type	Female
Material	Metal
No. of pins	4 -pin
Encoding	A-coded

#### Pin Pin assignment

1	+24 V
2	DI1
3	GND
4	DI2

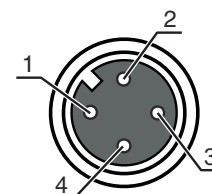

### Connection 7

### DI2

Function	Digital switching input
Type of connection	Connector
Thread size	M12
Type	Female
Material	Metal
No. of pins	4 -pin
Encoding	A-coded

#### Pin Pin assignment

1	+24 V
2	DI3
3	GND
4	DI4

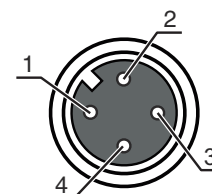

## Electrical connection

### Connection 8

### DO1

Function	Digital switching output
Type of connection	Connector
Thread size	M12
Type	Female
Material	Metal
No. of pins	4 -pin
Encoding	A-coded

Pin	Pin assignment
-----	----------------

1	+24 V
2	DO1
3	GND
4	DO2

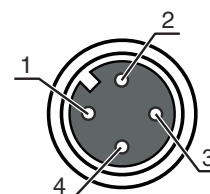

### Connection 9

### DO2

Function	Digital switching output
Type of connection	Connector
Thread size	M12
Type	Female
Material	Metal
No. of pins	4 -pin
Encoding	A-coded

Pin	Pin assignment
-----	----------------

1	+24 V
2	DO3
3	GND
4	DO4

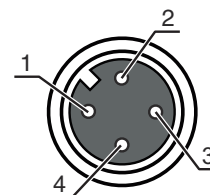

### Connection 10

### FB In

Function	PROFINET IN connection (optional)
Type of connection	Connector
Thread size	M12
Type	Female
Material	Metal
No. of pins	4 -pin
Encoding	D-coded

Pin	Pin assignment
-----	----------------

1	TD+
2	RD+
3	TD-
4	RD-

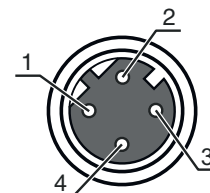

# Electrical connection

## Connection 11

## FB Out

Function	PROFINET OUT connection (optional)
Type of connection	Connector
Thread size	M12
Type	Female
Material	Metal
No. of pins	4 -pin
Encoding	D-coded

Pin	Pin assignment
1	TD+
2	RD+
3	TD-
4	RD-

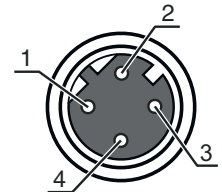

## Diagrams

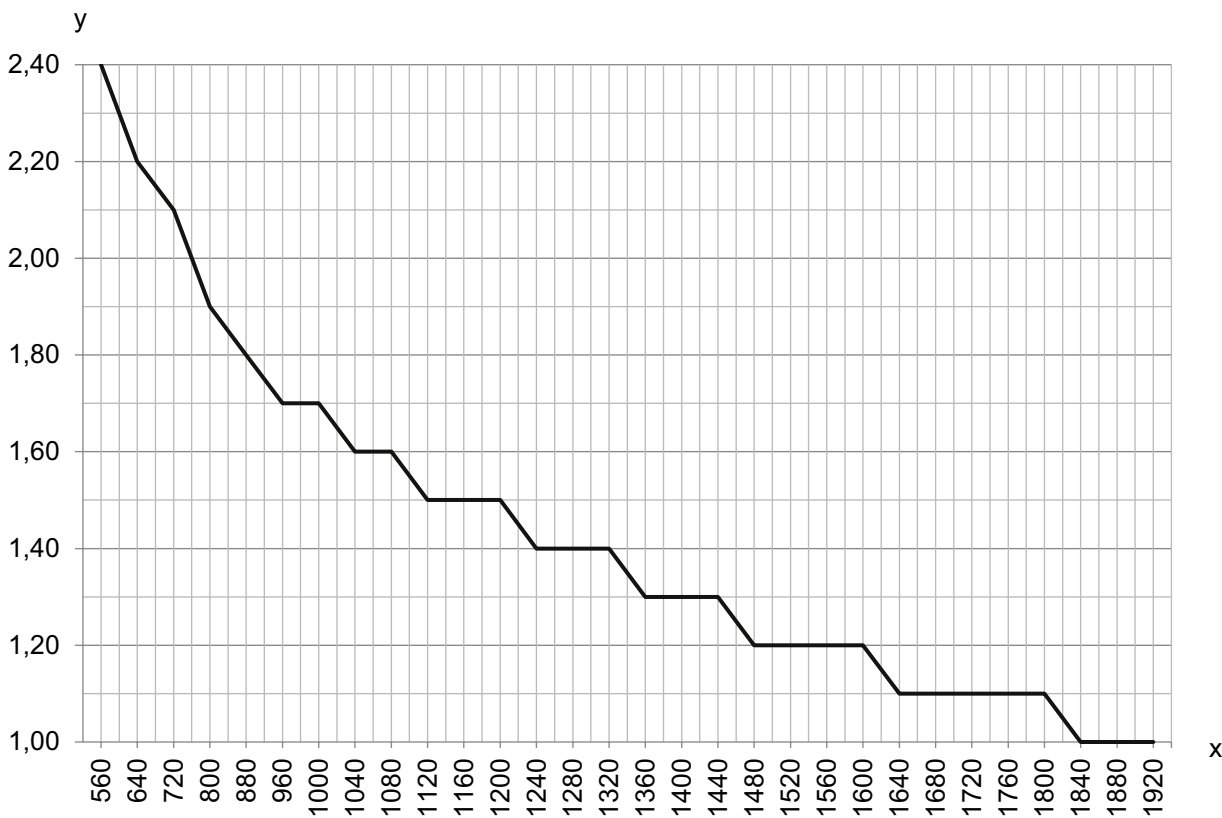

x Total measuring length from width and height measuring light curtain [mm]

y Max. conveyor speed [m/s]

## Notes



**Observe intended use!**





- ⚠ This product is not a safety sensor and is not intended as personnel protection.
- ⚠ The product may only be put into operation by competent persons.
- ⚠ Only use the product in accordance with its intended use.

## Accessories

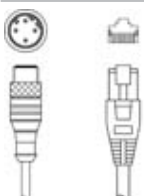
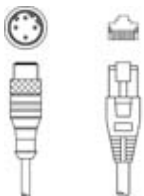
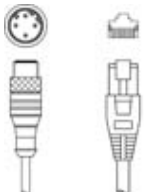
### Connection technology - Interconnection cables

	Part no.	Designation	Article	Description
	50135082	KSS ET-M12-4A-RJ45-A-P7-100	Interconnection cable	Application: Oil and lubricant resistant Suitable for interface: Ethernet Connection 1: Connector, M12, Axial, Male, D-coded, 4 -pin Connection 2: RJ45 Shielded: Yes Cable length: 10,000 mm Sheathing material: PUR
	50135083	KSS ET-M12-4A-RJ45-A-P7-150	Interconnection cable	Application: Oil and lubricant resistant Suitable for interface: Ethernet Connection 1: Connector, M12, Axial, Male, D-coded, 4 -pin Connection 2: RJ45 Shielded: Yes Cable length: 15,000 mm Sheathing material: PUR
	50135084	KSS ET-M12-4A-RJ45-A-P7-300	Interconnection cable	Application: Oil and lubricant resistant Suitable for interface: Ethernet Connection 1: Connector, M12, Axial, Male, D-coded, 4 -pin Connection 2: RJ45 Shielded: Yes Cable length: 30,000 mm Sheathing material: PUR

### Mounting technology - Other

	Part no.	Designation	Article	Description
	50143670	BT 708M-MRSET	Mounting device set	Contains: Mounting material, Mounting profiles Design of mounting device: Profile kit Fastening, at system: Screw type / vertical Mounting bracket, at device: Groove mounting Type of mounting device: Rigid Material: Aluminum Shock absorber: No
	50143669	BT 710M-MRSET	Mounting device set	Contains: Mounting profiles, Mounting material Design of mounting device: Profile kit Fastening, at system: Screw type / vertical Mounting bracket, at device: Groove mounting Type of mounting device: Rigid Material: Aluminum Shock absorber: No

**Accessories**

	<b>Part no.</b>	<b>Designation</b>	<b>Article</b>	<b>Description</b>
	50142039	BT 712M-MRSET	Mounting device set	Contains: Mounting profiles, Mounting material Design of mounting device: Profile kit Fastening, at system: Screw type / vertical Mounting bracket, at device: Groove mounting Type of mounting device: Rigid Material: Aluminum Shock absorber: No

**Note**

A list with all available accessories can be found on the Leuze website in the Download tab of the article detailed page.