

Translation of original operating instructions

RSL 311 Safety Laser Scanner



© 2024

Leuze electronic GmbH + Co. KG

In der Braike 1

73277 Owen / Germany

Phone: +49 7021 573-0

Fax: +49 7021 573-199

www.leuze.com

info@leuze.com

1	About this document	6
1.1	Other applicable documents	6
1.2	Downloading the configuration and diagnostic software from the Internet	6
1.3	Used symbols and signal words	6
1.4	Checklists.....	7
2	Safety	8
2.1	Intended use	8
2.1.1	Vapors, smoke, dust, particles	9
2.1.2	Stray light.....	9
2.1.3	Obstructions in the protective field	9
2.2	Foreseeable misuse.....	10
2.3	Competent persons.....	10
2.4	Disclaimer	11
2.5	Laser safety notices	11
2.6	Responsibility for safety	11
3	Device description	12
3.1	Device overview	12
3.1.1	Protective function of RSL 300 safety sensors.....	13
3.1.2	Parameters for protective function.....	13
3.2	Connection unit	14
3.3	Display elements.....	15
3.3.1	LED indicator	15
3.3.2	Alphanumerical display.....	16
3.3.3	Field-of-view display	17
3.4	Mounting system (optional).....	17
3.5	Loop guard (optional).....	17
4	Configuration and diagnostic software Sensor Studio	18
4.1	System requirements	18
4.2	Installing software	18
4.3	User interface.....	20
4.4	FDT frame menu	21
4.4.1	Project wizard	21
4.4.2	DTM change	22
4.4.3	User management.....	22
4.4.4	Exiting Sensor Studio	22
4.5	Using configuration projects.....	23
4.5.1	Selecting access level	25
4.5.2	IDENTIFICATION.....	25
4.5.3	PROCESS	26
4.5.4	CONFIGURATION	26
4.5.5	DIAGNOSIS.....	26
4.5.6	SETTINGS.....	27
5	Functions.....	29
5.1	Authorization concept of safety sensor	29
5.2	Function modes of safety sensor	30
5.2.1	One protective function.....	31
5.2.2	One protective function – four field mode.....	31
5.3	Selectable resolution for hand, leg and body detection	32
5.4	Speed-dependent protective function for vehicles	32

5.5	Response time	32
5.6	Configurable start-up behavior.....	32
5.6.1	Automatic start/restart	32
5.6.2	Start interlock/automatic restart.....	33
5.6.3	Start/restart interlock (RES).....	33
5.7	Reference contour monitoring.....	34
5.8	EDM contactor monitoring	34
5.9	Expanded shock monitoring.....	35
6	Applications	36
6.1	Stationary danger zone guarding.....	36
6.2	Stationary point of operation guarding	36
6.3	Stationary access guarding.....	37
6.4	Mobile danger zone guarding	38
6.5	Danger zone safeguarding on side-tracking skates	40
7	Mounting.....	41
7.1	Basic infos.....	41
7.1.1	Calculation of safety distance S	41
7.1.2	Suitable mounting locations.....	42
7.1.3	Mounting the safety sensor	42
7.1.4	Mounting examples	45
7.1.5	Information on protective field dimensioning	46
7.2	Stationary danger zone guarding.....	49
7.3	Stationary point of operation guarding	52
7.4	Stationary access guarding.....	53
7.5	Mobile danger zone guarding on AGVs	55
7.5.1	Minimum distance D.....	55
7.5.2	Protective field dimensions.....	57
7.6	Mobile side guarding on AGVs	58
7.7	Mounting accessories	58
7.7.1	Mounting system	58
7.7.2	Loop guard	59
8	Electrical connection.....	60
8.1	Electrical supply	61
8.2	Interfaces	61
8.2.1	Pin assignment for control M12.....	62
8.2.2	Pin assignment of M12 Ethernet interface (communication) (D-coded).....	63
8.3	Connection unit CU308-M12.....	63
8.4	Cable lengths according to the supply voltage	65
8.5	Circuit diagram example	66
9	Configuring the safety sensor	67
9.1	Defining safety configuration.....	67
9.2	Connecting safety sensor to PC	69
9.2.1	Connection via Ethernet cable.....	69
9.2.2	Communication between safety sensor and PC	69
9.3	Determine the configuration project	69
9.4	Configuring protective function	71
9.4.1	Creating simple safety configuration	71
9.4.2	Entering administration parameters.....	71
9.4.3	Activating protective function and contactor monitoring	71

9.4.4	Creating and configuring protective/warning field pairs.....	72
9.5	Configuring expanded shock monitoring.....	74
9.6	Saving configuration	74
9.7	Transferring configuration project to safety sensor.....	75
9.8	Selecting access level.....	77
9.9	Reset safety configuration	77
10	Starting up the device	78
10.1	Switching on.....	78
10.2	Aligning the safety sensor.....	78
10.3	Unlocking start/restart interlock.....	78
10.4	Shutting down	79
10.5	Restarting.....	79
10.6	Starting up replacement scanner unit	79
11	Testing	81
11.1	Before the initial start-up and following modifications	81
11.1.1	Checklist for integrator – to be performed prior to the initial start-up and following modifications	81
11.2	To be performed periodically by competent persons	83
11.3	Periodically by the operator	83
11.3.1	Checklist – periodically by the operator.....	84
12	Diagnosis and troubleshooting.....	85
12.1	What to do in case of failure?	85
12.2	Diagnostics displays	85
13	Care, maintenance and disposal	89
13.1	Changing scanner unit.....	89
13.2	Cleaning the optics cover.....	90
13.3	Servicing	91
13.4	Disposing	91
14	Service and support	92
15	Technical data	93
15.1	General specifications.....	93
15.2	Dimensions	97
15.3	Dimensioned drawings: Accessories	99
15.4	Representation of safety sensor status.....	107
16	Standards and legal regulations	110
17	Order guide and accessories.....	111
17.1	Type overview.....	111
17.2	Accessories – connection technology.....	111
17.3	Accessories – mounting systems.....	112
17.4	Accessories – cleaning sets.....	112
18	EC Declaration of Conformity	113

1 About this document

1.1 Other applicable documents

The information on the safety sensor is distributed over several documents to make working with the documents easier. You will find the documents and software for the safety sensor in the following table:

Purpose and target group of the document	Document/software title	Source
Software for users of the machine ^{a)} for safety sensor diagnostics if a fault occurs and for machine design engineers for configuring the safety sensor	Sensor Studio DTM RSL 400	Available for download from the product page of the device at www.leuze.com
Notes for the machine design engineer ^{a)}	Operating instructions of the safety sensor (this document)	
Notes for the machine design engineer ^{a)} for configuring the safety sensor (software instructions)	Online help for software	



a) Machine identifies the product that the safety sensor is installed in.

1.2 Downloading the configuration and diagnostic software from the Internet



- ↳ Call up the Leuze website: www.leuze.com.
- ↳ Enter the type designation or part number of the device as the search term.
- ↳ The configuration and diagnostic software can be found on the product page for the device under the Downloads tab.

1.3 Used symbols and signal words

Tab. 1.1: Warning symbols and signal words

	Symbol indicating dangers to persons
	Symbol indicating dangers from harmful laser radiation
	Symbol indicating possible property damage
NOTE	Signal word for property damage Indicates dangers that may result in property damage if the measures for danger avoidance are not followed.
CAUTION	Signal word for minor injuries Indicates dangers that may result in minor injury if the measures for danger avoidance are not followed.
WARNING	Signal word for serious injury Indicates dangers that may result in severe or fatal injury if the measures for danger avoidance are not followed.
DANGER	Signal word for life-threatening danger Indicates dangers with which serious or fatal injury is imminent if the measures for danger avoidance are not followed.

Tab. 1.2: Other symbols

	Symbol for tips Text passages with this symbol provide you with further information.
	Symbol for action steps Text passages with this symbol instruct you to perform actions.
	Symbol for action results Text passages with this symbol describe the result of the preceding action.

Tab. 1.3: Terms and abbreviations

CS	Switching signal from a control (C ontroller S ignal)
DTM	Software device manager of the safety sensor (D evice T ype M anager)
EDM	Contacting monitoring (E xternal D evice M onitoring)
FDT	Software frame for management of device managers (DTM) (F ield D evice T ool)
Field pair	A protective field with an associated warning field
AGV	A utomated G uided V ehicle
LED	LED, display element in the safety sensor (L ight E mitting D iode)
OSSD	Safety-related switching output (O utput S ignal S witching D evice)
PELV	Protective extra-low voltage (P rotective E xtra L ow V oltage)
PFH _d	Probability of a dangerous failure per hour (P robability of dangerous F ailure per H our)
PL	P erformance L evel
Quad	Two field pairs (four fields) that are monitored simultaneously in four field mode
TSS	T ransverse S ide-tracking S kate
RES	Start/restart interlock (Start/ RE start interlock)
SIL	S afety I ntegrity L evel
State	ON: device intact, OSSDs switched on OFF: device intact, OSSDs switched off Locking: device, connection or actuation/operation faulty, OSSDs switched off (lock-out)

1.4 Checklists

The checklists serve as a reference for the machine manufacturer or supplier (see chapter 11 "Testing"). They replace neither testing of the complete machine or system prior to the initial start-up nor their periodic testing by a competent person. The checklists contain minimum testing requirements. Depending on the application, other tests may be necessary.

2 Safety

Before using the safety sensor, a risk assessment must be performed according to valid standards (e.g. EN ISO 12100, EN ISO 13849-1, IEC/EN 61508, EN IEC 62061). The result of the risk assessment determines the required safety level of the safety sensor (see chapter 15.1 "Safety-relevant technical data"). For mounting, operating and testing, this document as well as all applicable national and international standards, regulations, rules and directives must be observed. Relevant and supplied documents must be observed, printed out and handed to affected persons.

↳ Before working with the safety sensor, completely read and observe the documents applicable to your task.



In particular, the current version of the following national and international legal regulations apply for commissioning, technical tests and handling of safety sensors:

- Machinery Directive
- Low Voltage Directive
- Electromagnetic Compatibility Directive
- Use of Work Equipment Directive
- Directive on the restriction of the use of certain hazardous substances in electrical and electronic equipment
- OSHA
- Safety regulations
- Accident-prevention regulations and safety rules
- Ordinance on Industrial Safety and Health and employment protection act
- Product Safety Law (ProdSG)

NOTICE	
	For safety-related information you may also contact local authorities (e.g., industrial inspectorate, employer's liability insurance association, labor inspectorate, occupational safety and health authority).



2.1 Intended use

The safety sensor protects persons or body parts at points of operation, danger zones or access points of machines and systems.

 WARNING	
	<p>A running machine may result in serious injury!</p> <p>↳ Make certain that the safety sensor is correctly connected and that the protective function of the protective device is ensured.</p> <p>↳ Make certain that, during all conversions, maintenance work and inspections, the system is securely shut down and protected against being restarted.</p>

- The safety sensor may only be used after it has been selected in accordance with the respectively applicable instructions and relevant standards, rules and regulations regarding labor protection and safety at work, and after it has been installed on the machine, connected, commissioned, and checked by a competent person (see chapter 2.3 "Competent persons").
- When selecting the safety sensor it must be ensured that its safety-related capability meets or exceeds the required Performance Level PL, ascertained in the risk assessment (see chapter 15.1 "Safety-relevant technical data").
- The safety sensor may only be used in North America in applications that satisfy the requirements specified by NFPA 79.
- With the "access guarding" function, the safety sensor detects persons only when they enter the danger zone but cannot tell whether there are any persons inside the danger zone. For this reason, a start/restart interlock in the safety chain is essential in this case.
- The construction of the safety sensor must not be altered. When manipulating the safety sensor, the protective function is no longer guaranteed. Manipulating the safety sensor also voids all warranty claims against the manufacturer of the safety sensor.

- The safety sensor must be inspected regularly by a competent person to ensure proper integration and mounting (see chapter 15.1 "Safety-relevant technical data").

 CAUTION	
	<p>Observe intended use!</p> <p>The protection of personnel and the device cannot be guaranteed if the device is operated in a manner not complying with its intended use.</p> <ul style="list-style-type: none"> ↪ Only operate the device in accordance with its intended use. ↪ Leuze electronic GmbH + Co. KG is not liable for damages caused by improper use. ↪ Read these operating instructions before commissioning the device. Knowledge of the operating instructions is an element of proper use.
NOTICE	
	<p>Comply with conditions and regulations!</p> <ul style="list-style-type: none"> ↪ Observe the locally applicable legal regulations and the rules of the employer's liability insurance association.

2.1.1 Vapors, smoke, dust, particles

Vapors, smoke, dust and all particles visible in the air can cause the machine to switch off unintentionally. This can mislead the user into bypassing the safety devices.

- ↪ Do not use the safety sensor in environments in which heavy vapors, smoke, dust or other visible particles occur at the scan level.

2.1.2 Stray light

Light sources can impair the safety sensor's availability. Interfering light sources are:

- Infrared light
- Fluorescent light
- Strobe light

- ↪ Ensure that there are no interfering light sources at scan level.
- ↪ Prevent reflective surfaces at scan level.
- ↪ Where applicable, take protective field addition distances into account.
- ↪ Implement all additional measures to ensure that any special application of any effected beam types does not impair the safety sensor's operation.

2.1.3 Obstructions in the protective field

- ↪ Do not bring any additional window materials into the area monitored by the safety sensor.

NOTICE	
	<p>No screen between optics cover and monitoring area!</p> <ul style="list-style-type: none"> ↪ Between the optics cover of the safety sensor and the monitored area, no further screen may be mounted to protect the safety sensor.

2.2 Foreseeable misuse

Any use other than that defined under "Intended use" or which goes beyond that use is considered improper use.

In principle, the safety sensor is **not** suitable as a protective device for use in the following cases:

- Danger posed by ejected objects or the spraying of hot or hazardous liquids from within the danger zone.
- Applications in explosive or easily flammable atmospheres.
- Use for outdoor applications or under extreme temperature fluctuations.
Humidity, condensation and other weather influences can impair the protective function.
- Use on vehicles with combustion engines.
Alternators and ignition systems can cause EMC interferences.

NOTICE	
	<p>Do not modify or otherwise interfere with the safety sensor!</p> <ul style="list-style-type: none"> ↳ Do not carry out modifications or otherwise interfere with the safety sensor. The safety sensor must not be tampered with and must not be changed in any way. ↳ The safety sensor must not be opened. There are no user-serviceable parts inside. ↳ The construction of the safety sensor must not be altered. When manipulating the safety sensor, the protective function is no longer guaranteed. ↳ Manipulating the safety sensor voids all warranty claims against the manufacturer of the safety sensor. ↳ Repairs must only be performed by Leuze electronic GmbH + Co. KG.

2.3 Competent persons

Connecting, mounting, commissioning and adjustment of the safety sensor must only be carried out by competent persons.

Prerequisites for competent persons:

- They have a suitable technical education.
- They know the rules and regulations for labor protection, safety at work and safety technology and can assess the safety of the machine.
- They know the operating instructions for the safety sensor and the machine.
- They have been instructed by the responsible person on the mounting and operation of the machine and of the safety sensor.
- They perform a task related to the subject matter shortly thereafter and keep their knowledge up to date through continuous further training.

Certified electricians

Electrical work must be carried out by a certified electrician.

Due to their technical training, knowledge and experience as well as their familiarity with relevant standards and regulations, certified electricians are able to perform work on electrical systems and independently detect possible dangers.

In Germany, certified electricians must fulfill the requirements of accident-prevention regulations DGUV (German Social Accident Insurance) provision 3 (e.g. electrician foreman). In other countries, there are respective regulations that must be observed.



2.4 Disclaimer

Leuze electronic GmbH + Co. KG is not liable in the following cases:

- The safety sensor is not used as intended.
- Safety notices are not adhered to.
- Reasonably foreseeable misuse is not taken into account.
- Mounting and electrical connection are not properly performed.
- Proper function is not tested (see chapter 11 "Testing").
- Changes (e.g., constructional) are made to the safety sensor.

2.5 Laser safety notices

Laser class 1 for wavelength range outside 400 - 700 nm

NOTICE	
	Additional measures for shielding the laser radiation are not necessary (safe for eyes).
 ATTENTION	
	<p>LASER RADIATION – CLASS 1 LASER PRODUCT</p> <p>The device satisfies the requirements of IEC 60825-1:2014 / EN 60825-1:2014+A11:2021 safety regulations for a product of laser class 1 and complies with 21 CFR 1040.10 except for conformance with IEC 60825-1 Ed. 3., as described in Laser Notice No. 56, dated May 8, 2019.</p> <ul style="list-style-type: none"> ↳ Observe the applicable statutory and local laser protection regulations. ↳ The device must not be tampered with and must not be changed in any way. There are no user-serviceable parts inside the device. <p>CAUTION! Opening the device may result in hazardous radiation exposure! Repairs must only be performed by Leuze electronic GmbH + Co. KG.</p>

2.6 Responsibility for safety

Manufacturer and operator must ensure that the machine and implemented safety sensor function properly and that all affected persons are adequately informed and trained.

The type and content of all imparted information must not lead to unsafe actions by users.

The manufacturer of the machine is responsible for:

- Safe machine construction and information on any residual risks
- Safe implementation of the safety sensor, verified by the initial test performed by a competent person
- Imparting all relevant information to the operating company
- Adhering to all regulations and directives for the safe commissioning of the machine

The operator of the machine is responsible for:

- Instructing the operator
- Maintaining the safe operation of the machine
- Adhering to all regulations and directives for labor protection and safety at work
- Regular testing by competent persons

3 Device description

The safety sensors from the RSL 300 series are optoelectronic, two-dimensional measuring safety laser scanners. They satisfy the following standards:

	RSL 300
Type in accordance with EN IEC 61496	3
Category in accordance with EN ISO 13849-1:2015	3
Safety Integrity Level (SIL) in accordance with IEC/EN 61508	2
Maximum SIL in accordance with EN IEC 62061	2
Performance Level (PL) in accordance with EN ISO 13849-1:2015	d

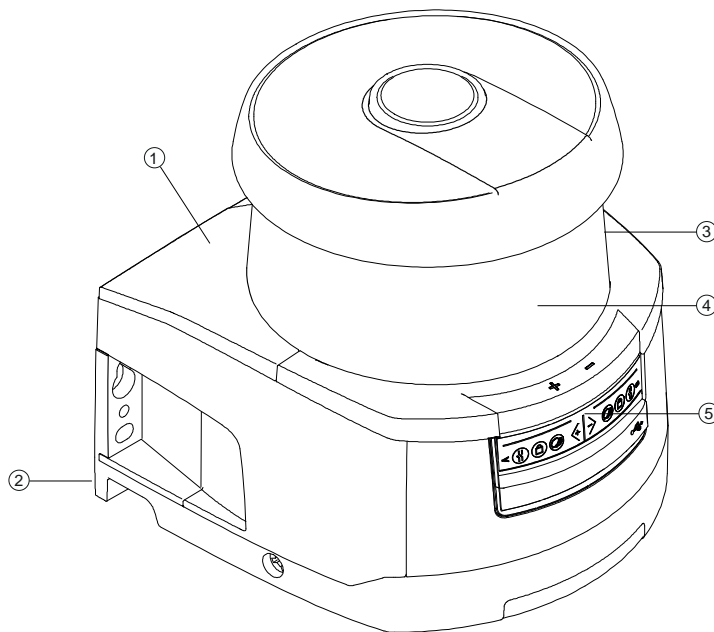

- 1 Scanner unit
- 2 Connection unit
- 3 Optics cover
- 4 Alphanumerical display (displayed)
- 5 LED indicators

Fig. 3.1: Device overview of RSL 300 safety laser scanners

All safety sensors of the RSL 311 series are equipped as follows:

- Laser scanner with the range class **S**:

Operating range class	Operating range [m]
S	3.00

- 24-digit alphanumerical display
- Integrated electronic spirit level for aligning the safety sensor
- LED indicator
- Connection unit:
 - Configuration memory
 - Ethernet connection for communication and configuration with the PC/laptop
 - Electrical connection to the machine via M12 plug

3.1 Device overview

The following table provides an overview of the possible uses, features and functions of the RSL 300 safety sensors.

Tab. 3.1: Device overview

	RSL 311
Stationary danger zone guarding	x
Mobile danger zone guarding	x
Access guarding	x
Point of operation guarding	x
Safety-related switching outputs	1 OSSD pair
Protective function A	x
Protective function B	-
Signal outputs	Up to 3
Configurable signal outputs	x
Number of switchable protective/warning field pairs	1
E-stop linkage	-
Four field mode (quads)	x
Internal safe time delay	-
Measurement data output optimized for vehicle navigation	-
USB interface	-
Bluetooth interface	-

3.1.1 Protective function of RSL 300 safety sensors

The safety sensor transmits periodic light pulses via a rotating deflection unit. The light pulses are scattered in all directions by obstacles, e.g. persons. A part of the light pulses is received again by the safety sensor and evaluated. The safety sensor calculates the precise position of the object from the propagation time of the radiated light and the current angle of the deflection unit at that time. If the object is within a predefined area, the protective field, the safety sensor performs a safety-related switching function. It switches the safety-related switching outputs off.

Only when the protective field is free again does the safety sensor reset the safety-related switching function, either automatically or following acknowledgment, depending on the operating mode.

The safety sensor can even detect people when they are wearing very dark clothes, which have a very weak diffuse reflectance.

3.1.2 Parameters for protective function

The following parameters for switching off the safety-related switching outputs of the safety sensor are taken into consideration for the protective function:

- Configurable protective fields
- Reference contour of protective fields
- Configurable field pair changeover
- Selectable resolution for hand, leg or body detection
- Safety sensor response time
- Selectable start-up behavior

The following non-safety-oriented functions and signals also belong to the protective function:

- Configurable warning fields
- Configurable indication signals

Additional functions of the protective function

- Warning field evaluation
- Selectable dynamic contactor monitoring (EDM)

3.2 Connection unit

The safety sensor is mounted, connected and aligned using the connection unit.

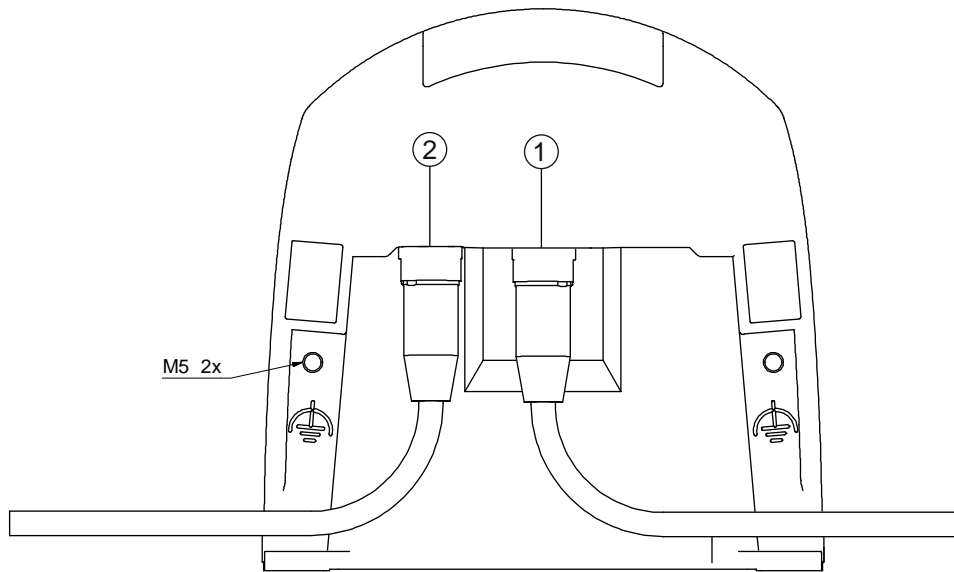

- 1 M12 socket, A-coded, connection to the control
- 2 M12 socket, D-coded, Ethernet communication connection
- M5 Connection for functional earth with M5 x 10 self-cutting/self-tapping (gas tightness) and ground strap

Fig. 3.2: Device overview, connection unit

Functions of connection unit:

- Attachment point for mounting, either directly or using an optional mounting system. When devices are swapped out, the connection unit remains mounted and aligned.
- EMC wiring for signal inputs/outputs and supply using M12 plug

Safety sensor	Connection unit	Connection
RSL 311	CU308-M12	M12 connector, 8-pin

- Connector bushing and EMC for the Ethernet TCP/IP communication and configuration interface to the PC/laptop
- Memory for the configuration files and automatic parameter transfer in the event of device swap-out
- Quick-release connection to the scanner unit for easy device swap-out

NOTICE



To ensure the IP protection and leak tightness of the devices, the supplied protection caps must always be placed on unused connections.

3.3 Display elements

The display elements of the safety sensors simplify start-up and fault analysis.

3.3.1 LED indicator

Located on the connection unit are six LEDs for displaying the operating state.

- Protective function A: LEDs 1, 2, 3

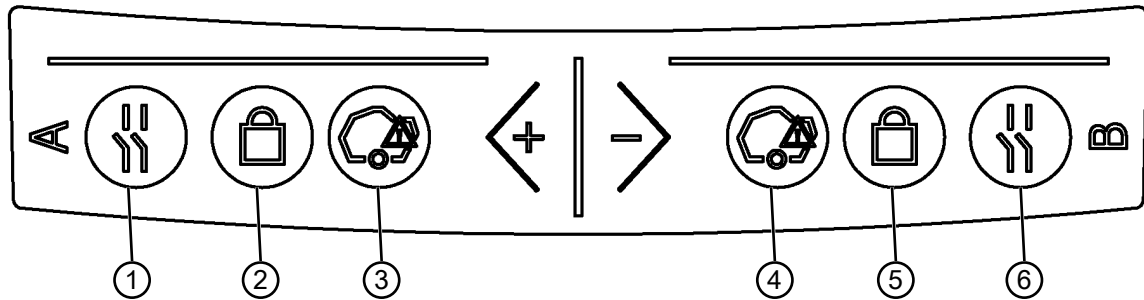

- 1 LED 1, red/green
- 2 LED 2, yellow
- 3 LED 3, blue
- 4 LED 4, blue
- 5 LED 5, yellow
- 6 LED 6, red/green

Fig. 3.3: LED indicators

Tab. 3.2: Meaning of the LEDs

LED	Color	State	Description
1	Red/green	OFF	Device switched off
		Red	OSSD off
		Red, flashing	Error
		Green	OSSD on
2	Yellow	OFF	RES deactivated RES activated and enabled
		Flashing	Protective field occupied
		ON	RES activated and blocked but ready to be unlocked Protective field free and linked sensor enabled (if applicable)
3	Blue	OFF	Free warning field
		ON	Warning field interrupted
4	Blue	OFF	Four field mode: warning field 3 free
		ON	Four field mode: warning field 3 interrupted
5	Yellow	Flashing	Four field mode: warning field 2 interrupted
6	Red	Flashing	Error

3.3.2 Alphanumerical display

In normal operation, the 24-digit alphanumerical display of the safety sensor shows the monitored protective and warning field pairs. It also provides assistance during detailed error diagnostics (see chapter 12 "Diagnosis and troubleshooting").

Tab. 3.3: Alphanumerical displays

Display	Description	Example
Upon startup without configuration/upon initial commissioning		
Sensor type	Sensor type	311S
Software version	Software version of the device	V5.6
Sensor serial number	Sensor serial number	SN: 21513123456
Sensor name / Network name	Name of the sensor / network	A123456789
IP: DHCP/FIX	DHCP or permanent IP address	IP: DHCP IP: 10.25.45.2
Bluetooth on/off	Bluetooth detection ON/OFF	NO Bluetooth
Configuration necessary	Configuration required	CONFIG REQUESTED
<i>Repeated until end of booting phase / start phase, then</i>		
Spirit level permanent	Horizontal alignment in degrees: H Vertical alignment in degrees: V	H -3° V +9°
Upon startup with configuration		
Sensor type	Sensor type	311S
Software version	Software version of the device	V5.6
Sensor serial number	Sensor serial number	SN: 21513123456
Sensor name / Network name	Name of the sensor / network	A123456789
IP: DHCP/FIX	DHCP or permanent IP address	IP: DHCP IP: 10.25.45.2
Bluetooth on/off	Bluetooth detection ON/OFF	NO Bluetooth
Date of configuration	Date of configuration	11/13/2014 08:15
Signature	Signature of configuration	DG45L8ZU
Level	Horizontal alignment in degrees: H Vertical alignment in degrees: V	H -3° V +9°
<i>Repeated until end of booting phase / start phase, then</i>		
Display following configuration of normal operation e.g. display of active field pair		A1.1
Transfer of the configuration data		
AWAITING CONFIG	Until downloading of configuration data is confirmed	
DOWNLOAD CONFIG	During transfer of configuration data	
Level		
H +/-..° V +/-..°	Horizontal alignment in degrees: H Vertical alignment in degrees: V	H -3° V +9°
Sensor detection		
PING received	Display for identification by device name	PING received <i>Device name</i>

Display	Description	Example
Message		
	Message via a signal output or diagnosis ID	ProtF A: E123 Device: P007 - wrong Config
Error diagnostics		
F...	Failure, internal device error	
E...	Error, external error	
U...	Usage info, application error	
I...	Information	
P...	Parameter, inconsistency in the configuration	

For error diagnostics, the error's respective letter is displayed first followed by the number code. An AutoReset is carried out after 10 seconds for errors that do not cause locking, with an unauthorized restart being impossible. In the case of blocking errors, the voltage supply must be separated and the cause of the error must be eliminated. Before switching on again, the steps taken before initial commissioning must be repeated (see chapter 10 "Starting up the device").

When the protective field has been free for about 5 seconds, the device switches back to the display in normal operation.

Displays in normal operation

The display in normal operation depends on the operating state of the safety sensor. The display can be switched off or rotated by 180° by means of the software.

3.3.3 Field-of-view display

The upper and lower limit of the safety sensor's field of view can be displayed by means of horizontal lines on the optics cover.

⚡ Make sure that the safety sensor's field of view is always completely unobstructed.

NOTICE	
	<p>Always check the protective field configuration!</p> <ul style="list-style-type: none"> ⚡ Check all defined protective fields each time the configuration is changed. The field-of-view display is a comfort function and is not intended as a substitute for checking the protective field configuration. ⚡ The safety sensor's field of view must be completely unobstructed on the application side.

3.4 Mounting system (optional)

Mounting systems and mounting brackets simplify mounting and alignment of the safety sensor. Mounting systems and mounting brackets are available as accessories (see chapter 17 "Order guide and accessories").

3.5 Loop guard (optional)

The loop guard for the optics cover prevents damage to the safety sensor caused by light contact with foreign objects. The loop guard is available as an accessory (see chapter 17 "Order guide and accessories").

4 Configuration and diagnostic software Sensor Studio

To start up a safety sensor in your application, the safety sensor must be set up according to its specific use using the configuration and diagnostic software. The software is used to set up the safety configuration of the safety sensor, to change the communication and diagnostics settings and to perform diagnostic routines. Communication takes place via the PC.

The software is designed according to the FDT/DTM concept:

- You make the individual configurations for the safety sensor in the Device Type Manager (DTM).
- The individual DTM configurations of a project can be called up via the frame application of the Field Device Tool (FDT).
- Each device DTM has a communication DTM that sets up and monitors the communication connections to the sensor.

NOTICE	
	Only use the software for safety sensors manufactured by Leuze .

4.1 System requirements

To use the software, you need a PC or laptop with the following specifications:

Hard disk space	At least 250 MB free memory If you want to save the protective field or configuration values, you will need more memory.
Screen display	Color
Input device	Keyboard and mouse or touchpad
Output device	Printer (black-white or color)
Interfaces	RJ45 Ethernet network
Operating system	Microsoft® Windows 7 or higher

NOTICE	
	Only the term "PC" is used below.

4.2 Installing software

Prerequisites:

- You do **not** need the safety sensor to install the software on the PC.
- All Windows applications are closed.

NOTICE	
	The software is installed in two steps: <ul style="list-style-type: none"> ↳ Installing the <i>Sensor Studio</i> FDT frame. ↳ Installing the device manager (DTM) <i>Safety Device Collection</i>.

Installing the Sensor Studio software

NOTICE	
	<p>If FDT frame software is already installed on your PC, you do not need the <i>Sensor Studio</i> installation.</p> <p>You can install the device manager (DTM) in the existing FDT frame.</p>

- ↵ Download the zip file of the configuration and diagnostic software *SW_setup_sensorStudio.zip* from the Leuze website.
- ↵ Unzip the file.
- ↵ Double-click the file *Setup_SensorStudio.exe*.
- ↵ Select a language for the interface text in the installation wizard and software and confirm with [OK].
- ⇒ The installation wizard starts.
- ↵ Click [Next].
- ⇒ The installation wizard opens the software license agreement.
- ↵ If you want to accept the license agreement, select the appropriate option field and click [Next].
- ↵ If the suggested installation path is OK, click [Next].
If you want to specify a different path, click the [Browse] button. Select a different path, confirm with [OK] and click [Next].
- ↵ Click the [Install] button to start installation.
- ⇒ The wizard installs the software and places a shortcut on the desktop (.
- ↵ Click the [Finish] button to complete installation.

Installing the device manager (DTM) *Safety Device Collection*

Prerequisites:

- The *Sensor Studio* software is installed on the PC.
- ↵ Download the zip file of the configuration and diagnostic software *Setup_SafetyDeviceCollection...zip* from the Leuze website.
- ↵ Unzip the file.
- ↵ Double-click the file *Setup_SafetyDeviceCollection.exe*.
- ↵ Select a language for the interface text in the installation wizard and software and confirm with [OK].
- ⇒ The installation wizard starts.
- ↵ Click [Next].
- ⇒ The installation wizard opens the software license agreement.
- ↵ If you want to accept the license agreement, select the appropriate option field and click [Next].
- ↵ If the suggested installation path is OK, click [Next].
If you want to specify a different path, click the [Browse] button. Select a different path, confirm with [OK] and click [Next].
- ↵ Click the [Install] button to start installation.
- ⇒ The wizard installs the software.
- ↵ Click the [Finish] button to complete installation.

NOTICE	
	<p>During installation of the software, a user <i>admin</i> (without password query) is created so that you can start the software without user identification. If other users are registered (Tools > User management in the FDT frame menu), you must log in at the software with a user name and password.</p> <p>This setting allows you to connect to the safety sensor and to read out, upload, enter or change the safety configuration and all settings using the RSL 400 device DTM. The password for the safety sensor only needs to be entered (i.e. the access level only needs to be changed) when the changes are downloaded to the safety sensor (see chapter 4.5.1 "Selecting access level").</p>

4.3 User interface

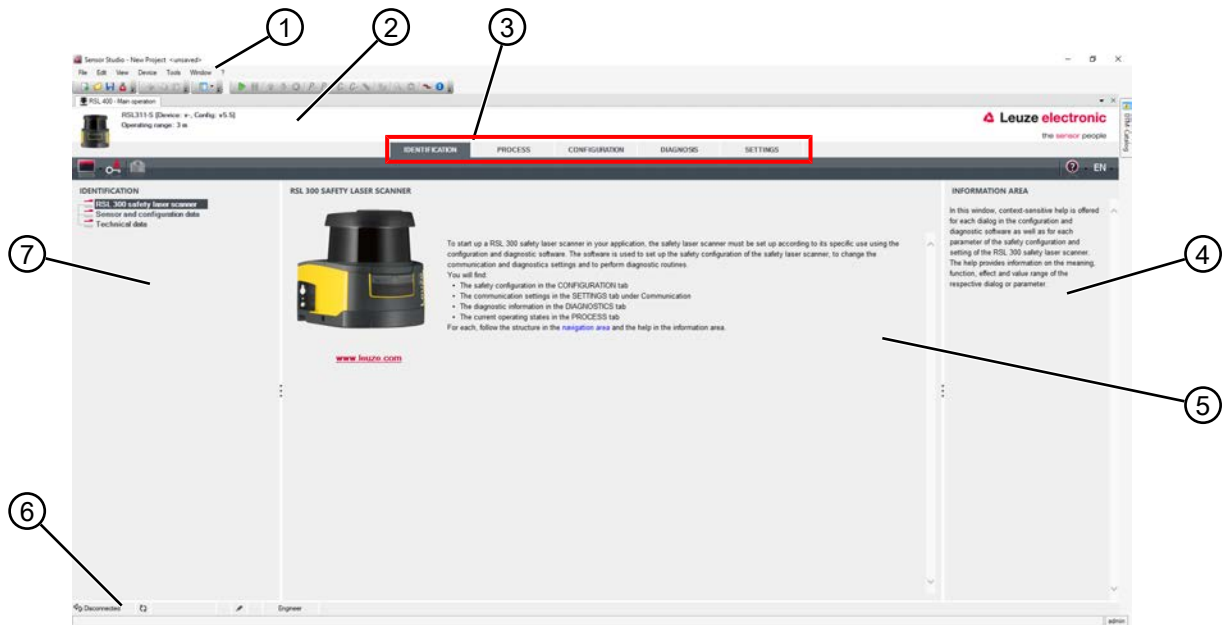

- 1 FDT frame menu with toolbar
- 2 RSL 300 device manager (DTM)
- 3 Navigation tabs
- 4 Information area
- 5 Dialog box
- 6 Status line
- 7 Navigation area

Fig. 4.1: User interface of the software

FDT frame menu

The device managers (DTM) of the safety sensors are created and managed in the FDT frame menu.

Device manager DTM

Configuration projects for setting up the selected safety sensor are created and managed in the device managers (DTM) of the safety sensors.

Project tree view

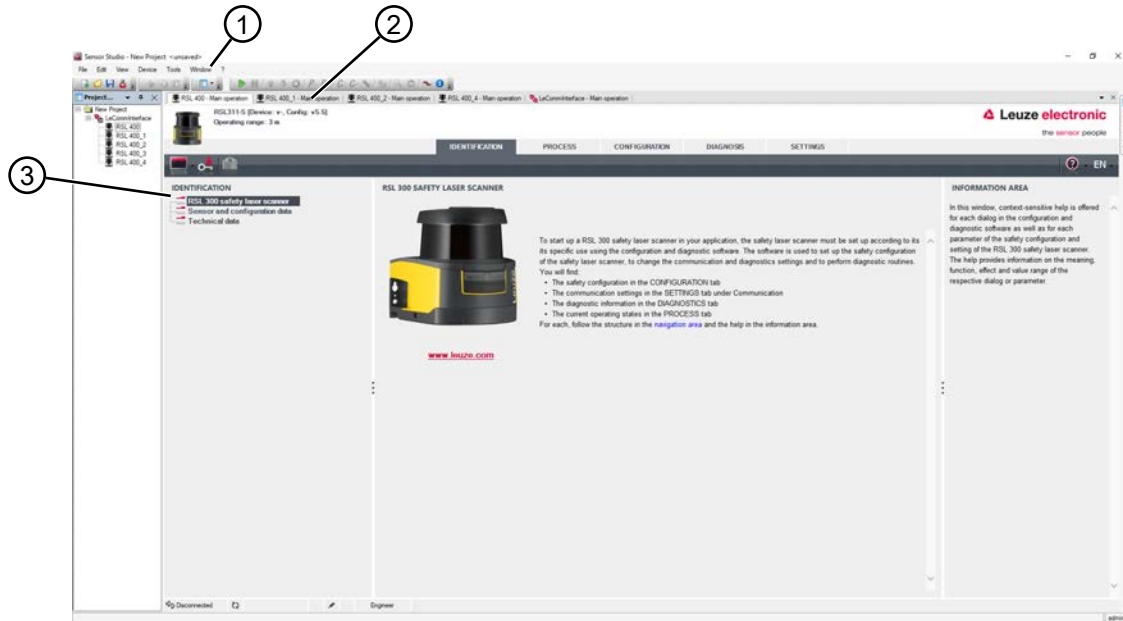

- 1 FDT frame menu
- 2 Device manager (DTM) tabs
- 3 Project tree view

Fig. 4.2: User interface with project tree view

The project tree view shows the structure of the currently installed device managers (DTM). In the project tree view you can, for example, add copies of an already configured device manager (DTM) quickly and easily to the DTM structure if you want to operate multiple safety sensors with the same configuration settings.

Example: AGV with safety sensors on front and rear side

4.4 FDT frame menu

NOTICE	
	<p>You can find complete information on the FDT frame menu in the online help system. Select the Help menu item in the menu [?].</p>

4.4.1 Project wizard

Using the Project Wizard you can create and change configuration projects for setting up the safety sensor (see chapter 4.5 "Using configuration projects").

Start the Project Wizard in the FDT frame menu by clicking the button.

NOTICE	
	<p>Information on the Project Wizard can be found in the online help for the FDT frame menu under Sensor Studio Options.</p>

4.4.2 DTM change

The *DTM Change* function makes it easier for you to call up the communication DTM of a device or change from device DTM to communication DTM.

↪ Start the *DTM change* function in the FDT frame menu by clicking the  button.

NOTICE	
	Information on <i>DTM change</i> can be found in the online help for the FDT frame menu under Sensor Studio Options .

4.4.3 User management

Using the user management in the FDT frame menu, you can create users, log users in/out and manage passwords.

Creating users

When creating a user in the user management via **Tools > User management** in the software frame menu, select the access level for the user. For information on access permissions and access levels (see chapter 5.1 "Authorization concept of safety sensor").

↪ In the FDT frame menu, click **Tools > User management > Create user**.

Logging users in/out

Prerequisites:

- Users have been created

↪ In the FDT frame menu, click **Tools > Log in/log out**.

Managing passwords

Prerequisites:

- Users have been created

↪ In the FDT frame menu, click **Tools > Change password**.

NOTICE	
	<p>Password management via the FDT frame menu applies to all installed device managers (DTM) of the project.</p> <p>Whenever write access occurs, the safety sensors of the RSL 300 series always check the access level (<i>Engineer, Expert</i>) and the password defined via the device manager (DTM) (SETTINGS > Passwords) independently of the password management via the FDT frame menu.</p>

4.4.4 Exiting Sensor Studio

When you have finished making the configuration settings, close the configuration and diagnostic software.

↪ Exit the program via **File > Exit**.



↪ Save the configuration settings as a configuration project on the PC.

You can open the configuration project again at later time via **File > Open** or with the *Sensor Studio* Project Wizard (.

4.5 Using configuration projects

Configuration projects are created and managed in the device manager (DTM) of the selected safety sensor.

NOTICE	
	<p>During installation of the software, a user <i>admin</i> (without password query) is created so that you can start the software without user identification. If other users are registered (Tools > User management in the FDT frame menu), you must log in at the software with a user name and password.</p> <p>This setting allows you to connect to the sensor and to read out, upload, enter or change the safety configuration and all settings using the RSL 400 device DTM. The password for the sensor only needs to be entered (i.e. the access level only needs to be changed) when the changes are downloaded to the safety sensor (see chapter 4.5.1 "Selecting access level").</p>

- ↪ Start the configuration and diagnostic software on the PC by double-clicking the  button.
 - ⇒ The **mode selection** of the Project Wizard is displayed.
 - ⇒ If the **mode selection** is not shown, start the Project Wizard in the FDT frame menu by clicking the [Project Wizard] button ().

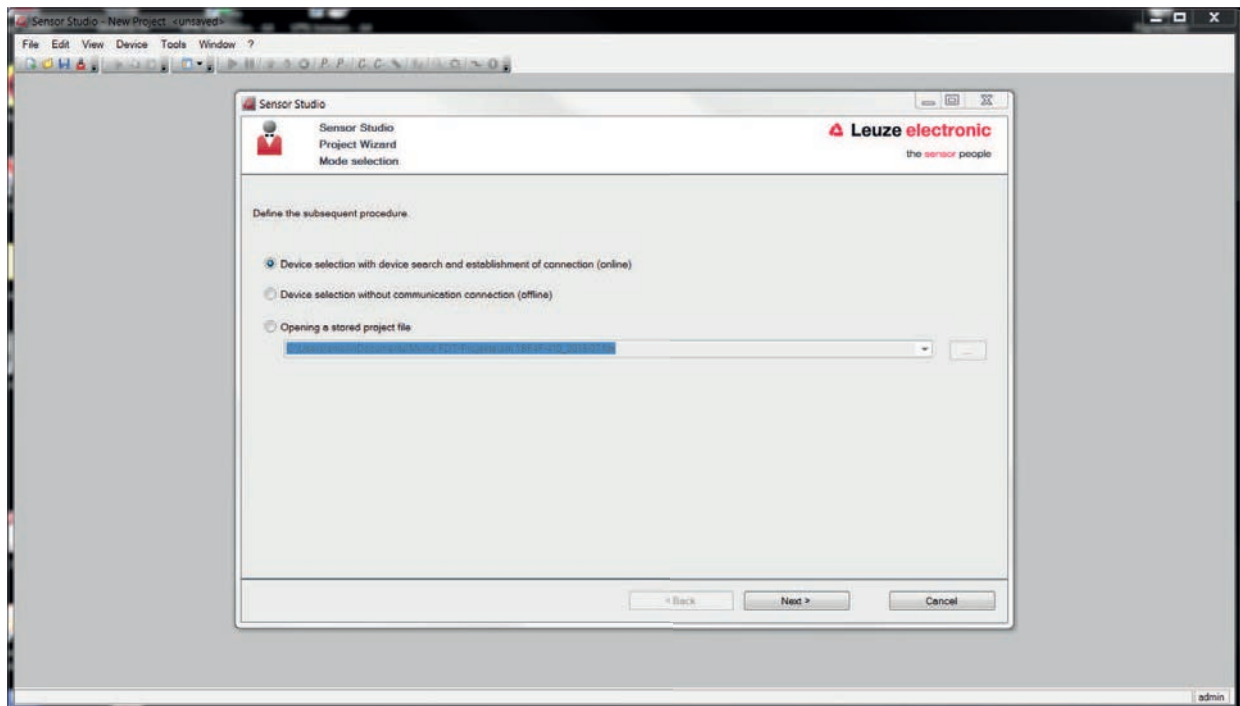
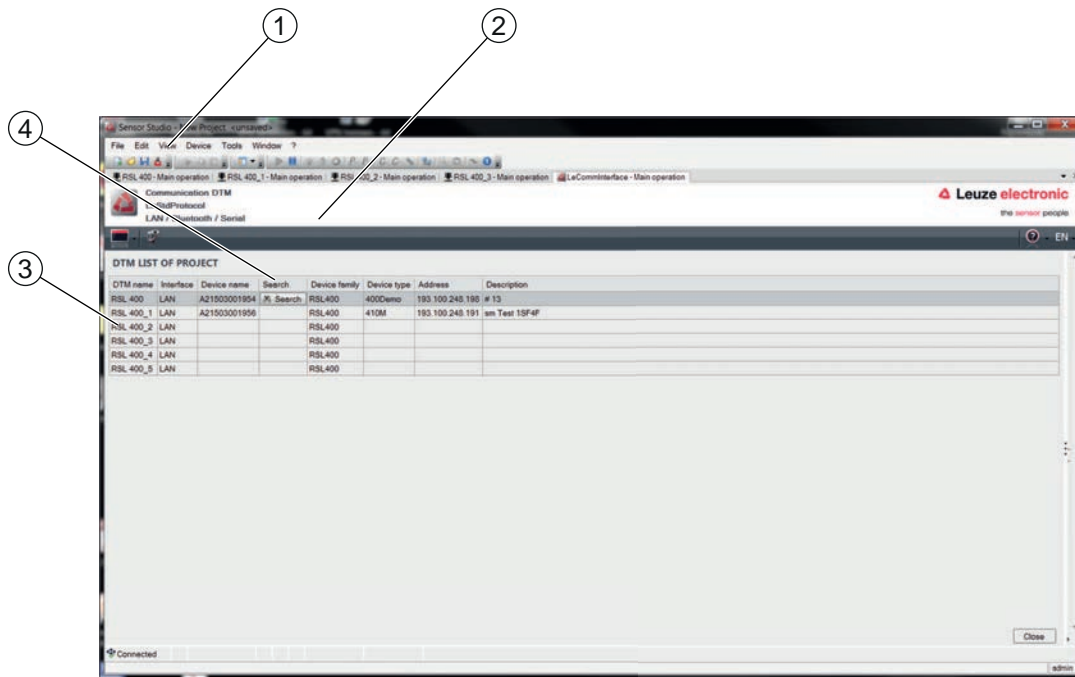

Fig. 4.3: Project wizard

- ↪ Select the configuration mode and click [Next].
 - ⇒ Automatic connection to a connected safety sensor (**Online**)
 - ⇒ Device selection without communication connection (**offline**)
 - ⇒ Load a saved project again
- ⇒ The project wizard displays the **SEARCH DEVICES** dialog box.
- ↪ Select the interface and click the [Start] button.
- ↪ Find the safety sensor for your configuration project using the search function of the communication DTM.



- 1 FDT frame menu
- 2 Communication DTM
- 3 Device list
- 4 Search function

Fig. 4.4: Communication DTM with search function

⇒ The project wizard displays the device list of configurable safety sensors in the **SEARCH DEVICES** dialog box.

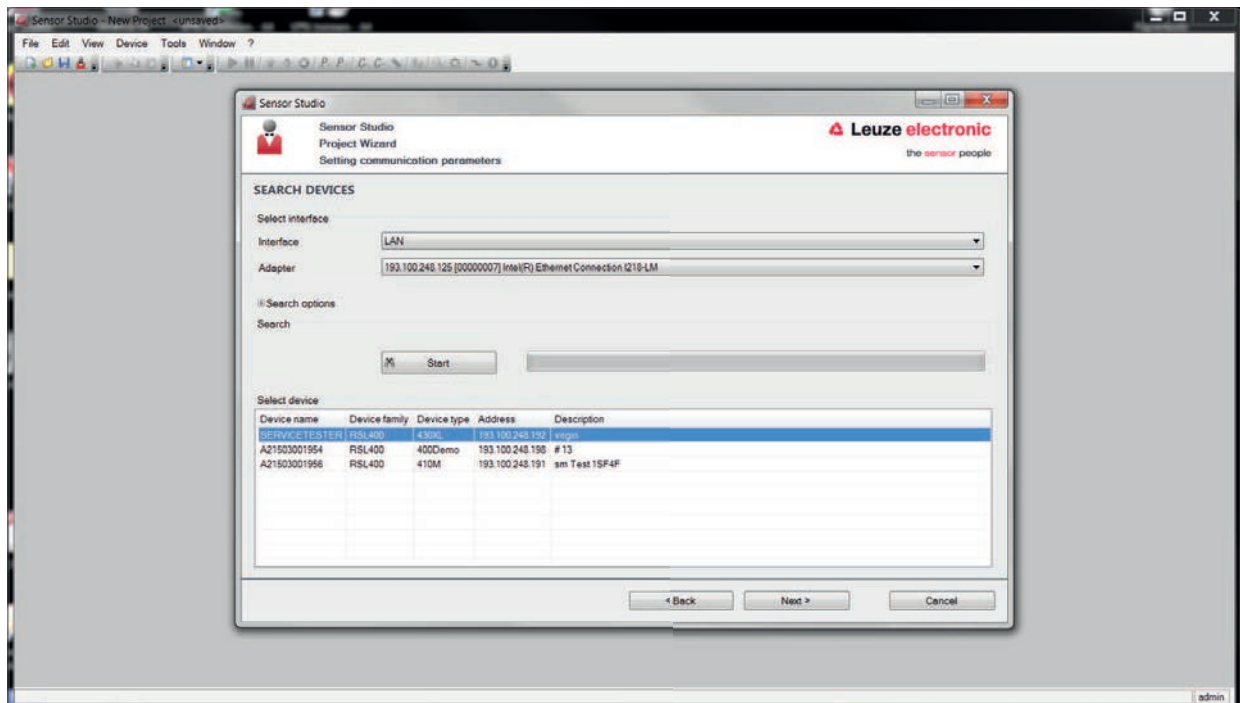

Fig. 4.5: Device selection in project wizard

⇒ Select the safety sensor from the device selection list and click [Next].

⇒ The device manager (DTM) of the safety sensor shows the initial screen for the configuration project.

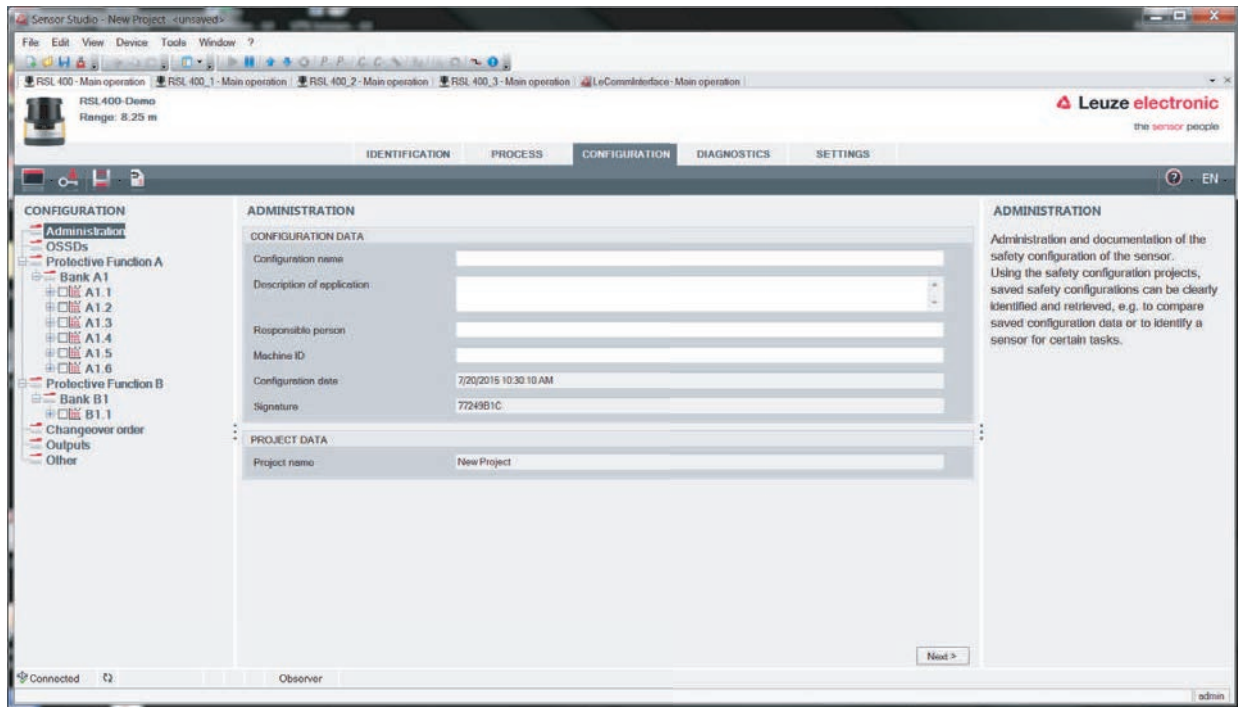



Fig. 4.6: Initial screen for safety configuration

NOTICE	
	<p>The device manager (DTM) starts without querying the access level of the user. During communication with the safety sensor, the safety sensor does however query the access level of the user. To change the access levels (see chapter 4.5.1 "Selecting access level").</p>

Setting device manager

Using the menus of the device manager (DTM) you can set the parameters of the safety configuration. The online help system provides information on the menu items and adjustment parameters. Select the **Help** menu item in the menu [?].

4.5.1 Selecting access level

Using the device manager you can change the access level of the user if necessary. For the authorization concept of the software, see chapter 5.1 "Authorization concept of safety sensor".

- ↳ Click in the DTM menu bar on the [Change access level] button ().
- ⇒ The **Change access level** dialog box opens.

- ↳ In the *Access level* list, select the item *Expert*, *Engineer* or *Observer* and enter the default password or the password defined for the individual user.

The following access levels are available:

- *Observer* can read everything (no password)
- *Expert* can change communication and diagnostics settings (default password = **comdiag**)
- *Engineer* can additionally change the safety configuration (default password = **safety**)

The password is case-sensitive (i.e. a distinction is made between upper-case and lower-case letters).

- ↳ Confirm with [OK].

4.5.2 IDENTIFICATION

Detailed information on the menu items and setting parameters can be found in the information area and in the online help. Select the **Help** menu item in the menu [?].

- RSL 300 safety laser scanner
- Sensor and configuration data
- Technical data

4.5.3 PROCESS

Detailed information on the menu items and setting parameters can be found in the information area and in the online help. Select the **Help** menu item in the menu [?].

- Sensor display
 - Device display in the DTM menu
 - SENSOR DISPLAY
 - STATE OF THE ACTIVE PROTECTIVE AND WARNING FIELDS
 - SENSOR DATA
- Measurement contour
- Inputs / outputs
 - SENSOR DISPLAY
 - CONNECTIONS AND SIGNALS
- Simulation – only with access level *Engineer*
 - Measurement contour
 - Inputs / outputs

4.5.4 CONFIGURATION

see chapter 9 "Configuring the safety sensor"

NOTICE	
	<p>You can only transfer changes made in the CONFIGURATION menu to the safety sensor if you are logged in with the access level <i>Engineer</i>.</p>

4.5.5 DIAGNOSIS

Alignment

Display of safety sensor alignment using the integrated electronic spirit level

Prerequisites: The software and safety sensor are connected.

- ↳ In the **DIAGNOSIS** menu, click the [Align sensor mechanically] button ().
- ⇒ The safety sensor display shows the horizontal and vertical alignment in degrees.

Visually identify device

If you have installed multiple safety sensors, identify the safety sensor that is connected to the currently open device manager (DTM).

Prerequisites: The software and safety sensor are connected.

- ↳ In the **DIAGNOSIS** menu, click the [Visually identify sensor] button ().
- ⇒ In the display of the safety sensor connected to the device manager (DTM), the message "PING received" flashes for ten seconds.

Reset sensor

Acknowledge messages and faults

Set safety sensor to safety mode

Create and save service file

The service file contains all available information on the safety sensor as well as configuration and settings.

When requesting support, send the service file to the Leuze customer service (see chapter 14 "Service and support").

Sensor display

Device display in the DTM menu

- SENSOR DISPLAY
- STATE OF THE ACTIVE PROTECTIVE AND WARNING FIELDS
- SENSOR DATA

Diagnostics list**Access list****EventLog****4.5.6 SETTINGS**

NOTICE	
	You can only transfer changes made in the SETTINGS menu to the safety sensor if you are logged in with the access level <i>Engineer</i> .

Communication

- LAN
 - DHCP
 - CONNECTION SETTINGS
 - MAC address

EventLog

Trigger signals output when certain events occur, are recorded and shown in the event list of the safety sensor.

Information on the monitored signals can be found in the *Sensor Studio* configuration and diagnostic software in the information area and in the online help. Select the **Help** menu item in the menu [?].

Sensor display

Activation of the safety sensor alphanumeric display.

Information on the display options can be found in the *Sensor Studio* configuration and diagnostic software in the information area and in the online help. Select the **Help** menu item in the menu [?].

Passwords

NOTICE	
	If a user has forgotten his password for login at the safety sensor or has repeatedly entered the password incorrectly, he cannot log in at the safety sensor. The CHANGE PASSWORD function is therefore not available. To reset the password, a user must generate a reset password and have it confirmed by the manufacturer.

CHANGE PASSWORD

- ↳ Define individual passwords for the access levels *Engineer* and *Expert*. These passwords replace the default passwords set by the manufacturer.
The password is case-sensitive (i.e. a distinction is made between upper-case and lower-case letters).

Reset password

Prerequisites:

- The software is connected to the safety sensor.
- ↳ Generate a one-time password.
Note down the generated reset password.
- ↳ Send the reset password to the Leuze customer service for confirmation (see chapter 14 "Service and support").
The device can now be switched off and the connection can be terminated.
- ↳ Enter the confirmed reset password and create a new password.

Optics cover

- Monitoring of optics cover
- Dialog box for calibrating a replacement optics cover

Field editor display options

Display settings for the field editor when defining protective/warning fields.

- CONTOUR ALIGNMENT
- COORDINATE DISPLAY
- EDITOR BEHAVIOR

Information on the display options can be found in the *Sensor Studio* configuration and diagnostic software in the information area and in the online help. Select the **Help** menu item in the menu [?].

5 Functions

The functions of the safety sensor must be matched to the respective application and its safety requirements. You can activate/deactivate the functions and adapt them using parameters. You configure the functions with the help of the configuration and diagnostic software (see chapter 9 "Configuring the safety sensor").

- You configure the functions of the safety sensor in the software as configuration projects.
- In each configuration project you determine the protective function and the configurable field pairs via the selected function mode.
- The switchable protective/warning field pairs for the selected function mode are defined in configuration banks.
- You determine the resolution, the start-up behavior, the response time and, where applicable, the vehicle speed together for all protective/warning field pairs of a configuration bank.

5.1 Authorization concept of safety sensor

User management allows target-group-oriented communication between the software and the safety sensor. Which functions are available depends on the selected **access level** of the user. For information on the software and on user management (see chapter 4 "Configuration and diagnostic software Sensor Studio").

- Changing the safety configuration as well as the communication and diagnostics settings of the sensor is only permitted for certain access levels.
- Installation and operation of the software do not depend on the access level of the user.

The following access levels are available:

Tab. 5.1: Access levels and functions available

Access level	Functions
Observer	<ul style="list-style-type: none"> • Display the measurement contour • Upload and display configuration data from the safety sensor • Display status information from the safety sensor • Display diagnostics list • Customize display • Display and evaluate the measurement contour • Load configuration data from the safety sensor • Load status information from the safety sensor • Display diagnostics list • Create service file • Reset password
Expert	<p>In addition to the functions of the <i>Observer</i></p> <ul style="list-style-type: none"> • Load the signed safety configuration from a file and transfer/download to the safety sensor • Transfer changed communication and diagnostics settings from the PC to the safety sensor • Print configuration data incl. protective/warning fields • Calibrate optics cover

Access level	Functions
Engineer	<p>In addition to the functions of the <i>Expert</i>, full access to all user-relevant functions and parameters:</p> <p>Create and change a safety configuration:</p> <ul style="list-style-type: none"> • Save configuration data to file • Change all parameters of configuration • Reset safety sensor to default values • Define and change protective/warning fields • Set reference contour in protective field • Print and delete protective/warning fields • Load protective/warning field data from file • Save protective/warning field data • Transfer protective/warning field data from the PC to the safety sensor • Change passwords

NOTICE



The software saves individual passwords in the connected safety sensor, thereby ensuring that only authorized users can change the existing configuration.

Determining access level

When creating a user in the user management via **Tools > User management** in the FDT frame menu, select the access level for the user. In the user management you can also create and change passwords for the users.

Using the device manager (DTM) you can change the access level of the user (see chapter 4.5.1 "Selecting access level").

Click in the DTM menu bar on the [Change access level] button .

5.2 Function modes of safety sensor

You configure the functions of the safety sensor in configuration projects with the help of the configuration and diagnostic software. In each configuration project you determine the protective function and the configurable field pairs via the selected function mode.

You select the function mode of the safety sensor in the software device manager (DTM) with **CONFIGURATION > OSSDs** (see chapter 9 "Configuring the safety sensor").

You use the protective function to define the criteria for switching off the safety-related switching outputs (see chapter 3.1.2 "Parameters for protective function").

The switchable protective and warning field pairs for the selected function mode are defined in the configuration banks, e.g. **CONFIGURATION > Protective function A > Bank A1**.

Overview of the function modes

Tab. 5.2: Function modes

Function mode	Field pairs (FP) Protective fields (PF) Warning fields (WF)	Field pair activation
One protective function	1 FP / 1 PF + 1 WF	Fixed selection of one field pair
One protective function – four field mode	1 FP / 1 PF + 3 WF	Fixed selection of one field pair

5.2.1 One protective function

A fixed field pair for safety-related switching outputs OSSD-A.

5.2.2 One protective function – four field mode

The safety sensor monitors one protective field and three warning fields.

Monitoring is performed together for the field pairs of protective function A and protective function B. If, for example, the control system is monitoring field pair A1.1 for protective function A, field pair B1.1 for protective function B is also monitored.

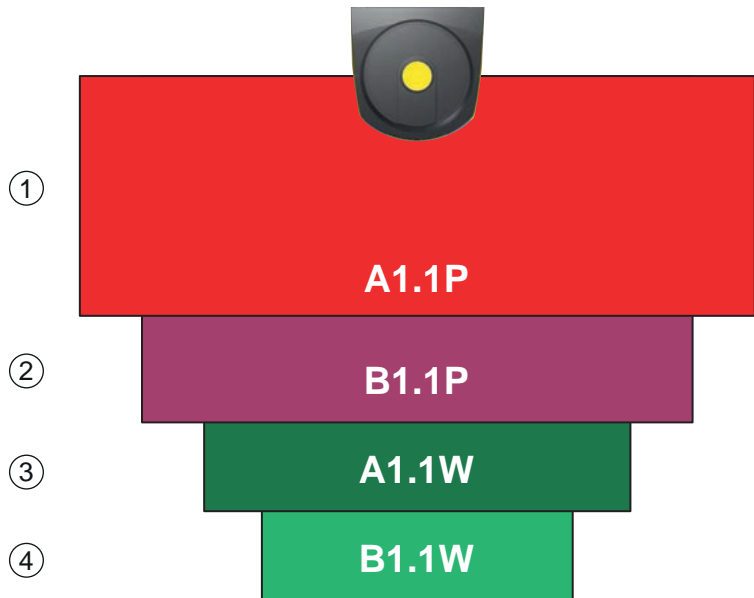

- 1 Protective function A: protective field
- 2 Protective function B: protective field
- 3 Protective function A: warning field
- 4 Protective function B: warning field

Fig. 5.1: Four field mode

If the protective field of protective function A is violated, safety-related switching outputs OSSD-A switch. If the protective field of protective function B is violated, the indication signal B-CLEAR is generated – the safety-related switching outputs do not switch.

The signals are assigned to the switching outputs via the configuration and diagnostic software (**CONFIGURATION > Outputs**; see chapter 9 "Configuring the safety sensor").

Tab. 5.3: Example: Assignment of signals to switching outputs

Logic signal	Electrical switching output	Description
OSSD A	Safety-related switching outputs OSSD A	Protective function A: protective field violation
B-CLEAR	Switching output MELD – not safe	Protective function B: protective field violation
A-WF-VIO	Switching output A1	Protective function A: Violation of warning field
B-WF-VIO	Switching output EA1	Protective function B: Violation of warning field

5.3 Selectable resolution for hand, leg and body detection

The application-specific resolution of the safety sensor is defined in the configuration project together for all protective/warning field pairs of a configuration bank.

Tab. 5.4: Resolution of the safety sensor depending on the function

Safety sensor resolution [mm]	Function	Application(s)
50	Leg detection with the safety sensor mounted close to floor level	Danger zone safeguarding
70	Leg detection with the safety sensor mounted at a height of 300 mm	Stationary danger zone safeguarding Mobile danger zone safeguarding
Mounting height = Height of the scan level above floor level		

5.4 Speed-dependent protective function for vehicles

For object detection in the case of mobile applications, the safety sensor evaluates the relative speed of the object. If the safety sensor is mounted on vehicles or on moving parts of machines, the maximum speed of the vehicle must be entered during configuration of the protective function.

The maximum vehicle speed (*Max. AGV speed*) is selected in the configuration project together for all protective/warning field pairs of a configuration bank.

5.5 Response time

The response time is the maximum time from a protective field violation to switch-off of the safety-related switching outputs.

The response time is selected in the configuration project together for all protective/warning field pairs of a configuration bank.

5.6 Configurable start-up behavior

The start-up behavior is selected in the configuration project together for all protective/warning field pairs of a configuration bank.

5.6.1 Automatic start/restart

The machine starts automatically as soon as the machine is switched on or the supply voltage returns and when the protective field is free again.

Using automatic start/restart

You can use the *automatic start/restart* function under the following prerequisites:

- The *start/restart interlock* function is taken over by a downstream safety-related component of the machine control system.
 - or:
 - It is not possible to walk behind or go around the effective protective field.
- ↳ Allow for an optical and/or acoustic start warning.

Automatic start-up

The *automatic start-up* function starts the machine automatically as soon as the supply voltage is present.

Automatic restart

The *automatic restart* function starts the machine automatically as soon as the protective field is free again.

5.6.2 Start interlock/automatic restart

With start interlock/automatic restart, the safety sensor remains in the OFF state when, following a power supply interruption, the voltage supply is restored. After violation of the protective field, the system restarts when the protective field is free again.

The *start/restart interlock* has two functions:

- Start interlock
- Automatic restart

Using start interlock/automatic restart

- ↪ In addition to the safety sensor you must also install the reset button. The machine operator starts the machine with this reset button.
- ↪ Position the reset button outside the danger zone so that it cannot be activated from the protective fields and danger zones. The operator must be able to see all danger zones from this position.
- ↪ Identify the area to be released on the reset button so that its meaning is clear and easy to understand.
- ↪ Ensure that nobody is in the danger zone **before** pressing the reset button.
- ↪ Hold down the reset button for between 0.12 s and 4 s to enable the safety-related switching outputs.

 DANGER
<p>Risk of death if start-up is operated unintentionally!</p> <ul style="list-style-type: none"> ↪ Ensure that the reset button for unlocking the start interlock cannot be reached from the danger zone. ↪ Before unlocking the start interlock, make certain that no people are in the danger zone.

Start interlock

The *start interlock* function prevents the machine from starting automatically after switching on or after the supply voltage returns.

The machine only starts when you press the reset button.

Automatic restart

The *automatic restart* function starts the machine automatically as soon as the protective field is free again.

5.6.3 Start/restart interlock (RES)

When accessing the protective field, the start/restart interlock ensures that the safety sensor remains in the OFF state after the protective field has been cleared. It prevents automatic release of the safety circuits and automatic start-up of the system, e.g. if the protective field is again clear or if an interruption in the voltage supply is restored.

The *start/restart interlock* has two functions:

- Start interlock
- Restart interlock

NOTICE	
	<p>For access guarding, the start/restart interlock function is mandatory. The protective device may only be operated without start/restart interlock in certain exceptional cases and under certain conditions acc. to EN ISO 12100.</p>

Using start/restart interlock

- ↪ In addition to the safety sensor you must also install the reset button. The machine operator starts the machine with this reset button.
- ↪ Position the reset button outside the danger zone so that it cannot be activated from the protective fields and danger zones. The operator must be able to see all danger zones from this position.
- ↪ Identify the area to be released on the reset button so that its meaning is clear and easy to understand.
- ↪ Ensure that nobody is in the danger zone **before** pressing the reset button.
- ↪ Hold down the reset button for between 0.12 s and 4 s to enable the safety-related switching outputs.

 DANGER	
	<p>Risk of death if start/restart is operated unintentionally!</p> <ul style="list-style-type: none"> ↳ Ensure that the reset button for unlocking the start/restart interlock cannot be reached from the danger zone. ↳ Before unlocking the start/restart interlock, make certain that no people are in the danger zone.

Start interlock

The *start interlock* function prevents the machine from starting automatically after switching on or after the supply voltage returns.

The machine only starts when you press the reset button.

Restart interlock

The *restart interlock* function prevents the machine from starting automatically, as soon as the protective field is free again. The *restart interlock* function always includes the *start interlock* function.

The machine only starts again when you press the reset button.

5.7 Reference contour monitoring

The *reference contour monitoring* function prevents unintentional misalignment and deliberate manipulation of the safety sensor. If a protective field contains an area with reference contour, the safety sensor not only monitors interruptions of the protective field, it also monitors the concurrence of the measured area contour with the set reference contour. The distance between the protective field and the reference must not exceed 100 mm. If the measurement values of the area contour deviate from the defined reference contour, i.e., if no object is detected in the area with reference contour (200 mm from the protective field), the safety sensor switches off and the safety-related switching outputs (OSSDs) switch to *off*.

Activation of the function

- ↳ Activate the *Reference contour monitoring* function together with the definition of the protective field boundaries using the configuration and diagnostic software (see chapter 9.4.4 "Creating and configuring protective/warning field pairs").

5.8 EDM contactor monitoring

The *EDM contactor monitoring* function dynamically monitors the contactors, relays or valves connected downstream of the safety sensor. Prerequisite for this are switching elements with positive-guided feedback contacts (normally closed contacts).

Activation of the function

- ↳ Activate the contactor monitoring function using the configuration and diagnostic software (see chapter 9.4 "Configuring protective function").

If contactor monitoring is activated, it operates dynamically, i.e., in addition to monitoring the closed feedback circuit every time before the OSSDs are switched on, it also checks whether the feedback circuit has opened within 500 ms after release and whether it has closed again within 500 ms after the OSSDs switched off. If this is not the case, the OSSDs return to the OFF state after being switched on briefly. A message is displayed on the alphanumeric display and the safety sensor switches to the fault interlock state:



- With the OSSDs switched off, +24 V must be present at the EDM input.
- With the OSSDs switched on, the EDM circuit must be open (high impedance).

5.9 Expanded shock monitoring

The *expanded shock monitoring* function is used to change the start-up behavior of the safety sensor following an error caused by a shock or vibrations.

If expanded shock monitoring is deactivated, errors caused by external mechanical influences can be acknowledged by an input signal depending on the configured start-up behavior (see chapter 5.6 "Configurable start-up behavior").

If the *expanded shock monitoring* function is activated, errors caused by shock or vibrations can then only be acknowledged by a competent person and a minimum access level of "Engineer" via the Sensor Studio configuration and diagnostic software and an active connection to the safety sensor (see chapter 9.5 "Configuring expanded shock monitoring").

 ATTENTION	
	<ul style="list-style-type: none">↪ Always make sure that the device is only used within its specifications and under the conditions described in these operating instructions.↪ Protect the device from mechanical damage (see chapter 7 "Mounting").↪ Regularly check the safety sensor for any obvious signs of damage or change and perform a regular test of the detection capability (see chapter 11 "Testing").

6 Applications

The following chapters essentially describe the safety sensor's usage possibilities.

- To safely mount the safety sensor for the respective application, see chapter 7 "Mounting".
- For the electrical connection of the safety sensor, see chapter 8 "Electrical connection".
- To safely configure the safety sensor for the respective application, see chapter 9 "Configuring the safety sensor".

6.1 Stationary danger zone guarding

Stationary danger zone guarding enables a very spacious protection of people on machines that are to remain as accessible as much as possible. The safety sensor is applied as a stop-activating and presence-detecting protective device. The safety sensor's protective field is set up horizontally in front of the machine or system's point of operation.

You can also use the stationary danger zone guarding if you do have to guard areas under the machine or at the rear that are not visible.

If the danger zone changes during operation, the respective danger zone is guarded by means of a field pair changeover while the working area is accessible.



- 1 Safety sensor
- 2 Danger zone, protective function activated

Fig. 6.1: Stationary danger zone guarding

6.2 Stationary point of operation guarding

Hand and arm protection are always required when people must work at the point of operation. The safety sensor is applied as a stop-activating and presence-detecting protective device. The safety sensor's protective field is set up vertically in front of the machine or system's point of operation. In accordance with EN ISO 13855, resolutions from 14 to 40 mm make sense here. This yields the necessary safety distance for finger protection, among others (see chapter 7.3 "Stationary point of operation guarding").

6.3 Stationary access guarding

Stationary access guarding protects people that step into a danger zone. The vertically aligned protective field of the safety sensor detects the passage of a person. A side post and the floor serve as reference contour for monitoring the position of the protective field. In contrast to danger zone guarding, the safety sensor no longer registers a person in the danger zone after the passage. This is why the *start/restart interlock* function is vital for access guarding.



- 1 Safety sensor
- 2 Reference contour
- 3 Danger zone 1, protective function activated
- 4 Danger zone 2, protective function deactivated

Fig. 6.2: Stationary access guarding

6.4 Mobile danger zone guarding

Mobile danger zone guarding protects people that are located in the transportation path of an automated guided vehicle (AGV). The distance between the protective field front edge and the vehicle front must be greater than the stopping distance of the vehicle with selected speed and maximum load. A safety control selects speed-dependent protective fields and can activate side horizontal protective fields for curved stretches.

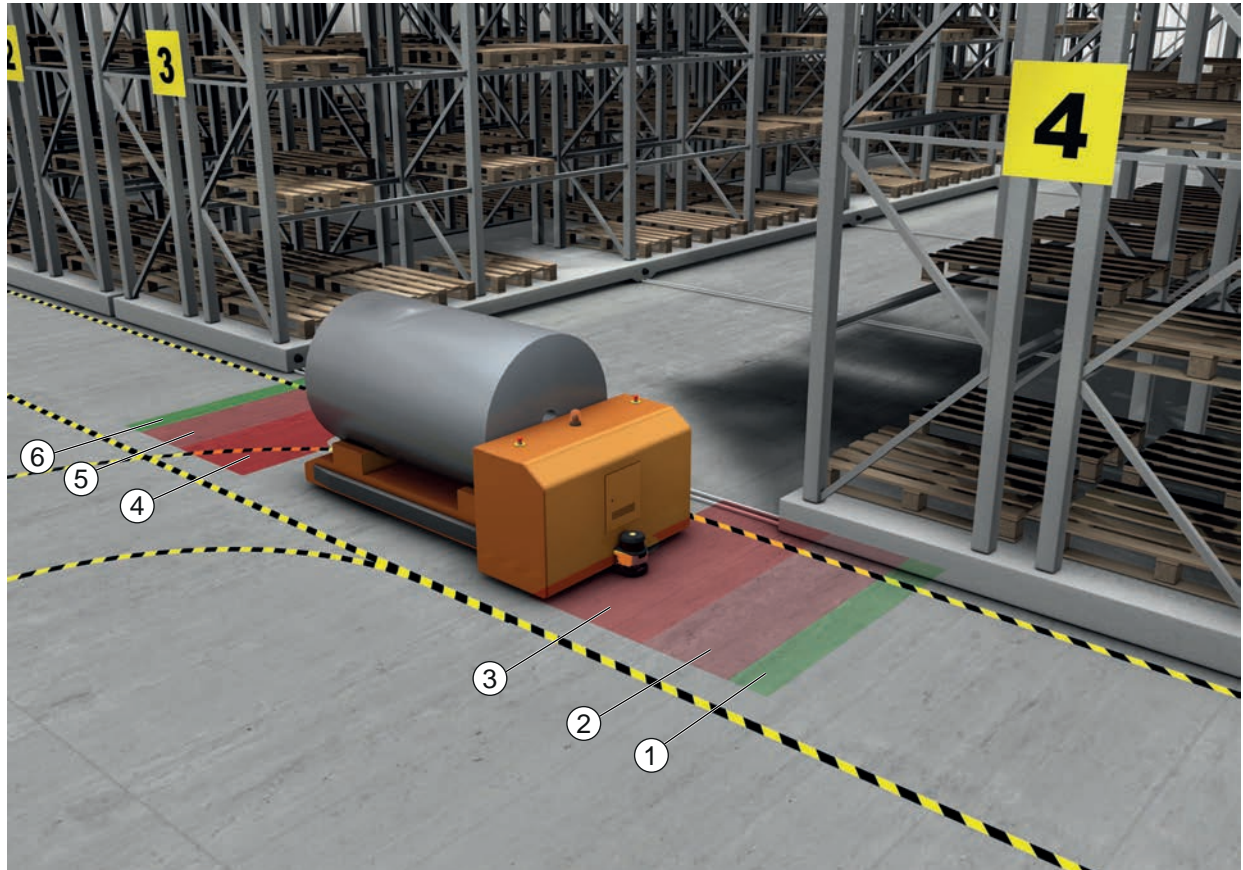

- 1 Warning field for forward travel
- 2 Protective field 1 for forward travel, deactivated
- 3 Protective field 2 for forward travel, activated
- 4 Protective field 1 for reverse travel, activated
- 5 Protective field 2 for reverse travel, deactivated
- 6 Warning field for reverse travel

Fig. 6.3: Mobile danger zone guarding

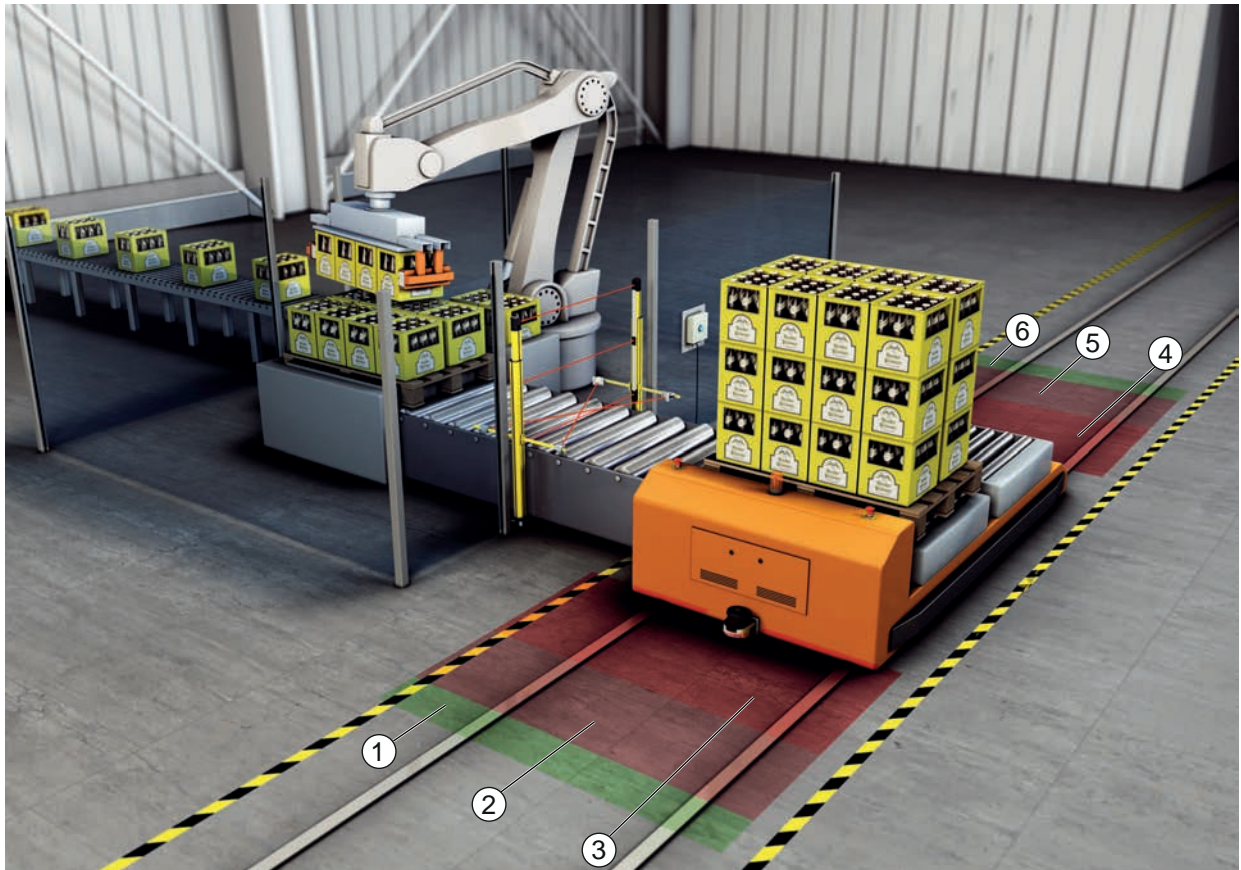

- 1 Warning field for forward travel
- 2 Protective field 1 for forward travel, deactivated
- 3 Protective field 2 for forward travel, activated
- 4 Protective field 1 for reverse travel, activated
- 5 Protective field 2 for reverse travel, deactivated
- 6 Warning field for reverse travel

Fig. 6.4: Mobile danger zone guarding

6.5 Danger zone safeguarding on side-tracking skates

Side-tracking skate guarding

Side-tracking skate guarding protects personnel who are located in the transportation path of a transverse side-tracking skate (TSS). One safety sensor is mounted in each direction of travel. The safety sensor that is mounted opposite the current direction of travel is deactivated. Evaluation of the warning field allows the transverse side-tracking skate to be braked gently. To ensure optimum material transport, the control changes over the protective/warning field pair depending on the state and speed.

Mobile side guarding

Mobile side guarding protects people and objects that are located on the vehicles path. This application is used when very low arranged roller conveyors do not permit an unobstructed passage of horizontal, lateral protrude protective fields. The safety sensors are positioned laterally and the protective fields are arranged vertically, at a slight tilt. The position of the front edges of the side protective fields is oriented here on the position of the front edge of the horizontal protective field.



- 1 Protective and warning field pair for forward travel, activated
- 2 Protective and warning field pair for side guarding, left, activated
- 3 Protective and warning field pair for side guarding, right, activated
- 4 Protective and warning field pair for reverse travel, deactivated



Fig. 6.5: Mobile side guarding on side-tracking skates

7 Mounting

The safety sensor's protective function is only guaranteed when the device arrangement, configuration, protective field dimensioning and mounting are coordinated with the respective application.

The installation work must only be performed by a competent person in compliance with the applicable standards and these instructions. The mounting must be thoroughly inspected on completion.

- ↳ You must observe and comply with the respective relevant machine-specific standards and regulations (see chapter 16 "Standards and legal regulations").
- ↳ Observe the basic information on mounting (see chapter 7.1 "Basic infos").

	WARNING
	<p>Improper mounting may result in serious injury!</p> <p>The protective function of the safety sensor is only ensured if appropriately and properly mounted for the respective, intended area of application.</p> <ul style="list-style-type: none"> ↳ Only allow competent persons to install the safety sensor. ↳ Maintain the necessary safety distances (see chapter 7.1.1 "Calculation of safety distance S"). ↳ Make sure that stepping behind, crawling under or stepping over the protective device is reliably ruled out and reaching under, over or around is taken into account in the safety distance, if applicable with additional distance C_{RO} corresponding to EN ISO 13855. ↳ Mount the safety sensor in such a way that it is protected from being damaged. ↳ If the vibration and shock requirements are above the values specified in this document, vibration damping measures must be implemented. ↳ Take measures to prevent that the safety sensor can be used to gain access to the danger zone, e.g. by stepping or climbing into it. ↳ Observe the relevant standards, regulations and these instructions. ↳ After mounting, check the safety sensor for proper function. ↳ Clean the safety sensor at regular intervals. Environmental conditions: see chapter 15 "Technical data" Care: see chapter 13 "Care, maintenance and disposal"

7.1 Basic infos

7.1.1 Calculation of safety distance S

Optical protective devices can only perform their protective function if they are mounted with adequate safety distance. When mounting, all delay times must be taken into account, such as the response times of the safety sensor and control elements as well as the stopping time of the machine, among others.

The following standards specify calculation formulas:

- EN ISO 13855, "Safety of machines - The positioning of protective device in respect of approach speeds of parts of the human body": mounting situation and safety distances.

General formula for calculating the safety distance S of an Optoelectronic Protective Device acc. to EN ISO 13855

$$S = K \cdot T + C$$

S	[mm]	Safety distance
K	[mm/s]	Approach speed
T	[s]	Total time of the delay, sum from ($t_a + t_i + t_m$)
t_a	[s]	Response time of the protective device
t_i	[s]	Response time of the safety relay
t_m	[s]	Stopping time of the machine
C	[mm]	Additional distance to the safety distance

NOTICE	
	If longer stopping times are determined during regular inspections, an appropriate additional time must be added to t_m .

7.1.2 Suitable mounting locations

Area of application: Mounting

Tester: Technician who mounts the safety sensor

Tab. 7.1: Checklist for mounting preparations

Check:	Yes	No
Is the safety distance to the hazard location maintained?		
Has the scanning angle of the safety sensor as given on the marking/template on the top of the sensor been taken into consideration?		
Can the point of operation or the danger zone only be accessed through the protective field?		
Have measures been taken to prevent the protective field from being bypassed by crawling under?		
Is stepping behind the protective device prevented or is mechanical protection available?		
Can the safety sensors be fastened in such a way that they cannot be moved and turned?		
Is the safety sensor accessible for testing and replacing?		
Is it impossible to actuate the reset button from within the danger zone?		
Can the entire danger zone be seen from the installation site of the reset button?		
Are the safety sensor and the connectors securely mounted and free of obvious signs of damage, changes or tampering?		

NOTICE	
	If you answer one of the items on the checklist with <i>no</i> , the mounting location must be changed.

7.1.3 Mounting the safety sensor

Proceed as follows:

- ↪ Calculate the necessary safety distance and determine the required additional distances for your application.
- ↪ Determine the mounting location.
 - Observe the information regarding the mounting locations; see chapter 7.1.2 "Suitable mounting locations"
 - Ensure that machine parts, safety guards or covers do not impair the safety sensor's field of vision.
 - Make sure that the scanning range of the safety sensor is not limited. To mount the safety sensor taking the scanning range into consideration, a template must be attached to the top cover of the safety sensor.

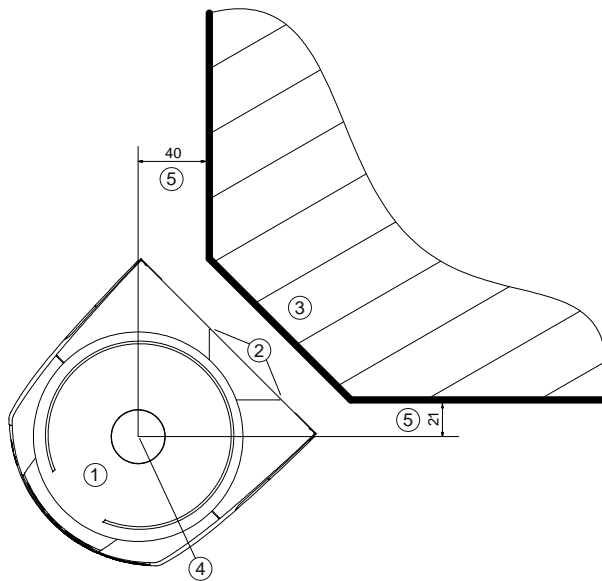

- all dimensions in mm
- 1 Safety sensor
 - 2 Template (markings on safety sensor)
 - 3 Mounting location
 - 4 Reference point for distance measurement and protective field radius
 - 5 Area with unobstructed view; must remain free

Fig. 7.1: Mounting taking the scanning range of 270° into consideration

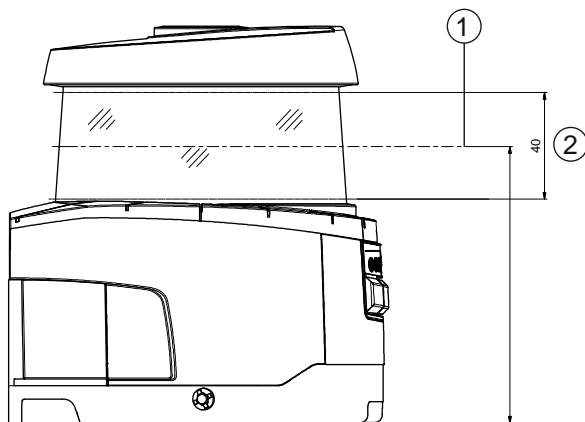

- all dimensions in mm
- 1 Scan level
 - 2 Area with unobstructed view; must remain free (40 mm)

Fig. 7.2: Mounting: area with unobstructed view

- ↪ Determine whether you are going to install the safety sensor with or without the mounting system. During mounting, use the four supplied M5 screws or four similar screws with a diameter of 5 mm, and make certain that the mounting elements or mounting construction supports at least four times the weight of the device with or without mounting system.
- ↪ Have the appropriate tools at the ready and mount the safety sensor.
- ↪ Install protective enclosures or safety bars if the safety sensor is in an exposed position.
- ↪ If there is a risk that the safety sensor will be used as a climbing aid, install a suitable physical cover over the safety sensor.

- ↪ Align the mounted safety sensor horizontally and vertically using the integrated electronic spirit level.
 - For the electronic spirit level to work, the supply voltage of 24 V must be present at the safety sensor.
 - The electronic spirit level indicates the vertical (V) and horizontal (H) alignment of the safety sensor. The spirit level is displayed
 - permanently after the end of the booting phase/start phase when starting without configuration
 - repeatedly until the end of the booting phase/start phase when starting with configuration
 - using the configuration and diagnostic software:
 - Diagnosis >** [Align sensor mechanically] button ()
 - When mounting without a mounting system, the safety sensor can be aligned only slightly along the horizontal axis.
- ↪ Attach safety notice stickers to the mounted safety sensor (the stickers are included in the delivery contents).
- ↪ Configure the safety sensor with the configuration and diagnostic software; see chapter 9 "Configuring the safety sensor".
 - Observe the information on the response times, the stopping time of the machine and the protective field dimensioning for your application.
 - Determine the size of the protective field on the basis of the mounting location, the calculated safety distances and additional distances.

NOTICE

With protective field boundaries <200 mm, object detection may be restricted owing to the measurement error.

- ↪ When defining the protective field, take into account the additional distance Z_{sm} to the protective field contour (see chapter 7.2 "Stationary danger zone guarding").

- Configure the protective field so that the safety-related switching outputs are switched off from every accessible point with sufficient minimum distance D .
- Determine the start-up/restart operating mode required for the application.
- If you are using start and/or restart interlock, determine the position for the reset button.
- Many safety-relevant parameters are preset for each application in the configuration and diagnostic software. Use these preset values where possible.
- ↪ Create a record document for the device configuration and protective field dimensioning.
 - The document must be signed by the person responsible for the configuration.
 - Include this document with the machine documentation.
- ↪ Mark the protective field boundaries on the floor.
 - You can easily test the safety sensor along this marking.

After mounting, you can electrically connect (see chapter 8 "Electrical connection"), start up, align (see chapter 10 "Starting up the device"), and test (see chapter 11 "Testing") the safety sensor.

7.1.4 Mounting examples

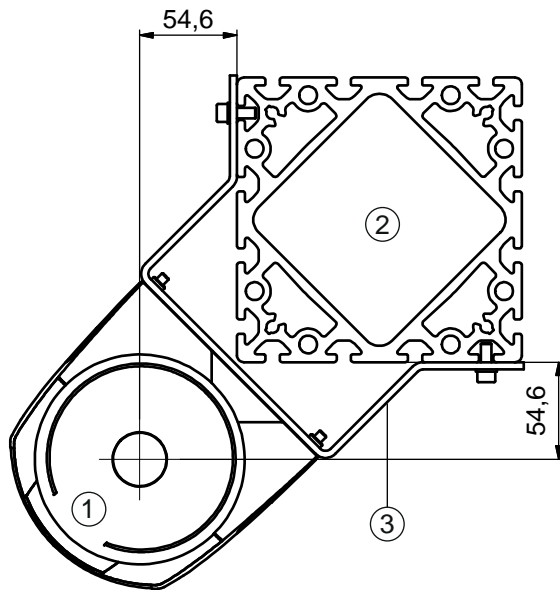

- all dimensions in mm
- 1 Safety sensor
 - 2 Column
 - 3 BT856M mounting bracket

Fig. 7.3: Example: mounting on a post

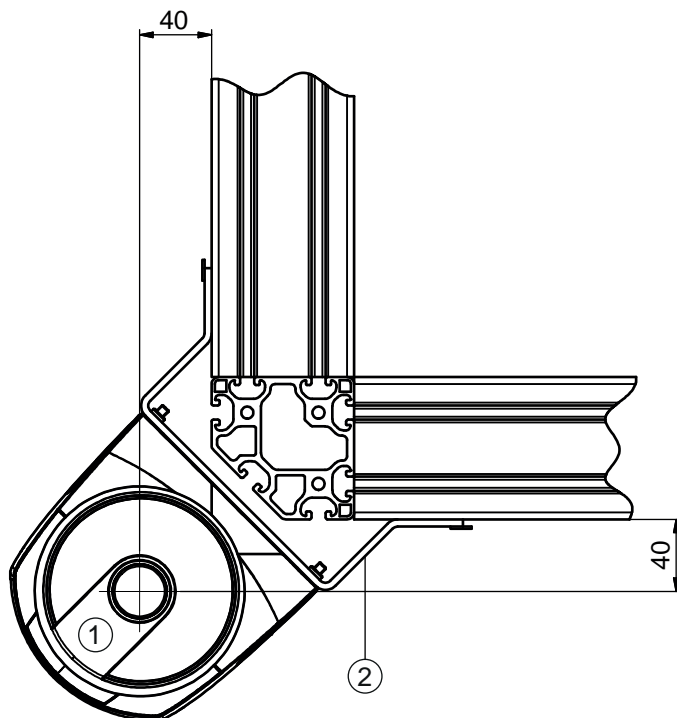

- all dimensions in mm
- 1 Safety sensor
 - 2 BT840M mounting bracket

Fig. 7.4: Example: mounting on a chamfered corner

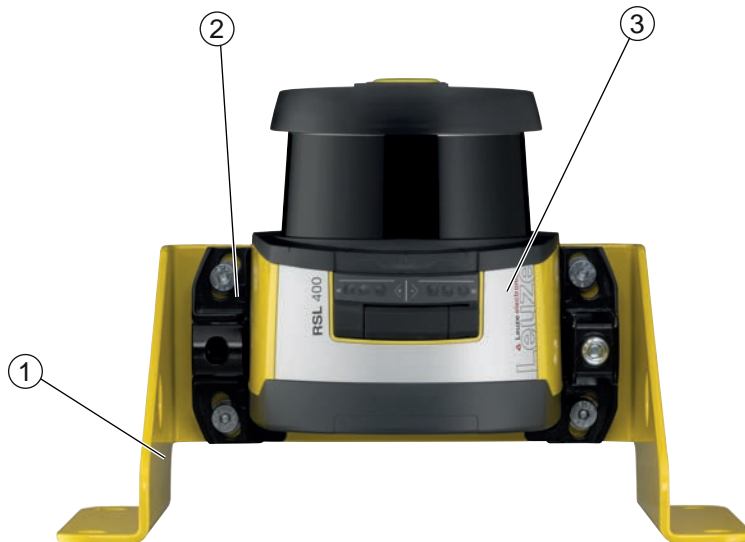

- 1 BTF815M mounting bracket (only in combination with the BTU800M mounting system)
- 2 BTU800M mounting system
- 3 Safety sensor

Fig. 7.5: Example: mounting on floor

7.1.5 Information on protective field dimensioning

NOTICE	
	<p>With protective field boundaries <200 mm, object detection may be restricted owing to the measurement error.</p> <p>↪ When defining the protective field, take into account the additional distance Z_{sm} to the protective field contour (see chapter 7.2 "Stationary danger zone guarding").</p>

- ↪ Dimension the protective field big enough that the safety sensor's switching signal can stop the dangerous movement in good time.
If several protective fields are selected with field pair changeover, this condition applies for all protective fields.
If you cannot sufficiently dimension a protective field, use additional protective measures, e.g. safety guards.
- ↪ Ensure that the protective field cannot be walked behind in the direction of the danger zone.
- ↪ Observe all delay times, e.g. safety sensor response times, control element response times, braking times or machine or automated guided vehicle stopping times (AGV).
- ↪ Take changed delay times, which, for example, can be caused by reducing the braking force, into account.
- ↪ Observe shadowing effects, e.g. surfaces and areas behind static objects. People in the shadows of these objects will not be detected by the safety sensor.
- ↪ Observe the lateral tolerance when dimensioning the protective fields (see chapter 15 "Technical data").
- ↪ Do not use cone-shaped protective field contours, as these do not guarantee any protective function.
- ↪ Take the additional distances required for the application into account.

Handling unmonitored areas

There is an area behind the safety sensor that the safety sensor does not monitor. Unmonitored areas can also materialize, e.g. if you install a safety sensor on a rounded off vehicle front.

It must not be possible to walk behind unmonitored areas.

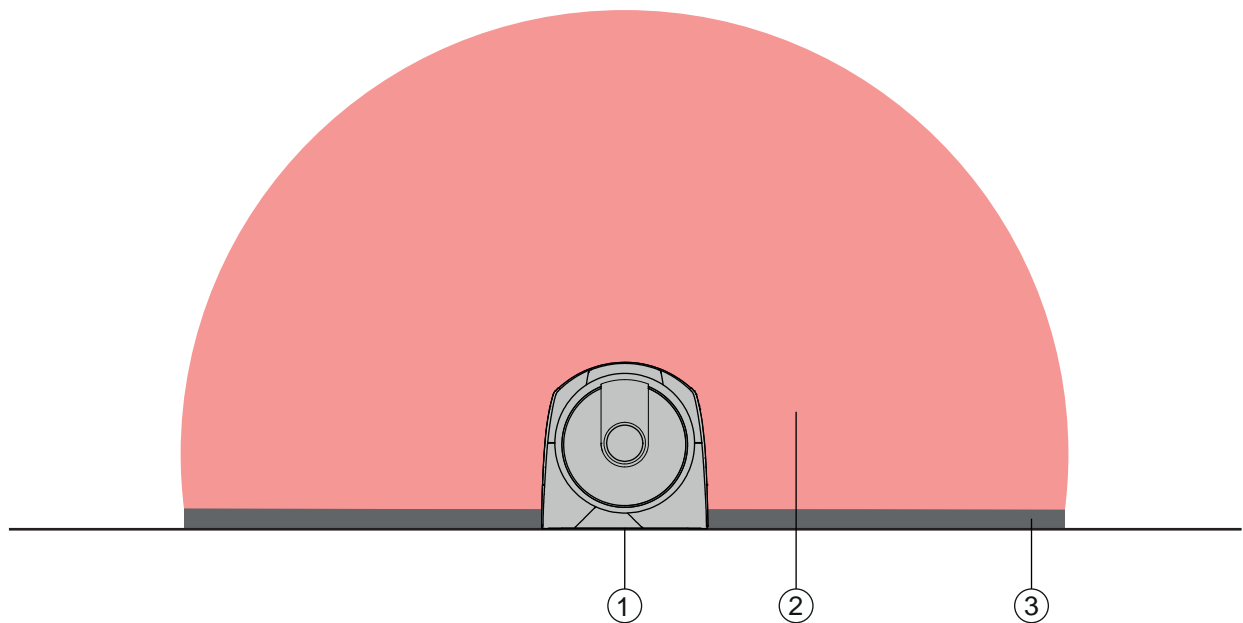

- 1 Safety sensor
- 2 Protective field
- 3 Unmonitored area;
Optimum availability at a distance of 50 mm to fixed contours

Fig. 7.6: Unmonitored area

- ↪ Prevent access to an unmonitored area with screens.
- ↪ Prevent walking behind by countersinking the safety sensor into the machine contour.

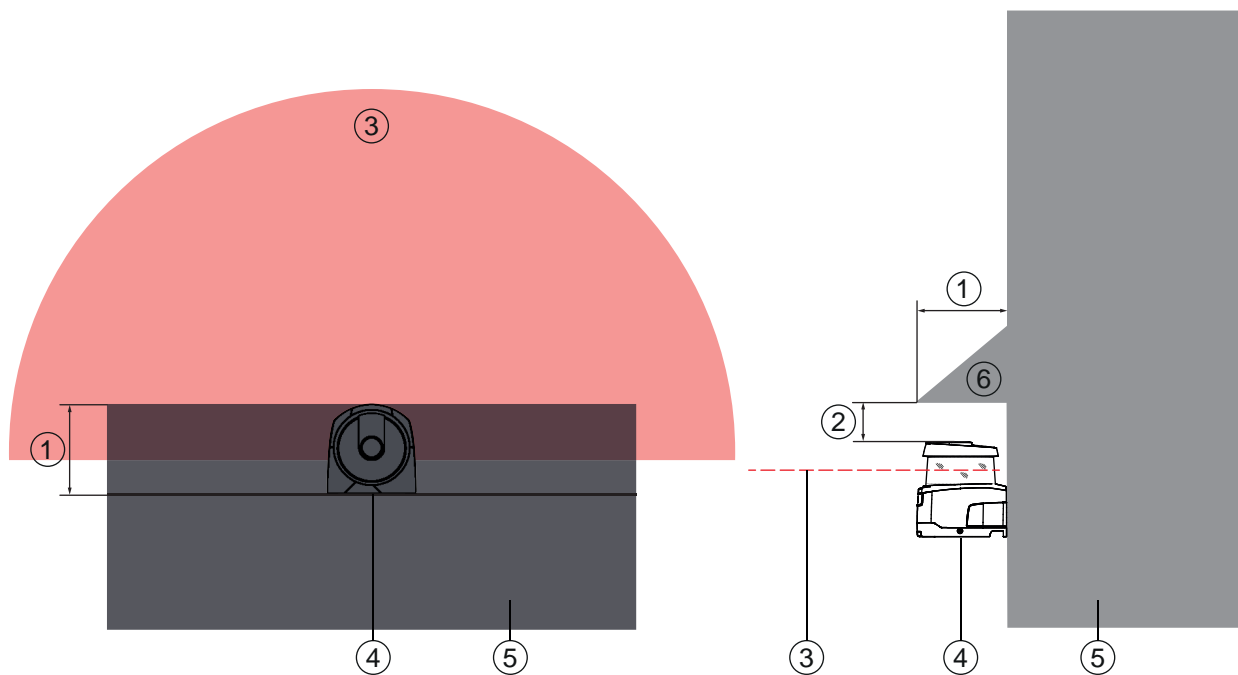

- 1 Countersinking into the machine contour, min. 100 mm
- 2 Minimum distance above the scanner unit, min. 34 mm
- 3 Protective field
- 4 Safety sensor
- 5 Machine
- 6 Angled physical cover

Fig. 7.7: Stepping behind protection by countersinking into the machine contour

- ↪ Use a physical cover set at an angle over the safety sensor if you expect that the safety sensor will be used as a climbing aid or standing surface.

Protective field setup with adjacent safety sensors

The safety sensor has been developed in a way that prevents several safety sensors from interfering with one another as much as possible. Nevertheless, if several safety sensors are positioned adjacent to each other, this may result in a reduction in the availability of the safety sensors.

↪ When mounting the safety sensor, avoid glossy surfaces directly behind the optics cover.

↪ Plan for shielding with stationary applications.

The shielding must be at least as high as the safety sensor's optics cover and embedded with the front housing edge.

If you plan for a shielding that is still within the countersinking in the machine contour, the resolution of the protective fields must not be impaired at any accessible points.

You require the reciprocal shielding with both horizontal and vertical alignment of the protective fields.

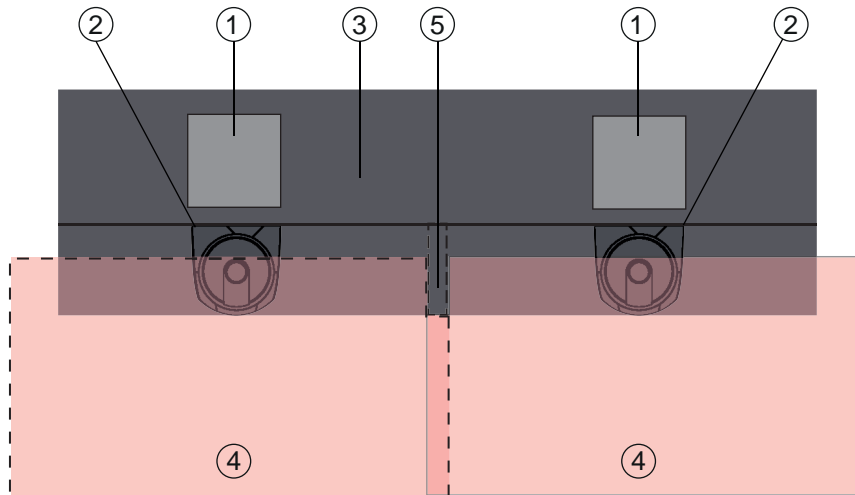

- 1 Point of operation
- 2 Safety sensor
- 3 Machine with countersinking for sensor installation
- 4 Protective fields
- 5 Shielding

Fig. 7.8: Shielding prevents reciprocal influencing of safety sensors set up beside one another

↪ Install the safety sensors off-set on the height.

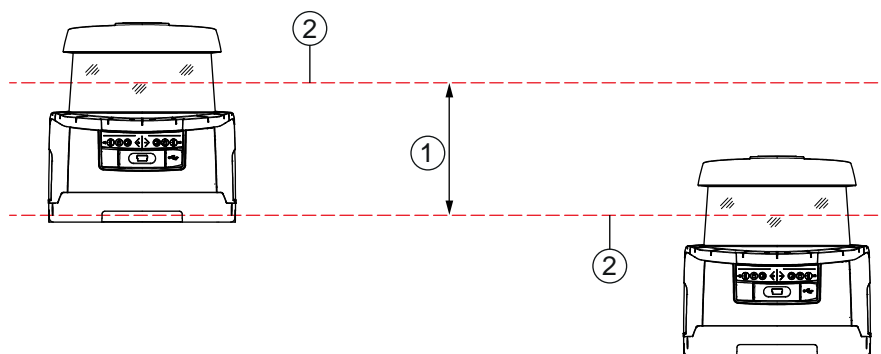

- 1 Minimum distance, min. 100 mm
- 2 Scan level

Fig. 7.9: Height offset mounting, parallel alignment

↪ Install the safety sensors with crossed alignment.

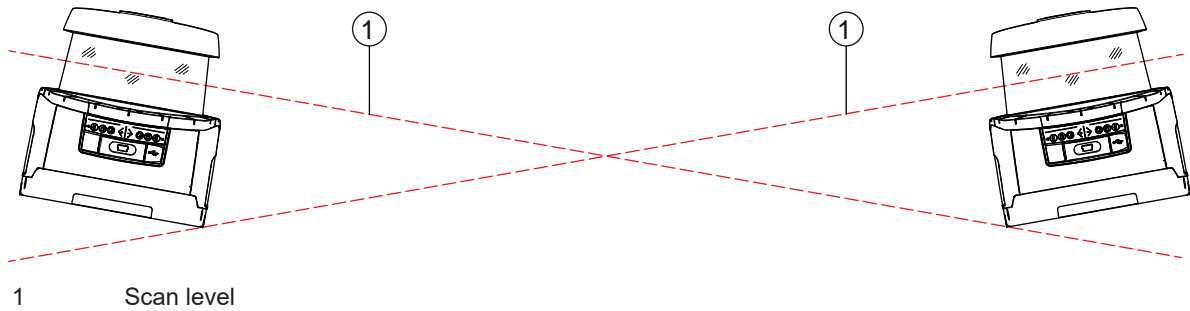

Fig. 7.10: Mounting beside one another, without height offset, crossed alignment

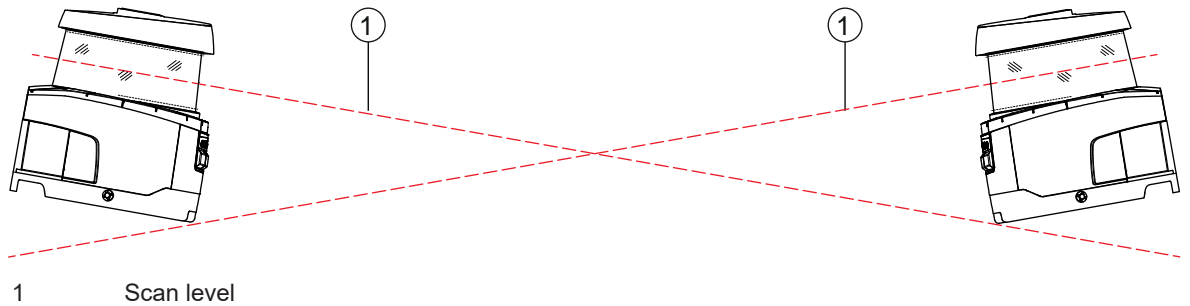

Fig. 7.11: Mutually opposing mounting, without height offset, crossed alignment

7.2 Stationary danger zone guarding

The safety sensor takes over the stop-activating and presence-detecting function.

Calculation of safety distance S for parallel approach to the protective field

$$S = K \cdot T + C$$

S_{RO}	[mm]	= Safety distance
K	[mm/s]	= Approach speed for danger zone guarding with approach direction parallel to the protective field (resolution up to 90 mm): 1600 mm/s
T	[s]	= Total time of the delay, sum from ($t_a + t_i + t_m$)
t_a	[s]	= Response time of the protective device
t_i	[s]	= Response time of the safety relay
t_m	[s]	= Stopping time of the machine
C	[mm]	Additional distance for danger zone guarding with approach reaction H = height of the protective field, H_{min} = minimum installation height permitted, but no smaller than 0, d = resolution of the protective device $C = 1200 \text{ mm} - 0.4 \times H$; $H_{min} = 15 \times (d - 50)$

Response times, stopping time of the machine

The safety sensor's rotary mirror rotates on its own axis every 40 ms. One revolution is a scan. At least two consecutive scans must be interrupted so that the safety-related switching outputs switch off. The safety sensor's minimum response time is therefore 80 ms.

If you want to increase the safety sensor's availability in an environment with fine particles, increase the number of interrupted scans after which the safety-related switching outputs switch off. With each additional scan the response time t_a increases by 40 ms. With $K = 1600 \text{ mm/s}$ the safety distance increases by 64 mm per additional scan.

- ↪ Select a response time t_a of at least 120 ms or higher.
- ↪ Determine the machine/system's stopping time t_m .
If data is not available, you can commission Leuze to perform measurements; see chapter 14 "Service and support".
- ↪ If an increase in the stopping time within the regular test periods is to be expected, take an additional time into account for the machine's stopping time t_m .

Additional distance C for danger zone guarding with approach reaction

You prevent reaching the point of operation by reaching over with the additional distance C:

$$C = 1200 - 0,4 \cdot H$$

- H [mm] = Height of protective field above floor (installation height)
- C_{MIN} [mm] = 850 mm
- H_{MAX} [mm] = 1000 mm

The minimum permissible installation height depends on the resolution of the safety sensor:

Tab. 7.2: Additional distance C depending on the resolution of the safety sensor

Safety sensor resolution (mm)	Minimum permissible installation height (mm)	Additional distance C (mm)
50	0	1200
70	300	1080

Application-related additional distances for safety distance S

The protective field boundaries must be defined so that the calculated safety distance S to the point of operation, extended by the additional distances, is complied with everywhere. Where this is not possible or does not make sense, you can use hard guards as supplementary measures.

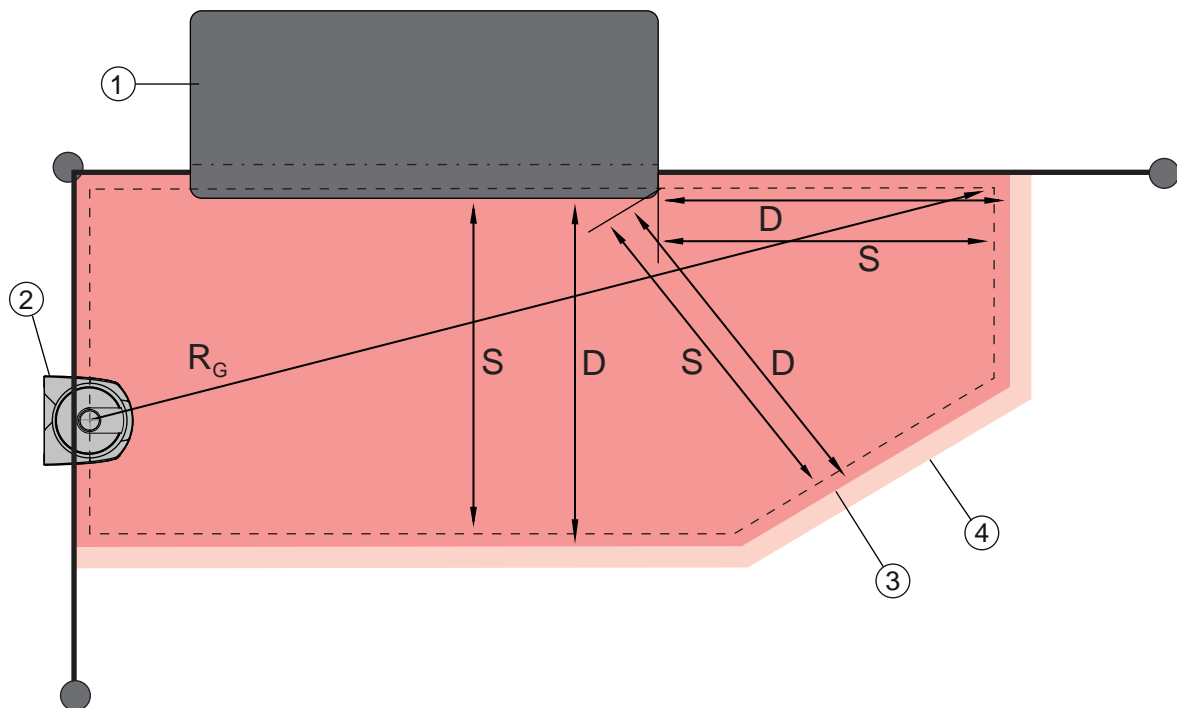

- 1 Routing machine with free space for sensor protective field in the area under the machine table
- 2 Safety sensor
- 3 Protective field contour
- 4 Warning field contour
- S Calculated safety distance S
- D Minimum distance D (= safety distance S + additional distance Z_{SM} + Z_{REFL}, where required)
- R_G Largest protective field radius without additional distances, measured from the rotation axis of the rotary mirror

Fig. 7.12: Defining the protective field contour for a stationary, horizontal protective field

- ↪ Define the limits of the protective field using the safety distance S without an additional distance.
- ↪ Determine the biggest protective field radius R_G for this protective field.
The biggest protective field radius determines the additional distance Z_{SM} for the system-related measurement error, by which the protective field contour must be enlarged.
The position of the rotary mirror's center point with regard to the housing is provided by the dimensioned drawings.

Tab. 7.3: Additional distance Z_{SM} for the protective field contour because of measurement error

Biggest protective field radius R_G without additional distances	Additional distance Z_{SM}
< 6.25 m	100 mm
> 6.25 m	120 mm

- ↪ Avoid retro-reflectors at the scan level beyond the protective field boundaries. If this is not possible, add another additional distance Z_{REFL} of **100 mm**.

Minimum distance D to the protective field contour

The minimum distance D is the distance between point of operation and protective field contour.

$$D = S + Z_{SM} + Z_{REFL}$$

- D [mm] = Minimum distance between the point of operation and the protective field contour
- Z_{SM} [mm] = Additional distance for system-related measurement error
- Z_{REFL} [mm] = Additional distance for retro-reflectors

- ↪ If the protective field runs up against fixed boundaries, such as walls or machine frames, take a countersinking into the machine contour of at least the size of the necessary additional distance Z_{SM} , and Z_{REFL} where required, into account. With the protective field contour under these conditions, stay about 50 mm away from the machine surface.
- ↪ If the protective field runs up against hard guards, ensure that the protective field ends under instead of in front of the hard guards. The width of the lower post must correspond with the size of the required additional distances.
- ↪ If all hazards in the fenced off area are covered by the safety sensor and the height of the scan level is 300 mm, you can raise the bottom edge of the hard guards from 200 mm to 350 mm in the protective field range. The protective field reaching to under the hard guards takes over the protective function of preventing an adult from crawling under in this case.

NOTICE	
	The scan level of the safety sensor is level with the alphanumeric display.

- ↪ Prevent obstructions within the calculated protective field boundaries. If this is not possible, implement protective measures so that the point of operation cannot be reached from out of the shadow of the obstruction.

7.3 Stationary point of operation guarding

The safety sensor takes over the stop-activating and presence-detecting function.

Calculation of safety distance S_{RO} for access over the vertical protective field

$$S_{RO} = K \cdot T + C_{RO}$$

S_{RO}	[mm]	= Safety distance
K	[mm/s]	= Approach speed for point of operation guarding with approach reaction and normal approach direction to the protective field (resolution 14 to 40 mm): 2000 mm/s or 1600 mm/s, when $S_{RO} > 500$ mm
T	[s]	= Total time of the delay, sum from ($t_a + t_i + t_m$)
t_a	[s]	= Response time of the protective device
t_i	[s]	= Response time of the safety relay
t_m	[s]	= Stopping time of the machine
C_{RO}	[mm]	= Additional distance in which a body part can move towards the protective device before the protective device triggers

Response times, stopping time of the machine

The safety sensor's rotary mirror rotates on its own axis every 40 ms. One revolution is a scan. With each additional scan the response time t_a increases by 40 ms. With $K = 2000$ mm/s approach speed this corresponds with an increase in the safety distance of 80 mm per additional scan. With $K = 1600$ mm/s it is 64 mm.

- ↳ Select a response time t_a of at least 80 ms or higher.
- ↳ Determine the machine/system's stopping time t_m .
If data is not available, you can commission Leuze to perform measurements (see chapter 14 "Service and support").
- ↳ If an increase in the stopping time within the regular test periods is to be expected, take an additional time into account for the machine's stopping time t_m .

Additional distance C_{RO} for finger protection

The required finger protection is ensured here by an additional distance C, which depends on the safety sensor resolution, in addition to the safety distance.

- Detection of an adult's hand:
 - Resolution: 30 mm
 - Additional distance C_{RO} : 128 mm
- Arm detection:
 - Resolution: 40 mm
 - Additional distance C_{RO} : 208 mm

Protective field contour and reference contour

With a vertical protective field, you must define at least two sides of the protective field contour as reference contour. The objective is to monitor the position of the protective field with regard to its marginal area. If the arrangement misaligns and the distance of the safety sensor to the reference surface changes as a result, switch the safety-related switching outputs off.

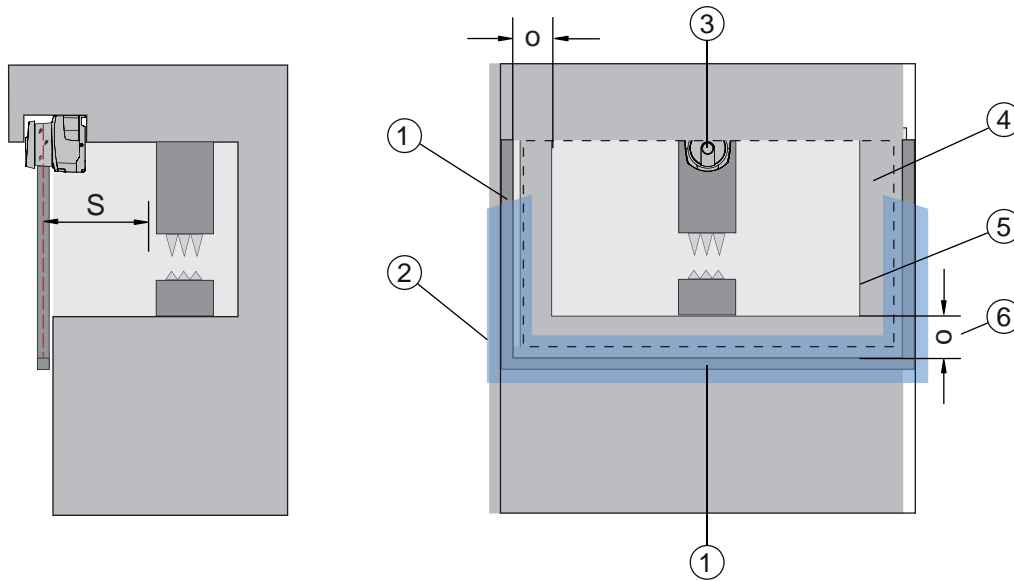

- 1 Physical frame for reference contour
- 2 Reference contour, must cover at least two sides of the protective field
- 3 Safety sensor
- 4 Protective field
- 5 Machine opening contour
- 6 Overlap o of the protective field via the machine opening towards the reference contour frame

Fig. 7.13: Defining the protective field contour and reference contour, stationary point of operation guarding, vertical protective field

	WARNING
	<p>Risk of injury caused by undetected reaching through at side!</p> <p>↳ Depending on the selected resolution and the arrangement of the safety laser scanner, a suitable overlap of the protective field over the protected opening must be selected in order to prevent undetected reaching through at the side.</p>

7.4 Stationary access guarding

The vertical protective field used for access guarding only detects people during passage through. After a person has passed through, a start/restart interlock must ensure that the dangerous movement does not start again automatically.

$$S_{RT} = K \cdot T + C_{RT}$$

- S_{RT} [mm] = Safety distance
- K [mm/s] = Approach speed for access guarding with approach direction orthogonal to the protective field: 2000 mm/s or 1600 mm/s, when $S_{RT} > 500$ mm
- T [s] = Total time of the delay, sum from $(t_a + t_i + t_m)$
- t_a [s] = Response time of the protective device, max. 80 ms
- t_i [s] = Response time of the safety relay
- t_m [s] = Stopping time of the machine
- C_{RT} [mm] = Additional distance for access guarding with approach reaction with resolutions of 14 to 40 mm, $d =$ resolution of protective device $C_{RT} = 8 \times (d - 14)$ mm. Additional distance for access guarding for resolutions > 40 mm: $C_{RT} = 850$ mm (standard value for arm length)

Response times, stopping time of the machine

The safety sensor's rotary mirror rotates on its own axis every 40 ms. One revolution is a scan. With each additional scan the response time t_a increases by 40 ms. With $K = 2000$ mm/s approach speed this corresponds with an increase in the safety distance of 80 mm per additional scan. With $K = 1600$ mm/s it is 64 mm.

- ↪ Select a response time t_a of 80 ms.
Never define a value higher than 80 ms for t_a for access guarding or passage controls. With higher values it can happen that a person might not be detected when passing through the protective field with an approach speed of 1600 mm/s.
- ↪ Determine the machine/system's stopping time t_m .
If data is not available, you can commission Leuze to perform measurements (see chapter 14 "Service and support").
- ↪ If an increase in the stopping time within the regular test periods is to be expected, take an additional time into account for the machine's stopping time t_m .

Additional distance C_{RT} for finger protection



The required finger protection is ensured here by an additional distance C , which depends on the safety sensor resolution, in addition to the safety distance.

- Detection of an adult's hand:
 - Resolution: 30 mm
 - Additional distance C_{RT} : 128 mm
- Arm detection:
 - Resolution: 40 mm
 - Additional distance C_{RT} : 208 mm

Protective field contour and reference contour

With a vertical protective field, you must define at least two sides of the protective field contour as reference contour. The objective is to monitor the position of the protective field with regard to its marginal area. If the arrangement misaligns and the distance of the safety sensor to the reference surface changes as a result, switch the safety-related switching outputs off.

- ↪ When defining the protective field ensure that there are no gaps bigger than 150 mm.
- ↪ When defining the protective field boundaries, specify the sectors that monitor the position of the protective field as reference contour.

	WARNING
	<p>Risk of injury caused by undetected reaching through at side!</p> <p>↪ Depending on the selected resolution and the arrangement of the safety laser scanner, a suitable overlap of the protective field over the protected opening must be selected in order to prevent undetected reaching through at the side.</p>

7.5 Mobile danger zone guarding on AGVs

Danger zone guarding protects people and objects that are in rooms in which vehicles move in, e.g. automated guided vehicle systems.

A horizontally arranged protective field protects people and objects that are in the vehicle's path and are detected by the front edge of the protective field.

WARNING	
	<p>Danger of injury because of insufficient vehicle stopping distance</p> <p>↪ The operator of the machine must use organizing measures to prevent people from entering the protective field of the vehicle from the sides or being able to move towards an approaching vehicle.</p>

- ↪ Only use the safety sensor on vehicles with electrical drive and electrically influenced drive and braking devices.
- ↪ Only install the safety sensor on the front of the vehicle.
If you must also guard the reverse travel, you must also install a safety sensor on the rear of the vehicle.
- ↪ Mount the safety sensor on the vehicle so that there are no unmonitored areas ≥ 70 mm between the protective field and vehicle front.
- ↪ Set the mounting height such that the scan level is not more than 200 mm above the floor.
A person lying on the floor can therefore be safely detected. This is required by standard EN ISO 3691-4 "Industrial trucks – Safety requirements and verification – Part 4: Driverless industrial trucks and their systems".

NOTICE	
	<p>The scan level of the safety sensor is level with the alphanumeric display.</p>

7.5.1 Minimum distance D

$$D = D_A + Z_{Ges}$$

- D [mm] = Minimum distance, vehicle front (danger) to protective field front edge
- D_A [mm] = Stopping distance
- Z_{TOT} [mm] = Sum of required additional distances

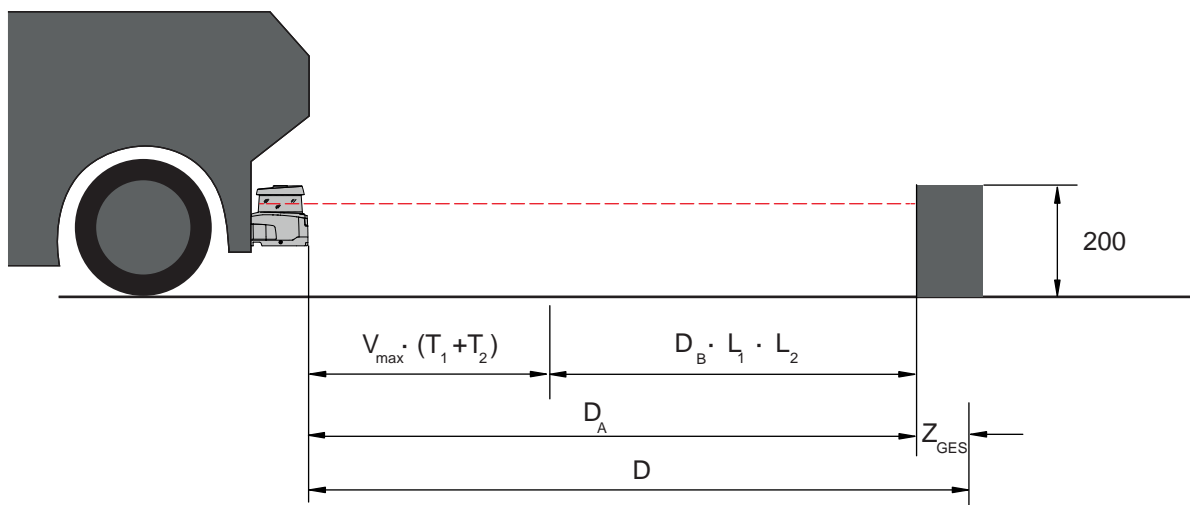

Fig. 7.14: Mobile danger zone guarding, calculation of required minimum distance D

Stopping distance D_A

$$D_A = v_{max} \cdot (T_1 + T_2) + D_B \cdot L_1 \cdot L_2$$

D_A	[mm]	= Stopping distance
v_{max}	[mm/s]	= Maximum vehicle speed
T_1	[s]	= Response time of the safety sensor
T_2	[s]	= Response time of the AGV
D_B	[mm]	= Braking distance with v_{max} and maximum vehicle load
L_1	[---]	= Factor for brake wear
L_2	[---]	= -Factor for problematic floor conditions, e.g. dirt, wet conditions

Additional distances Z

$$Z_{Ges} = Z_{SM} + Z_F + Z_{REFL}$$

Z_{tot}	[mm]	= Total of the required additional distances
Z_{SM}	[mm]	= Additional distance for system-related measurement error, see chapter 7.2 "Stationary danger zone guarding"
Z_F	[mm]	= Additional distance required with lack of floor space H_F
Z_{REFL}	[mm]	= Additional distance required with retro-reflectors beyond the protective field boundaries; $Z_{REFL} = 100$ mm

The **additional distance Z_{SM}** is always required. Its size depends on the biggest radius R_G from the safety sensor mirror's rotary axis to the protective field boundary without Z_{Tot} . The position of the rotary mirror axis depends on the installation situation.

If the distance between the vehicle and the ground (**ground clearance H_F**) is less than 120 mm, there is a risk of parts of the foot becoming trapped underneath the vehicle before the vehicle comes to a standstill when the person above the foot is detected. An additional **distance Z_F** to the protective field, which is determined according to the following diagram, is required:

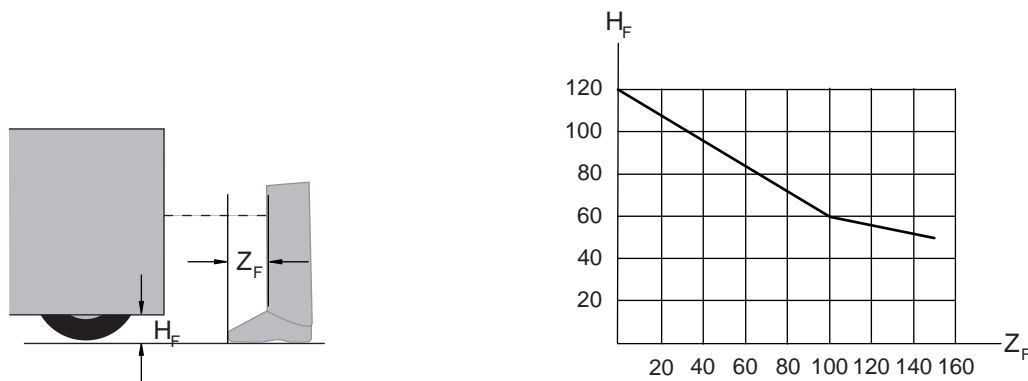
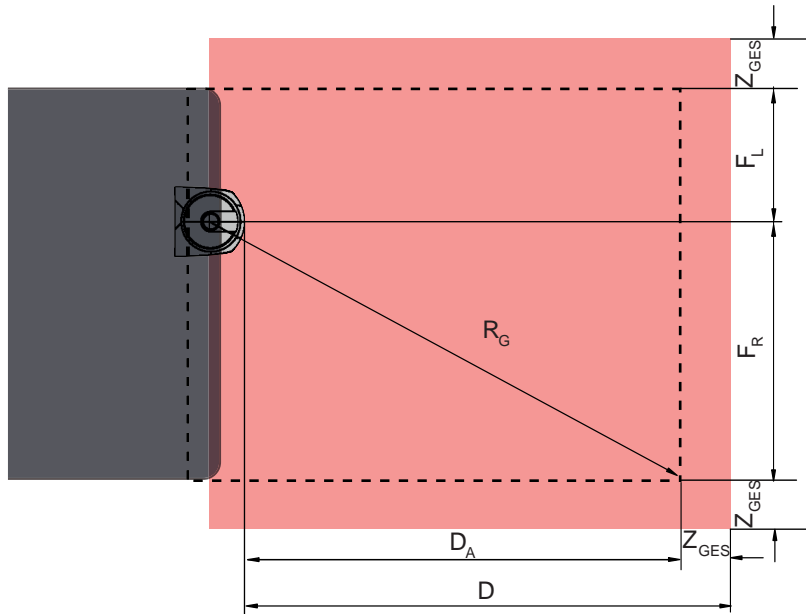

Fig. 7.15: Diagram for determining the additional distance Z_F with lack of floor space H_F
 With a vehicle height of less than 50 mm, an additional distance Z_F of 150 mm is always required.
 If wheels are mounted near the side wall, always add an additional distance $Z_F > 150$ mm.

7.5.2 Protective field dimensions



- D Minimum distance, vehicle front (danger) to protective field front edge
- D_A Stopping distance
- Z_{TOT} Total required additional distances to the front and for both sides
- F_L Distance from safety sensor center to left vehicle edge
- F_R Distance from safety sensor center to right vehicle edge
- R_G Biggest radius in the protective field without Z_{TOT} for determining the additional distance Z_{SM}

Fig. 7.16: Mobile danger zone guarding, dimensions for horizontal protective field

- ↪ Select 70 mm resolution.
- ↪ Set the protective field length so that the response time until braking and the braking distance, including factors for wear and tear and floor conditions, and any necessary additional distances are taken into account.
- ↪ Arrange the protective field symmetrically with reference to the vehicle width, even if the safety sensor is not arranged centered.
- ↪ Configure an upstream warning field that reduces the vehicle's speed.
A full brake with a subsequent interruption of the protective field is then executed moderately and is less demanding on the vehicle's drives.
Dimension the minimum distance D for the maximum speed as if the speed reduction initiated by the warning field had not happened.
- ↪ Take the required free space for lateral protrude protective fields under the roller conveyors along the transportation path into account.
- ↪ If you have to expect angular deviations of the vehicle during the travel, plan an additional tolerance area to guarantee undisturbed travel operation.

7.6 Mobile side guarding on AGVs

WARNING	
	<p>Danger of injury because of insufficient vehicle stopping distance</p> <p>↪ The operator of the machine must use organizing measures to ensure that people cannot enter the vehicle's protective field from the side.</p>

- ↪ For mobile vertical protective fields use a resolution of at least 150 mm.
- ↪ Position the protective field edges in the travel direction in accordance with the front protective field edge of the horizontal protective field.
- ↪ Ensure that the response times of all components of the switch-off circuit are the same or balance the response times with different protective field dimensioning.
- ↪ Set the vertical protective fields at a slight angle so that the lower protective field edges protrude over the vehicle width by the amount of the additional distances, Z_{SM} , Z_F and Z_{REFL} where required; see chapter 7.5.2 "Protective field dimensions".

7.7 Mounting accessories

7.7.1 Mounting system

Using the mounting system you can adjust the safety sensor horizontally and vertically by ± 10 degrees when mounting.

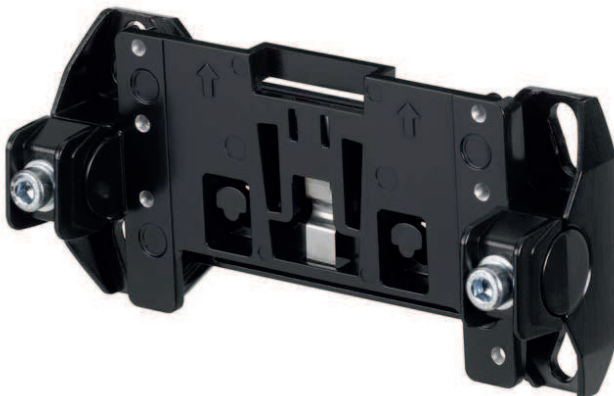



Fig. 7.17: BTU800M mounting system

NOTICE	
	<p>Floor mounting only with mounting system BTU800M</p> <p>↪ The mounting system BTU800M must be used in the case of installation using the mounting bracket for floor mounting.</p>

- ↪ Install the wall mount or mounting bracket for floor mounting on the system side.
- ↪ Mount the mounting system on the wall mount or on the mounting bracket for floor mounting.
- ↪ Attach the safety sensor to the mounting system.
Tightening the screws fixes the safety sensor in position.
- ↪ Align the safety sensor using the integrated electronic spirit level.

7.7.2 Loop guard

The loop guard for the optics cover prevents damage to the safety sensor caused by light contact with foreign objects.

NOTICE	
	The loop guard can only be used together with the mounting system BTU800M.

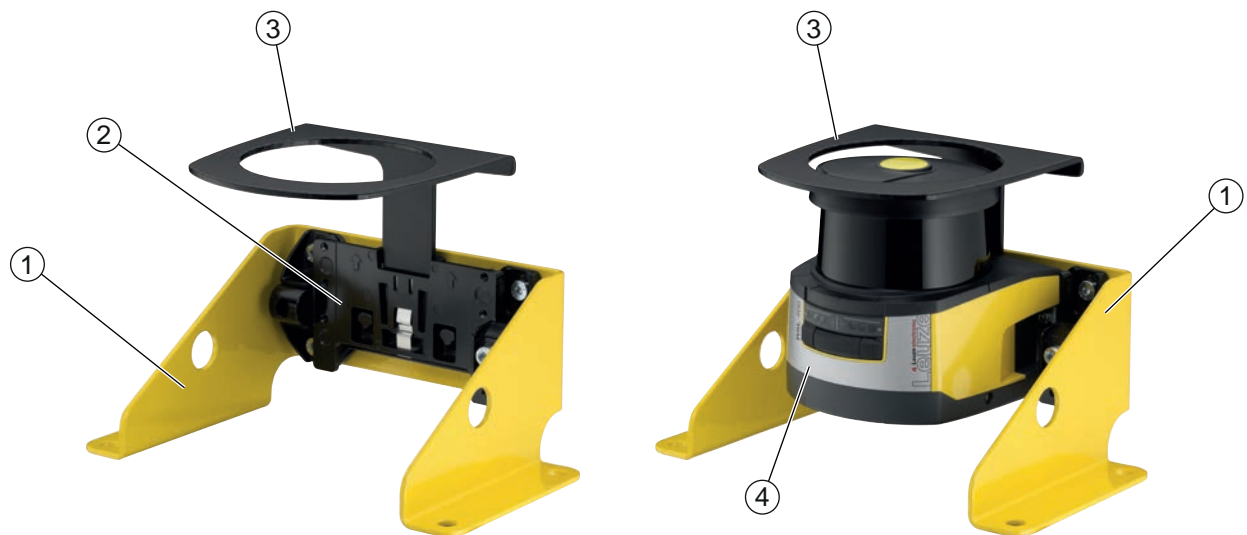







- 1 BTF815M mounting bracket for floor mounting (only with BTU800M mounting system)
- 2 BTU800M mounting system
- 3 Loop guard
- 4 Safety sensor

Fig. 7.18: Loop guard

- ↪ Attach the safety sensor to the mounting system.
- ↪ Engage the loop guard for the optics cover from above into the mounting system.

8 Electrical connection

 WARNING	
	<p>Faulty electrical connection or improper function selection may result in serious injury!</p> <ul style="list-style-type: none"> ↪ Only allow competent persons to perform the electrical connection. ↪ For access guarding, activate the start/restart interlock and make certain that it cannot be unlocked from within the danger zone. ↪ Select the functions so that the safety sensor can be used as intended (see chapter 2.1 "Intended use"). ↪ Select the safety-relevant functions for the safety sensor (see chapter 5.2 "Function modes of safety sensor"). ↪ Always loop both safety-related switching outputs OSSD1 and OSSD2 into the work circuit of the machine. ↪ Signal outputs must not be used for switching safety-relevant signals.
NOTICE	
	<p>Laying cables!</p> <ul style="list-style-type: none"> ↪ Lay all connection cables and signal lines within the electrical installation space or permanently in cable ducts. ↪ Lay the cables and lines so that they are protected against external damages. ↪ For further information: see EN ISO 13849-2, Table D.4.
NOTICE	
	<p>Observe the maximum cable length!</p> <p>Observe the maximum cable lengths as a function of supply voltage and load current (see chapter 8.3 "Connection unit CU308-M12").</p>
NOTICE	
	<p>Observe when wiring with terminals and connectors!</p> <p>In the case of wiring that continues beyond the device or during repairs to connectors, the user must ensure that cables or conductors that have defectively disconnected cannot result in contact with other signals.</p> <ul style="list-style-type: none"> ↪ Use suitable terminals. ↪ Use heat-shrink tubing, wire-end sleeves or similar.
NOTICE	
	<p>Protective Extra Low Voltage (PELV)!</p> <p>The device is designed in accordance with protection class III for supply with PELV (Protective Extra-Low Voltage).</p>

8.1 Electrical supply

see chapter 15.1 "General specifications".

Functional earth

NOTICE	
	<p>Always connect the housing of the safety sensor to functional earth or ground!</p> <ul style="list-style-type: none"> ↳ The housing of the safety sensor must always be connected to earth (functional earth) or machine/vehicle ground. ↳ If the safety sensor is attached to a non-conductive material (e.g. a concrete wall), the housing of the safety sensor must be earthed.

- Factory recommendation: Functional earth via a ground strap/braid (low impedance for RF). Connection points for self-tapping screws used for the ground connection are provided and labeled on the bottom of the connection unit (see chapter 8.3 "Connection unit CU308-M12").
- Functional grounding via the shield of the connection cable. For grounding, the shield of the connection cable in the switch cabinet must be connected to earth or machine/vehicle ground.

NOTICE	
	<p>Make sure that potential equalization is provided!</p> <ul style="list-style-type: none"> ↳ If the housing of the safety sensor or the mounting bracket – despite being mounted on a non-conductive material – is connected to metallic parts (even temporarily), you must ensure that the appropriate potential equalization is provided between the switch cabinet and housing potential; e.g. by grounding the Ethernet connection.

8.2 Interfaces

The safety sensor has two interfaces:

- Interface for connection with the control system
- Interface for communication with PC or laptop

Tab. 8.1: Interfaces

Interface	Type	Function
Control	<ul style="list-style-type: none"> • 2 x M12 connector, 5-pin (CU405-2M12) • M12 connector, 8-pin (CU408-M12) • 1 x Sub-D connector, 15-pin (CU411-RS4) 	<ul style="list-style-type: none"> • Power supply • Switching lines and signal lines
Communication	M12 – RJ 45	<p>Configuration interface and data interface:</p> <ul style="list-style-type: none"> • Parameter configuration • Protective field definition and warning field definition • Display of the measurement contour • Diagnosis

The control cable is permanently attached to the connection unit. A protection cap on the connection unit protects the communication interface when no PC is connected.

8.2.1 Pin assignment for control M12

The safety sensor is equipped with a connection cable with a 8-pin M12 connector.

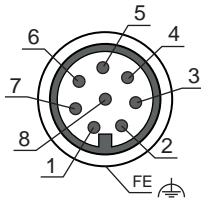

Fig. 8.1: Pin assignment of safety sensor

Tab. 8.2: Pin assignment

Pin	Core color	Signal	Description
1	White	RES1	Start/restart input, protective function A Acknowledgment
2	Brown	UB	Supply voltage
3	Green	EA1	Contacting monitoring OSSD A State signaling, configurable
4	Yellow	A1	State signaling
5	Gray	OSSDA1	Safety-related switching output, protective function A
6	Pink	OSSDA2	Safety-related switching output, protective function A
7	Blue	GND / Ground	Supply voltage ground
8	Red	MELD	Output signal State signaling, configurable
M12 thread		FE	Functional earth, connection cable shield. The shield of the connection cable is on the thread of the M12 plug. The thread is part of the metallic housing.

8.2.2 Pin assignment of M12 Ethernet interface (communication) (D-coded)

The safety sensor is equipped with a 4-pin M12 connector.

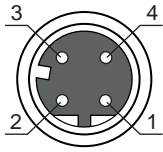



Fig. 8.2: Pin assignment of the Ethernet interface

Tab. 8.3: Pin assignment of the Ethernet interface

PIN	Signal	Description
1	TD+	Data communication, transmission
2	RD+	Data communication, transmission
3	TD-	Data communication, reception
4	RD-	Data communication, reception
FE	GND/shield	Functional earth, communication cable shield. The shield of the inter-connection cable is on the thread of the M12 connector. The thread is part of the metallic housing. The housing is at the same potential as functional earth.

NOTICE



The safety sensor must not be connected to Ethernet cables or Ethernet networks that are laid outdoors.

8.3 Connection unit CU308-M12

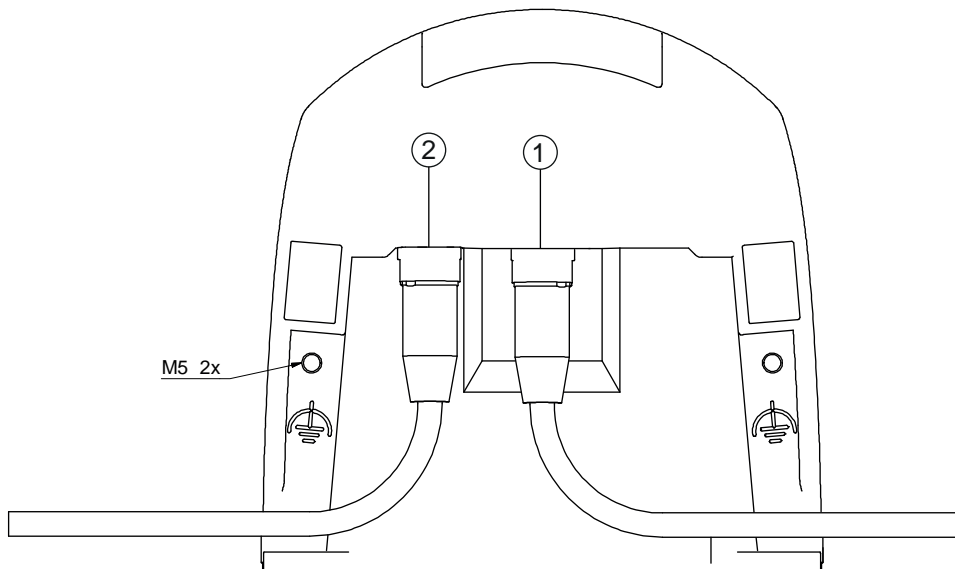

- 1 M12 socket, A-coded, connection to the control
- 2 M12 socket, D-coded, Ethernet communication connection
- M5 Connection for functional earth with M5 x 10 self-cutting/self-tapping (gas tightness) and ground strap

Fig. 8.3: Connection unit CU308-M12

Cable lengths as a function of supply voltage and load current

The maximum cable length is determined by voltage drops on the supply and signal lines.

The following conditions apply for the necessary supply voltage U_B at the input terminals of the connection unit:

- U_B must be greater than the permissible nominal voltage limit of 16.8 V.

NOTICE	
	<p>The recommended supply voltage is at least 19 V!</p> <p>Leuze recommends an supply voltage U_B of at least 19 V at the input terminals of the connection unit.</p> <p>↪ The supply voltage should not be allowed to drop below the recommended value if possible.</p>

- The necessary supply voltage U_B must also ensure the function of the downstream devices.
 - Once the supply voltage U_B has been determined, check whether the resulting signal voltages are sufficient for the downstream devices.
 - Take into account the voltage drops in the safety sensor – up to 3.2 V – and on the signal wiring.

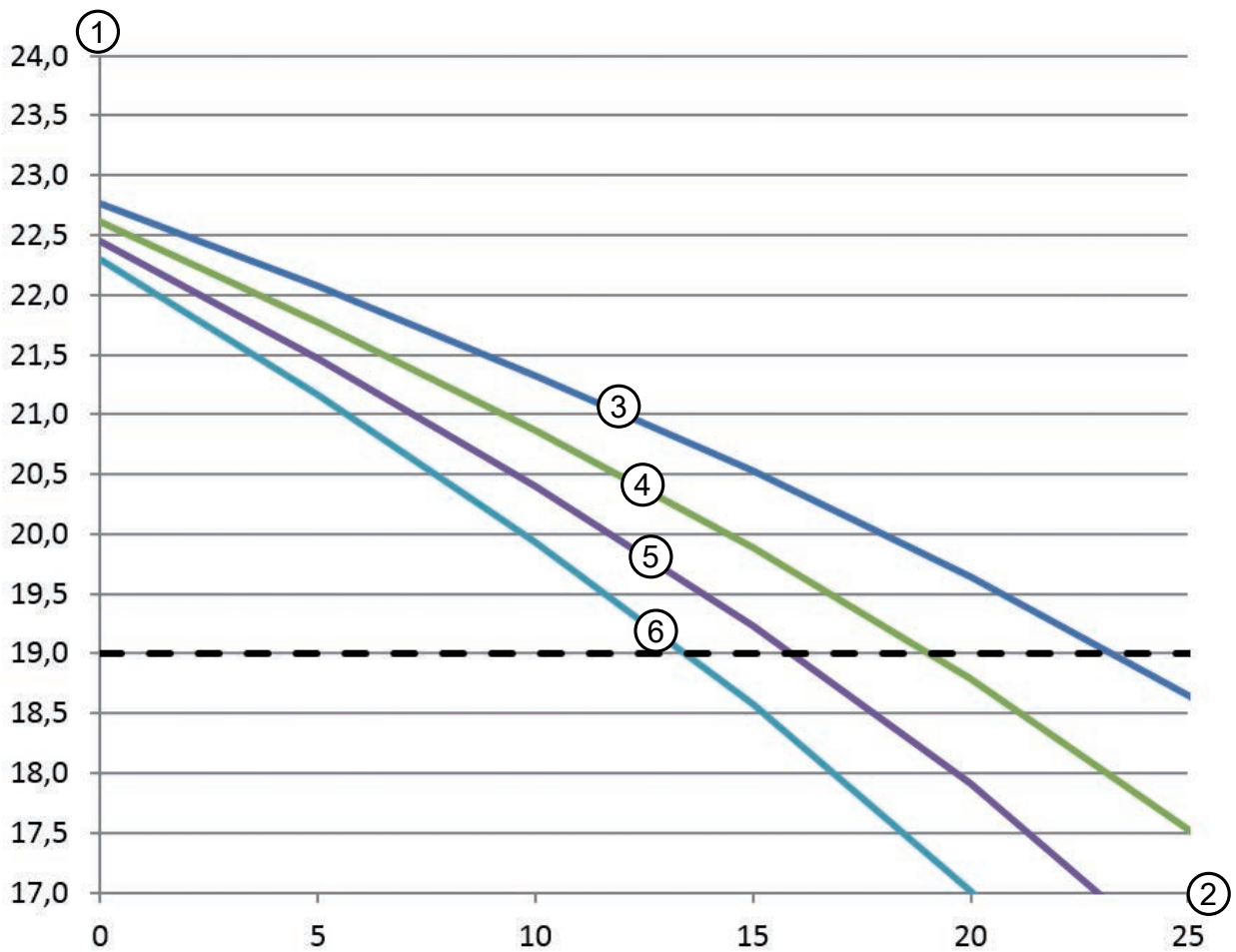

- 1 Supply voltage [V]
- 2 Cable length [m]
- 3 $I_{Load} = 0\text{ A}$
- 4 $I_{Load} = 300\text{ mA}$
- 5 $I_{Load} = 600\text{ mA}$
- 6 $I_{Load} = 900\text{ mA}$

Fig. 8.4: Diagram for estimating the voltage drop on the supply line

- Maximum load current: 0.9 A with 8-pin M12 cable (0.25 mm² / AWG24) for supply and signals

PNP/NPN changeover

The PNP/NPN changeover for signal inputs F1 ... F5, RES1 is performed via a jumper on the connection unit. The reference potential for the signal inputs is set via the jumper:

- P: reference potential +24 V
- N: reference potential 0 V (GND)

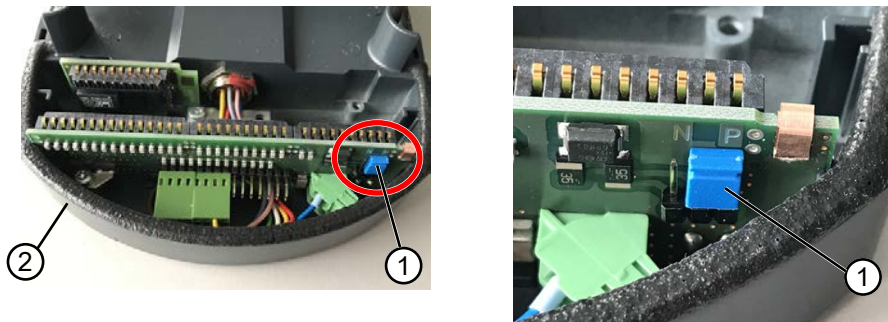

- 1 Jumper
2 Connection unit

Fig. 8.5: Jumper for PNP/NPN changeover

NOTICE



PNP/NPN changeover occurs simultaneously for signals F1 ... F5, RES1.

8.4 Cable lengths according to the supply voltage

The maximum cable length is determined by voltage drops on the supply and signal lines.

The following conditions apply for the necessary supply voltage U_B at the input terminals of the connection unit:

- U_B must be greater than the permissible nominal voltage limit of 16.8 V.

NOTICE



The recommended supply voltage is at least 19 V!

Leuze recommends an supply voltage U_B of at least 19 V at the input terminals of the connection unit.

↪ The supply voltage should not be allowed to drop below the recommended value if possible.

- The necessary supply voltage U_B must also ensure the function of the downstream devices in the case of a linear configuration.

8.5 Circuit diagram example

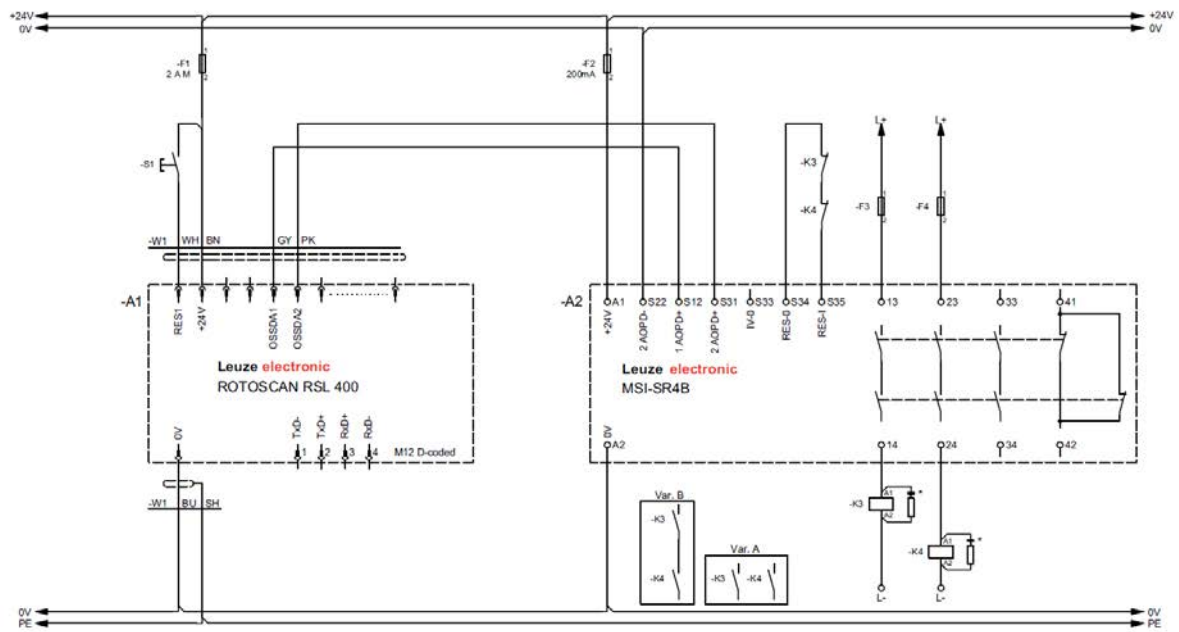

* Spark extinction circuit, suitable spark extinction provided

Fig. 8.6: RSL 311 with MSI-SR4B safety relay





9 Configuring the safety sensor

To start up the safety sensor in your application, the safety sensor must be individually adapted using the software. All configuration data is defined using the configuration and diagnostic software.

General procedure for configuring safety sensor

- ↳ Assessing the risk
 - The system has been determined and its boundaries defined.
 - The safety sensor has been selected as the safety component.
 - The type of guarding has been determined (danger zone guarding, point of operation guarding, access guarding).
- ↳ Calculating safety distance
 - Shape and size of the protective and warning fields
- ↳ Configuring the safety sensor
 - Configuration and diagnostic software (see chapter 4 "Configuration and diagnostic software Sensor Studio")
 - Determine the configuration project (see chapter 9.3 "Determine the configuration project")
 - Configure the protective function (see chapter 9.4 "Configuring protective function")
- ↳ Checking function (see chapter 11 "Testing")

9.1 Defining safety configuration

	WARNING
	<p>Serious accidents caused by incorrect safety configuration!</p> <p>The protective function of the safety sensor is only ensured if the safety sensor is correctly configured for the intended application.</p> <ul style="list-style-type: none"> ↳ Allow only competent persons to perform safety configuration. ↳ Select the safety configuration so that the safety sensor can be used as intended (see chapter 2.1 "Intended use"). ↳ Select the protective field dimensions and contours according to the safety distance calculated for the application (see chapter 7.1.1 "Calculation of safety distance S"). ↳ Select the parameters of the safety configuration according to your risk analysis. ↳ After start-up, check the function of the safety sensor (see chapter 11.1 "Before the initial start-up and following modifications").
	WARNING
	<p>Additional protection against manipulation when the monitoring time is increased!</p> <p>If the monitoring time is increased to above 5 s or if manipulation protection is deactivated, the system operator must introduce other measures to prevent manipulation.</p> <ul style="list-style-type: none"> ↳ For example, make sure that the distance range in which manipulation is possible cannot be accessed by personnel under normal operating conditions.
NOTICE	
	<p>An indicator error (protective field contour is not as expected or contour points jump back and forth) or a changed display of parameter values indicates, e.g., a faulty transfer of the configuration to the device. Such a configuration must not be used.</p>

NOTICE	
	<p>OSSDs will switch off if no reflection signals are being measured!</p> <p>If the safety sensor is unable to measure any reflection signals in a continuous scanning angle of $\geq 90^\circ$ for a long period of time, the safety-related switching outputs switch off. In certain application types (e.g. in buildings with extremely large distances), the safety sensor may not be able to measure any reflection signals. For such application types, it is possible to set or deactivate the monitoring times.</p> <ul style="list-style-type: none"> ↳ In the CONFIGURATION menu, click the <i>Other</i> option. <ul style="list-style-type: none"> ⇒ The OTHER dialog box opens. ↳ In the PROTECTION AGAINST MANIPULATION dialog box, define the monitoring time according to your specific conditions. <ul style="list-style-type: none"> ⇒ If the parking position is active, there will be no manipulation monitoring.

Prerequisites:

- The safety sensor is mounted (see chapter 7 "Mounting") and connected (see chapter 8 "Electrical connection") correctly.
- Dangerous process is switched off, outputs of the safety sensor are disconnected, and the system is protected against being switched back on.
- The size of the protective field is determined on the basis of the mounting location, the calculated safety distances and additional distances.
- The start/restart operating mode required by the application has been determined.
- The conditions for field pair changeover, if required, have been determined.
- The configuration and diagnostic software for the safety sensor is installed on the PC (see chapter 4.2 "Installing software").

NOTICE	
	<p>Many safety-relevant parameters are preset for each application in the configuration and diagnostic software. Use these preset values where possible.</p>

Procedure

All configuration data is defined using the configuration and diagnostic software.

To configure the safety sensor, proceed as follows:

- ↳ Connect the PC to the safety sensor
- ↳ Start the software
 - Set up communication
 - Determine the configuration project
- ↳ Configure the protective function using the project wizard
 - Protective/warning field configuration
 - Resolution and response time
 - Start-up behavior
 - Contactor monitoring
 - Field pair changeover
- ↳ Save configuration project
- ↳ Transferring a configuration to the safety sensor
- ↳ Create a record document for the device configuration and protective field dimensioning. The document must be signed by the person responsible for the configuration.

To document the configuration, you can create a PDF file of the safety configuration or save the configuration and settings in an *.xml file.

NOTICE

The configuration data is stored in the connection unit of the safety sensor and is therefore also available after replacement or repair of the scanner unit. The configuration data only needs to be transferred again if changes are made to the configuration.

9.2 Connecting safety sensor to PC**9.2.1 Connection via Ethernet cable**

↖ Connect the Ethernet cable to the PC or to the network.

NOTICE

The TCP/IP protocol is used for communication via Ethernet.

9.2.2 Communication between safety sensor and PC

The following communication settings are active when the safety sensor is delivered:

LAN

- DHCP: Obtain IP address automatically

You can change the communication settings on the PC using the configuration and diagnostic software in order to, for example, assign a permanent IP address to the safety sensor in your network.

- ↖ Start the configuration and diagnostic software on your PC.
- ⇒ The **mode selection** of the Project Wizard is displayed.
- ⇒ If the **mode selection** is not shown, click the [Project Wizard] button () in the menu bar of the software to start the project wizard.
- ↖ Select the configuration mode and click [Next].
- ⇒ The **Project Wizard** displays the **device selection** list containing the configurable safety sensors.
- ↖ Select the safety sensor from the device selection list and click [Next].
- ⇒ The initial screen for the configuration project is displayed together with information for identification of the selected safety sensor.
- ↖ In the initial screen, click the **SETTINGS** tab.
- ⇒ The **SETTINGS** menu opens.

Assign permanent IP address

- ↖ Select the menu command **Communication > LAN**.
- ↖ In the **DHCP** dialog box, deactivate the *Obtain IP address automatically* checkbox.
- ↖ In the **CONNECTION SETTINGS** dialog box, enter the IP address information.

NOTICE

If, when switching on the safety sensor, +24 V is present at the RES input, the communication parameters are reset to the default values.

9.3 Determine the configuration project

- ↖ Start the configuration and diagnostic software on your PC.
- ⇒ The **mode selection** of the Project Wizard is displayed.
- ⇒ If the **mode selection** is not shown, click the [Project Wizard] button () in the menu bar of the software to start the project wizard.

NOTICE

i During installation of the software, a user *admin* (without password query) is created so that you can start the software without user identification. If other users are registered (**Tools > User management** in the FDT frame menu), you must log in at the software with a user name and password.

This setting allows you to connect to the safety sensor and to read out, upload, enter or change the safety configuration and all settings using the RSL 400 device DTM. The password for the safety sensor only needs to be entered (i.e. the access level only needs to be changed) when the changes are downloaded to the safety sensor (see chapter 4.5.1 "Selecting access level").

- ↩ Select the configuration mode and click [Next].
- ⇒ The **Project Wizard** shows the list of configurable safety sensors.

NOTICE

i You can use a prepared configuration project as a template and make changes to it. To do so, select the configuration mode *Open a stored project file*.

If you want to load the configuration project currently stored in the safety sensor to the PC, select the configuration mode *Device selection with device scan and establishment of connection (online)*.

- ↩ Select the safety sensor in the **Sensor** list and click OK.
Alternatively, you can select the safety sensor by entering the part number or by specifying the sensor range and the sensor type.
- ⇒ The device manager (DTM) of the safety sensor shows the initial screen for the configuration project.

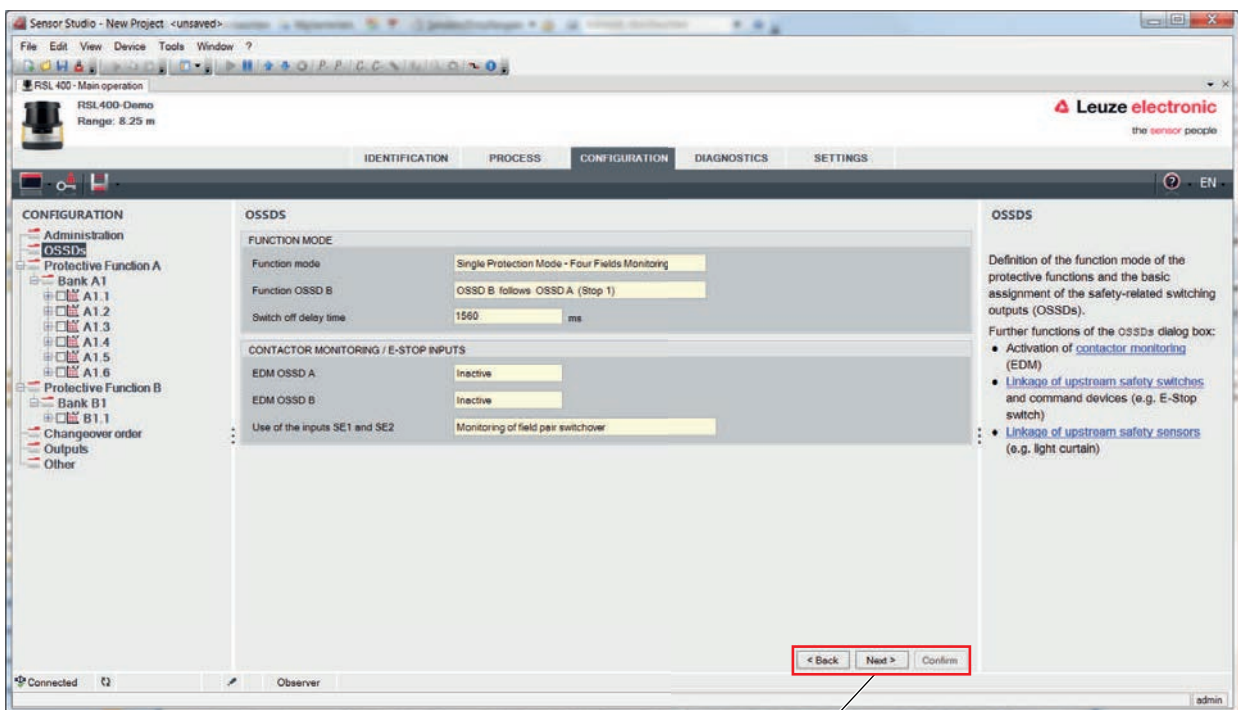

1 Configuration Wizard

Fig. 9.1: Safety configuration using Configuration Wizard

NOTICE

i The device manager (DTM) starts without querying the access level of the user. During communication with the safety sensor, the safety sensor does however query the access level of the user. To change the access levels, see chapter 9.8 "Selecting access level".

9.4 Configuring protective function

Prerequisites: The safety distance, additional distances and protective field dimensions and contours have been determined according to the mounting position (see chapter 7.1.1 "Calculation of safety distance S").

↪ In the initial screen, click the *CONFIGURATION* tab.

⇒ The **CONFIGURATION** menu opens with the options:

- Administration
- *OSSDs*
If the *OSSDs* option is selected in the **CONFIGURATION** menu, the *Protective function A* option is displayed.
- *Outputs*
- *Other*

9.4.1 Creating simple safety configuration

To create a safety configuration for simple commissioning, you must first perform five configuration steps to access the editor used for defining the contours of the protective and warning fields.

By clicking [Next], you can proceed to the next configuration step without selecting the corresponding option in the **CONFIGURATION** menu.

If you make changes to the default settings in a configuration step, first click the [Confirm] button and then [Next].

↪ *Administration*

↪ *OSSDs*

↪ *Protective function A*

↪ *Bank A1*

↪ *Outputs*

9.4.2 Entering administration parameters

↪ In the **CONFIGURATION** menu, click the *Administration* option.

⇒ The **ADMINISTRATION** dialog box opens.

↪ In the input fields, enter the device data and the project data for the configuration project.

9.4.3 Activating protective function and contactor monitoring

↪ In the **CONFIGURATION** menu, click the *OSSDs* option.

⇒ The **OSSDs** dialog box opens.

↪ In the **FUNCTION MODE** list, select the protective function of the safety sensor.

⇒ The *Protective function A* option is shown in the **CONFIGURATION** menu.

NOTICE



The switchable protective/warning field pairs for the selected protective function are defined in configuration banks.

↪ In the **CONTACTOR MONITORING** list, activate the contactor monitoring of the safety sensor:

- EDM OSSD A

NOTICE



The activated contactor monitoring (EDM) is assigned to indication signal output EA1. This signal output is thus disabled for the configuration of the signal outputs.

↪ Click the [Confirm] button.

9.4.4 Creating and configuring protective/warning field pairs

The changeover-capable protective/warning field pairs for the selected protective function are defined in configuration banks. The configuration banks are shown in the navigation tree of the configuration menu as "Bank", e.g. *Bank A1*.

Creating banks

- ↵ In the **CONFIGURATION** menu, click the *Protective function A* option.
- ⇒ The **PROTECTIVE FUNCTION A** dialog box opens.
- ↵ Enter the description of the protective function in the input field.
- ↵ In the **CONFIGURATION** menu, right-click the *Protective function A* option.
Select *Add configuration bank*.
- ⇒ The **Add bank** dialog box opens.
- ↵ In the **Bank** list, select the number of the bank and click the [Add] button.
When you have added all banks for the protective function, click [Close].
- ⇒ The *Bank 1* option is shown under *Protective function A* in the **CONFIGURATION** menu.

Configuring banks

The resolution for hand, leg or body detection, the response time and start-up behavior of the safety sensor and the field pair changeover for the protective/warning field pairs are configured via the banks.

NOTICE	
	For resolution, response time and AGV speed, select the values that you used for calculating the safety distances and additional distances for the application assigned to the configuration bank.

- ↵ In the **CONFIGURATION** menu, select the bank the configuration of which you want to define.
- ⇒ The **RESOLUTION**, **RESPONSE TIME** and **START-UP BEHAVIOR** dialog boxes are displayed.
- ↵ In the **RESOLUTION** dialog box, enter the resolution and, if applicable, the maximum speed of an automated guided vehicle (AGV) in the input fields.

NOTICE	
	If in the <i>Resolution</i> and <i>Max. AGV speed</i> input fields you select values > 0, the application usually used for the bank is displayed in the <i>Application</i> field, e.g. <i>Point of operation guarding</i> . For access guarding, point of operation guarding and danger zone guarding, you must select <i>Max. AGV speed = 0!</i>

- ↵ In the **RESPONSE TIME** dialog box, select the response time of the safety sensor.
- ↵ In the **START-UP BEHAVIOR** dialog box, select the start-up behavior and the restart time of the safety sensor.

NOTICE	
	Configuration of the start-up behavior is only implemented if the corresponding electrical signal connections exist; see chapter 8 "Electrical connection".

NOTICE	
	When the safety sensor is configured, the set restart time should correspond to at least the selected response time.

- ↵ Click the [Confirm] button.
- ↵ Configure all other banks of the protective function following the described procedure.

Create protective and warning fields

A field pair consists of one protective field and one warning field.

- ↪ In the **CONFIGURATION** menu, right-click the *Bank 1* option under *Protective function_A*. Select *Add field pair*.
- ⇒ The **Add field pair** dialog box opens.
- ↪ In the **Field pair** list, select the number of the field pair and click the [Add] button. When you have added all field pairs for the bank, click [Close].
- ⇒ The added field pairs are shown in the **CONFIGURATION** menu as an option under *Bank 1* under *Protective function_A*. The *Parameters* option is displayed for each field pair.

Configure protective and warning fields

Defining contours and boundaries for protective field and warning field

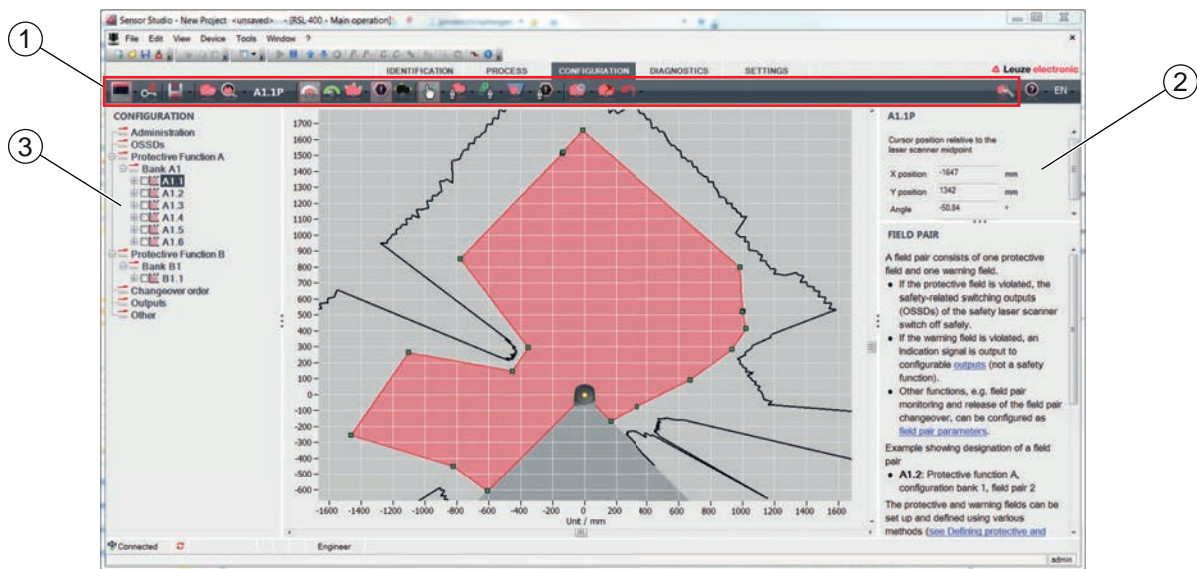

- 1 Toolbar of field editor
- 2 Display of field coordinates
- 3 Structure of safety configuration

Fig. 9.2: Field editor with toolbar for field definition

- ↪ In the **CONFIGURATION** menu, click the field pair the protective and warning fields of which you want to define.
- ↪ Click the  button and define the contours and boundaries of the protective field.

NOTICE	
	<p>Determine protective field size!</p> <p>The protective field size is determined by the calculated safety distances and additional distances that you determined for the application assigned to the configuration bank.</p>

NOTICE	
	<p>With protective field boundaries <200 mm, object detection may be restricted owing to the measurement error.</p> <ul style="list-style-type: none"> ↪ When defining the protective field, take into account the additional distance Z_{sm} to the protective field contour (see chapter 7.2 "Stationary danger zone guarding").

- ↪ Click the  button and define the contours and boundaries of the warning field.

NOTICE	
	<p>By right-clicking the field pair in the CONFIGURATION menu, you can calculate an autocontour for the protective or warning field.</p> <p>You can determine the display options for the field editor in the menu SETTINGS > Field editor display options (see chapter 4.5.6 "SETTINGS").</p>

↵ Configure all other field pairs of the configuration bank following the described procedure.

NOTICE	
	<p>It is also possible to read in an RS4 configuration file as well as to convert the protective fields on the RSL 300.</p> <p>Note here, that the converted field pairs are only contour suggestions. Therefore, check that the fields are appropriate for the requirements of your safety application.</p>

9.5 Configuring expanded shock monitoring

NOTICE	
	<p>The <i>expanded shock monitoring</i> function is available beginning with firmware version 5.8.</p>

Activating expanded shock monitoring



To activate the *expanded shock monitoring* function,

- ↵ select the *Expanded shock monitoring* option in the **SETTINGS** menu.
 - ⇒ The **Expanded shock monitoring** dialog box opens.
- ↵ Activate the *expanded shock monitoring* function.

Acknowledging errors

To acknowledge error F1054, you must be logged in with at least access level "Engineer".

- ↵ Select the *Expanded shock monitoring* option in the **SETTINGS** menu.
 - ⇒ If there is a pending error, the [Acknowledgment] button appears in the **Expanded shock monitoring** dialog box.
- ↵ Click on the [Acknowledgment] button and follow the instructions provided by the software.

 ATTENTION	
	<ul style="list-style-type: none"> ↵ Always make sure that the device is only used within its specifications and under the conditions described in these operating instructions. ↵ Protect the device from mechanical damage (see chapter 7 "Mounting"). ↵ Regularly check the safety sensor for any obvious signs of damage or change and perform a regular test of the detection capability (see chapter 11 "Testing").

9.6 Saving configuration

To save the changed configuration loaded in the software, you can transfer the configuration and settings to the safety sensor or save them in a file on the PC.

Saving safety configuration as PDF file

- ↵ In the **CONFIGURATION** menu, click the [Create PDF file of safety configuration] button.
- ↵ Determine the storage location and the file name for the safety configuration.
- ↵ Click [Save].
- ⇒ The safety configuration is saved as a PDF file.

Saving configuration and settings as file

- ↵ In the **CONFIGURATION** menu or in the **SETTINGS** menu, click the [Save configuration and settings to file] button.
- ↵ Determine the storage location and the name of the configuration file.
- ↵ Click [Save].
- ⇒ The configuration and settings are saved in the file format *.xml.

Saving configuration project as file

- ↵ In the menu bar of the FDT frame menu, click the  button. Alternatively, select the menu command **File > Save**.
- ↵ Determine the storage location and the name of the configuration project file.
- ↵ Click [Save].

9.7 Transferring configuration project to safety sensor

The changes that you have made to the configuration only become effective when the changed configuration project file is transferred to the safety sensor.

Prerequisites:

- The software and safety sensor are connected.
- The changed configuration project has been loaded in the software.
- The individual password for the access level *Engineer* is available.
 - Only users with the access level *Engineer* can transfer configuration data to the safety sensor. To change the access level, see chapter 9.8 "Selecting access level".
 - If no individual password has been defined for the access level *Engineer*, use the preset default password (**safety**).

NOTICE

Alternatively, you can transfer a configuration project saved as a file on the PC directly to the safety sensor.

- ↵ In the menu bar of the FDT frame menu, click the [download arrow] button. Alternatively: In the FDT menu bar, select **Device > Download parameters**.
- ⇒ The software asks for the access level and the password.
- ↵ Select the access level *Engineer* and enter the preset default password (**safety**) or the defined individual password. Confirm with [OK].
- ↵ Before downloading the safety configuration, check whether you are connected to the correct safety sensor. Confirm the displayed safety notice with [Yes].

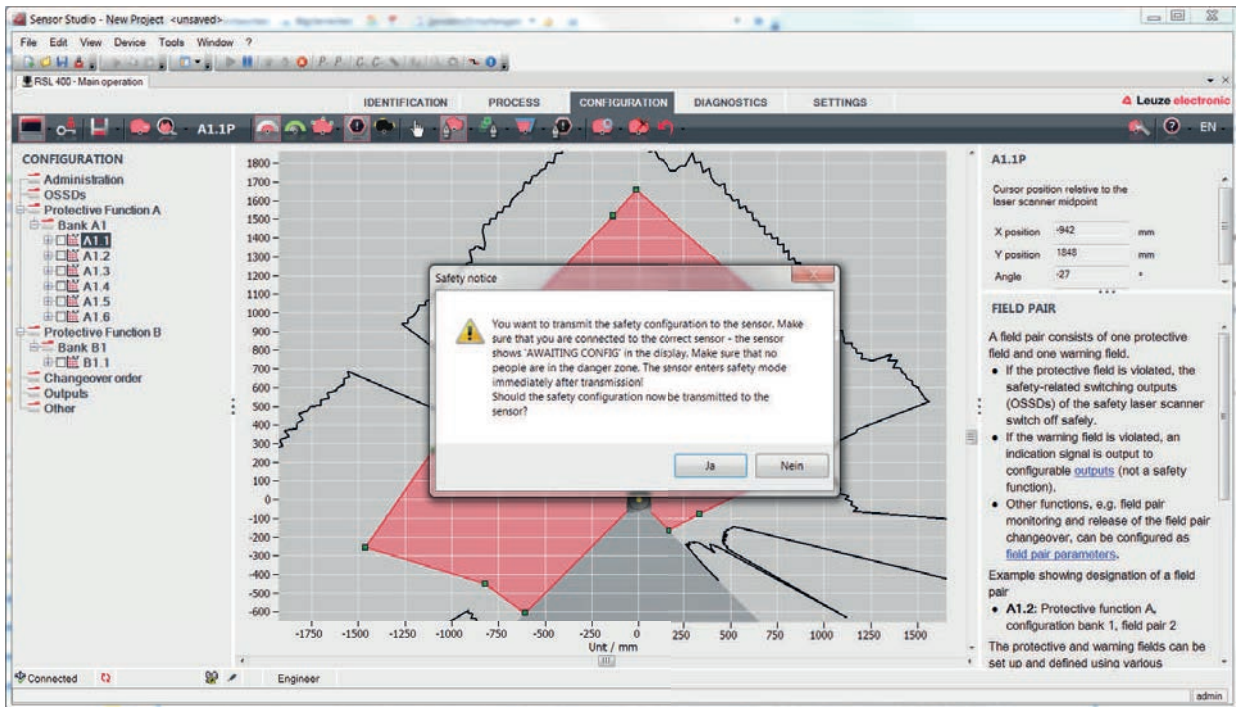



Fig. 9.3: Check before safety configuration is downloaded

The software transfers the data of the configuration project to the safety sensor.

After successful transfer, the safety sensor immediately enters safety mode, i.e. the safety-related switching outputs switch on if all conditions are fulfilled.

- The configuration data is saved in the connection unit of the safety sensor.
- A copy of the safety configuration is saved in the scanner unit of the safety sensor. If, due to a device swap-out, the scanner unit is attached to a brand new, unconfigured connection unit, the safety configuration is transferred from the scanner unit to the connection unit.

NOTICE	
	<p>Observe the safety notices regarding changes to the configuration!</p> <p>Transferring the safety configuration from the scanner unit to the connection unit corresponds to reconfiguration of the system consisting of scanner unit and connection unit.</p> <p>↳ Observe the relevant safety notices regarding changes to the configuration (see chapter 9.1 "Defining safety configuration").</p>

↳ Check the displayed signature.

↳ Confirm successful transfer of the safety configuration to the safety sensor with [OK].

The safety configuration has only been successfully transferred to the safety sensor when the confirmation dialog is displayed during the download.

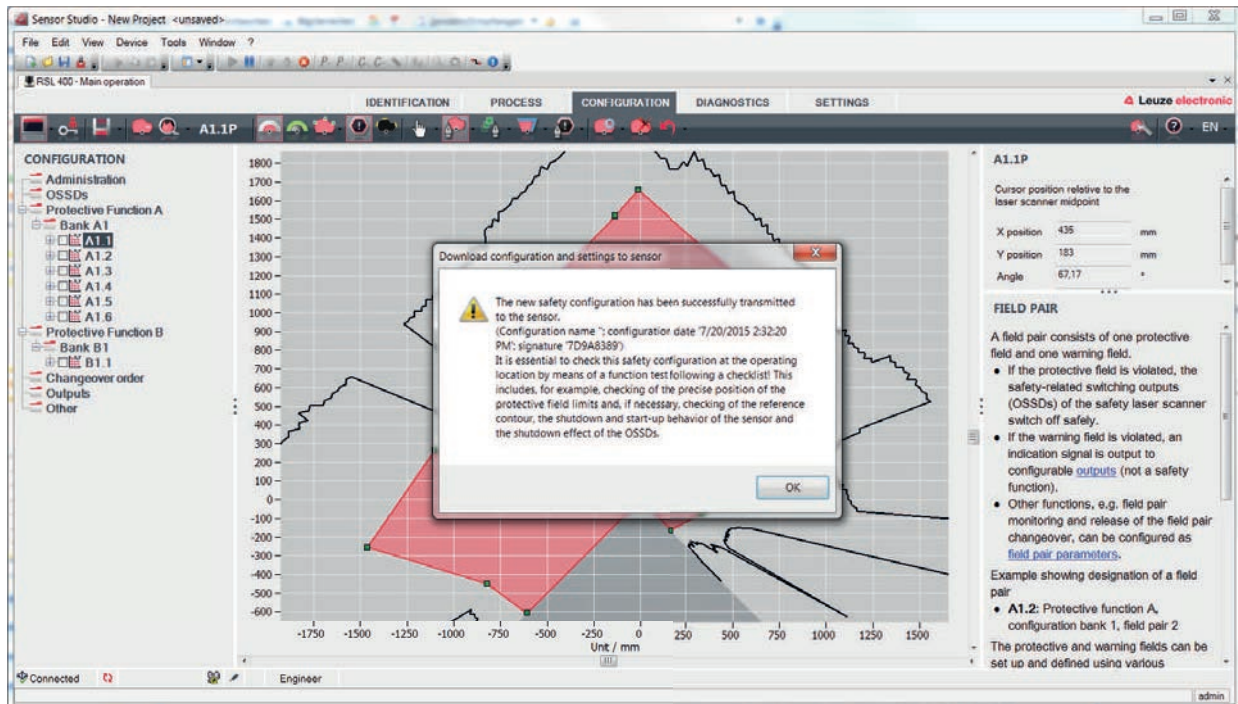



Fig. 9.4: Confirmation: safety configuration downloaded

NOTICE	
	The safety-related switching outputs will already have switched on if all conditions are fulfilled.

⇒ The software has saved the configuration project in the safety sensor.

9.8 Selecting access level

Using the device manager (DTM) you can change the access level of the user, if necessary (see chapter 5.1 "Authorization concept of safety sensor").



- ↪ Click in the DTM menu bar on the Change access level button (.
- ⇒ The **Change access level** dialog box opens.
- ↪ In the **Authorization** list, select the item *Engineer*, *Expert* or *Observer* and enter the default password or the password defined for the individual user (see chapter 4.5.6 "SETTINGS").
 - Default password for *Engineer*: **safety**
 - Default password for *Expert*: **comdiag**
- ↪ Confirm with [OK].

9.9 Reset safety configuration

The device manager (DTM) can be used to reset the safety configuration to the default configuration (one protective function, no restart).

- ↪ In the DTM menu bar, click the [Reset safety configuration] button.
- ⇒ Users with the access level *Engineer* can additionally transfer the changed safety configuration to the safety sensor (see chapter 9.7 "Transferring configuration project to safety sensor").

10 Starting up the device

 WARNING	
	<p>Improper use of the safety sensor may result in serious injury!</p> <ul style="list-style-type: none"> ↪ Make certain that the entire device and the integration of the optoelectronic protective device was inspected by competent and instructed persons. ↪ Make certain that a dangerous process can only be started while the safety sensor is switched on.

Prerequisites:

- Safety sensor mounted (see chapter 7 "Mounting") and connected (see chapter 8 "Electrical connection") correctly
- Machine operators were instructed in proper use
- Dangerous process is switched off, outputs of the safety sensor are disconnected, and the system is protected against being switched back on
- ↪ After start-up, check the function of the safety sensor (see chapter 11.1 "Before the initial start-up and following modifications").

10.1 Switching on

Requirements for the supply voltage (power supply unit):

- Safe mains separation is ensured.
- Current reserve of at least 3 A is available.
- ↪ Switch on the safety sensor.



10.2 Aligning the safety sensor

NOTICE	
	<p>Faulty or incorrect alignment may result in an operating fault!</p> <ul style="list-style-type: none"> ↪ The alignment performed during start-up should only be performed by qualified personnel. ↪ Observe the data sheets and mounting instructions of the individual components.

To simplify alignment during start-up, the safety sensors of the RSL 300 series have an integrated electronic spirit level.

- ↪ Align the safety sensor using the integrated electronic spirit level.

10.3 Unlocking start/restart interlock

 WARNING	
	<p>Premature unlocking of the start/restart interlock may result in serious injury!</p> <p>If the start/restart interlock is unlocked, the system can start up automatically.</p> <ul style="list-style-type: none"> ↪ Before unlocking the start/restart interlock, make certain that no people are in the danger zone.

The responsible person can restore the ON state of the safety sensor following process interruptions (due to triggering of protective function, failure of the voltage supply).

- ↪ Unlock the start/restart interlock using the reset button.
The safety-related switching outputs are only enabled if you hold down the reset button for between 0.12 s and 4 s.

10.4 Shutting down

Temporarily shutting down the machine with the safety sensor

When you shut down the machine with the safety sensor temporarily, you do not have to observe any more steps. The safety sensor saves the configuration and starts again with the switch-on with this configuration.

Shutting down safety sensor and removing from machine

When you shut down the safety sensor and store it away for a later use, you must reset the safety sensor to the factory settings.

Reset the safety sensor to the factory settings using the software:

- ↳ In the device manager (DTM) of the safety sensor, select the *CONFIGURATION* tab.
- ↳ Click the [Reset safety configuration] button.

10.5 Restarting

Restarting the machine with the safety sensor

If you have only shut down the system with the safety sensor temporarily and are restarting the system without any changes, you can restart the safety sensor with the configuration that applied with the shut-down. The configuration remains saved in the safety sensor.

- ↳ Perform a function test (see chapter 11.3 "Periodically by the operator").

Starting up machine with safety sensor after modification or reconfiguration

If you have performed significant changes on the machine or have reconfigured the safety sensor, the safety sensor must be checked as with the initial start-up.

- ↳ Test the safety sensor (see chapter 11.1 "Before the initial start-up and following modifications").

10.6 Starting up replacement scanner unit

The replacement scanner unit and the original scanner unit must be the same with regard to the following points:

- Scanner unit type in accordance with name plate or downward compatible with previous scanner unit with greater range and greater function range
- Mounting on the existing connection unit

Mounting and aligning replacement scanner unit

- ↳ Mount the replacement scanner unit on the connection unit instead of the original scanner unit (see chapter 13.1 "Changing scanner unit").

NOTICE



Realignment of safety sensor not necessary!

Realignment of the safety sensor is not necessary since the replacement scanner unit is mounted on the existing, aligned connection unit.

Transferring configuration to replacement scanner unit

The configuration stored in the connection unit is automatically transferred to the replacement scanner unit.



WARNING



Malfunctioning of safety sensor due to incorrect configuration!

- ↳ The safety sensor configuration stored in the connection unit can only be adopted without changes if the replacement scanner unit and the original scanner unit are downward compatible with respect to range and performance class. The replacement scanner unit will reject an invalid configuration.
- ↳ Change the configuration parameters of the safety sensor using the configuration and diagnostic software according to the performance class of the replacement scanner unit.
- ↳ Change the configuration parameters of the safety sensor using the configuration and diagnostic software according to the operating range of the replacement scanner unit.

Transferring configuration with the PC

If the range and/or performance class of the replacement scanner unit is not compatible with the original scanner unit, you must adapt the configuration of the safety sensor to the replacement scanner unit.

- ↪ Connect the safety sensor's Ethernet communication interface with the PC.
- ↪ Configure the safety sensor according to the range and performance class of the replacement scanner unit (see chapter 9 "Configuring the safety sensor").
- ↪ Transfer the configuration to the safety sensor with the replacement scanner unit.
- ⇒ The alphanumerical display confirms successful transfer of the configuration.
The replacement scanner unit is not compatible with the connection unit if the safety sensor displays a fault.

NOTICE



Extension of boot time!

After installing large configurations, the boot time of the safety sensor can increase significantly.

Checking replacement scanner unit



The check performed on the replacement device depends on whether you automatically adopted the configuration from the connection unit or whether you transferred the changed configuration to the safety sensor.

- ↪ If you adopted the configuration from the connection unit, check the safety sensor using the checklist for the daily test.
- ↪ If you transferred a new configuration to the safety sensor, check the safety sensor according to the routine for initial start-up (see chapter 11.1.1 "Checklist for integrator – to be performed prior to the initial start-up and following modifications").

11 Testing

NOTICE	
	<ul style="list-style-type: none"> ↪ Always exchange entire safety sensors. ↪ For the tests, observe, if necessary, nationally applicable regulations. ↪ Document all tests in a comprehensible manner and include the configuration of the safety sensor along with the data for the safety- and minimum distances in the documentation.

11.1 Before the initial start-up and following modifications

 WARNING	
	<p>Unpredictable machine behavior during initial start-up may result in serious injury!</p> <ul style="list-style-type: none"> ↪ Make certain that there are no people in the danger zone.

↪ Before they begin work, train the operators on their respective tasks. The training is the responsibility of the operating company.

↪ Attach notes regarding daily testing in the respective national language of the operator on the machine in a highly visible location, e.g. by printing out the corresponding chapter (see chapter 11.3 "Periodically by the operator").

↪ Test the electrical function and installation according to this document.

Acc. to EN IEC 62046 and national regulations (e.g. EU directive 2009/104/EC), tests are to be performed by competent persons in the following situations:

- Prior to initial commissioning
- Following modifications to the machine
- After longer machine downtime
- Following retrofitting or new configuration of the machine

↪ As preparation, check the most important criteria for the safety sensor according to the following checklist (see chapter 11.1.1 "Checklist for integrator – to be performed prior to the initial start-up and following modifications"). Completing the checklist does not replace testing by a competent person!

Not until proper function of the safety sensor is ascertained may it be integrated in the control circuit of the system.

11.1.1 Checklist for integrator – to be performed prior to the initial start-up and following modifications

NOTICE	
	<p>Completing the checklist does not replace testing by a competent person!</p> <ul style="list-style-type: none"> ↪ If you answer one of the items on the check list with <i>no</i>, the machine must no longer be operated (see table below). ↪ EN IEC 62046 contains additional recommendations on testing protective devices.

Tab. 11.1: Checklist for integrator – to be performed prior to the initial start-up and following modifications

Check:	Yes	No	n. a. not applicable
Is the safety sensor operated acc. to the specific environmental conditions that are to be maintained (see chapter 15 "Technical data")?			
Is the safety sensor correctly aligned and are all fastening screws and connectors secure?			
Are safety sensor, connection cables, connectors, protection caps and command devices undamaged and without any sign of manipulation?			
Does the safety sensor satisfy the required safety level (PL, SIL, category)?			
Are the safety-related switching outputs (OSSDs) integrated in the downstream machine control acc. to the required safety category?			
Are switching elements that are controlled by the safety sensor monitored according to the required safety level (PL, SIL, category) (e.g., contactors through EDM)?			
Are all points of operation near the safety sensor accessible only through the protective field of the safety sensor?			
Are the necessary additional protective devices in the immediate surroundings (e.g., safety guard) properly mounted and secured against tampering?			
If it is possible to be present undetected between the safety sensor and point of operation: is an assigned start/restart interlock functional?			
Is the command device for unlocking the start/restart interlock mounted in such a way that it cannot be reached from within the danger zone and so that the complete danger zone can be seen from the installation location?			
Has the maximum stopping time of the machine been measured and documented?			
Is the required safety distance maintained?			
Does interruption with a test object intended for this purpose cause the dangerous movement(s) to stop?			
Is the safety sensor effective during the entire dangerous movement(s)?			
Is the safety sensor effective in all relevant operating modes of the machine?			
Is start-up of dangerous movements reliably prevented if the protective field is interrupted with a test object intended for this purpose?			
Was the sensor detection capacity successfully tested (see chapter 11.3.1 "Checklist – periodically by the operator")?			
Were distances to reflective surfaces taken into account during configuration and no reflection bypasses subsequently detected?			
Are notices for regular testing of the safety sensor legible to the operator and are they located in a highly visible location?			
Are changes to the safety function (e.g. field pair changeover) not easy to achieve through tampering?			
Are settings that could result in an unsafe state possible only by means of key, password or tool?			
Are there incentives that pose stimulus for tampering?			
Were the operators instructed prior to starting work?			

11.2 To be performed periodically by competent persons

The reliable interaction of safety sensor and machine must be periodically tested by competent persons in order to detect changes to the machine or impermissible tampering with the safety sensor.



Acc. to EN IEC 62046 and national regulations (e.g., EU directive 2009/104/EC), tests of elements which are subject to wear must be performed by competent persons at regular intervals. Testing intervals may be regulated by nationally applicable regulations (recommendation acc. to EN IEC 62046: 6 months).

- ↪ Have all tests performed by competent persons.
- ↪ Observe the nationally applicable regulations and the time periods specified therein.
- ↪ As preparation, observe the checklist (see chapter 11.1 "Before the initial start-up and following modifications").

11.3 Periodically by the operator

The function of the safety sensor must be checked regularly (e.g., daily, on shift change, monthly or in an even longer cycle) according to the following checklist. The frequency of the checks is determined by means of the risk analysis performed by the operating company.

Due to complex machines and processes, it may be necessary under certain circumstances to check some points at longer time intervals. Observe the classification in "Test at least" and "Test when possible".

 WARNING	
	<p>Unpredictable machine behavior during the test may result in serious injury!</p> <ul style="list-style-type: none"> ↪ Make certain that there are no people in the danger zone. ↪ Before they begin work, train the operators on their respective tasks and provide suitable test objects and an appropriate test instruction.

11.3.1 Checklist – periodically by the operator

NOTICE	
	<p>↪ If you answer one of the items on the check list with <i>no</i>, the machine must no longer be operated (see chapter 11.1.1 "Checklist for integrator – to be performed prior to the initial start-up and following modifications").</p>

Tab. 11.2: Checklist – regular function test by trained operators/persons

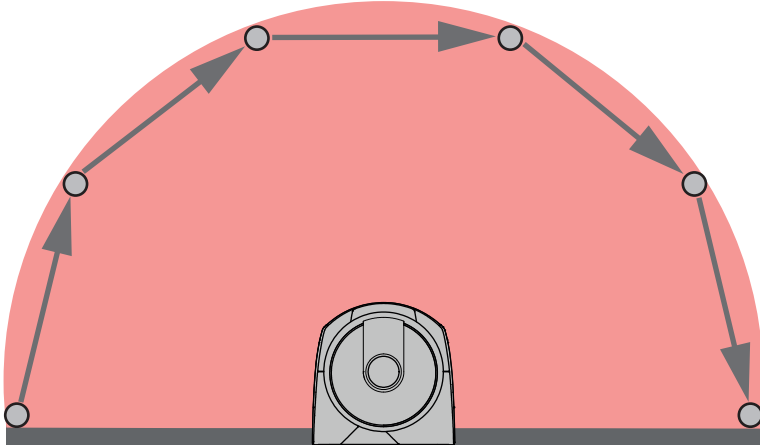
Test at least:	Yes	No
Are safety sensor and connectors securely mounted and free of obvious signs of damage, changes or tampering?		
Were obvious changes made to access or entry possibilities?		
<p>Test the effectiveness of the safety sensor:</p> <ol style="list-style-type: none"> 1. The LED 1 on the safety sensor must illuminate green (see chapter 3.3 "Display elements"). 2. Interrupt the protective field using a suitable opaque test object (Leuze RSL400 test rod or similar test object with 1.8 % diffuse reflectance at wavelength = 905 nm). 		
		
<p>Checking the protective field function with test object. Use a test object with the set resolution. The test object should have a matt surface structure. Does the LED 1 on the safety sensor illuminate constantly red while the protective field is interrupted?</p>		

Tab. 11.3: Checklist – regular function test by trained operators/persons

When possible, test during running operation:	Yes	No
Protective device with approach function: during machine operation, the protective field is interrupted with the test object – are the obviously dangerous machine parts stopped without noticeable delay?		
Protective device with presence detection: the protective field is interrupted with the test object – does this prevent operation of the obviously dangerous machine parts?		

12 Diagnosis and troubleshooting

12.1 What to do in case of failure?

After switching the safety sensor on, the display elements assist in checking the correct functionality and in faultfinding (see chapter 3.3 "Display elements").

In case of failure, you can determine the fault from the LED displays and read a message from the display. With the error message you can determine the cause of the error and initiate measures to rectify it.

NOTICE	
	<p>If the safety sensor responds with an error display, you will often be able to eliminate the cause yourself!</p> <ul style="list-style-type: none"> ↳ Switch off the machine and leave it switched off. ↳ Analyze the cause of the fault using the diagnostics displays and rectify the fault. ↳ If you are unable to rectify the fault, contact the Leuze branch responsible for you or call the Leuze customer service (see chapter 14 "Service and support").

12.2 Diagnostics displays

The diagnostics displays consist of one letter plus four numbers, divided into classes consisting of letters and the first number.

Diagnostics classes:

- I (Information)
 - No OSSD switch-off
 - Unhindered operation possible
- U (Usage)
 - Application error
- E (External)
 - External fault
- F (Failure)
 - internal device error
 - OSSD switch-off
 - Self test unsuccessful
 - Hardware error
- P (Parameter)
 - Inconsistency in configuration

Tab. 12.1: Diagnostics displays in order of ascending ID number

Diagnostic ID	Diagnostic message	Measure
U0370	Input level at the electrical inputs is unclear.	Check the wiring of the safety sensor.
P0409	Safety configuration is not compatible: unknown bank switchover.	Swap out the safety sensor or change the configuration. The type of safety sensor must be the same as the type stored in the connection unit or in the <i>Sensor Studio</i> software.
P0410	Safety configuration is not compatible: unknown output signals.	Swap out the safety sensor or change the configuration. The type of safety sensor must be the same as the type stored in the connection unit or in the <i>Sensor Studio</i> software.
P0413	Safety configuration is not compatible: unknown inputs SE1 and SE2.	Swap out the safety sensor or change the configuration. The type of safety sensor must be the same as the type stored in the connection unit or in the <i>Sensor Studio</i> software.

Diagnostic ID	Diagnostic message	Measure
P0414	Safety configuration is not compatible: unknown EDM inputs.	Swap out the safety sensor or change the configuration. The type of safety sensor must be the same as the type stored in the connection unit or in the <i>Sensor Studio</i> software.
P0415	Safety configuration is not compatible: unknown field pair monitoring mode.	Swap out the safety sensor or change the configuration. The type of safety sensor must be the same as the type stored in the connection unit or in the <i>Sensor Studio</i> software.
P0416	Safety configuration is not compatible: unknown field pair monitoring parameters.	Swap out the safety sensor or change the configuration. The type of safety sensor must be the same as the type stored in the connection unit or in the <i>Sensor Studio</i> software.
P0417	Safety configuration is not compatible: unknown field pair monitoring mode.	Swap out the safety sensor or change the configuration. The type of safety sensor must be the same as the type stored in the connection unit or in the <i>Sensor Studio</i> software.
P0419	Safety configuration is not compatible: unknown monitoring parameter for the changeover order.	Swap out the safety sensor or change the configuration. The type of safety sensor must be the same as the type stored in the connection unit or in the <i>Sensor Studio</i> software.
P0420	Safety configuration is not compatible: unknown monitoring mode of the field pair changeover.	Swap out the safety sensor or change the configuration. The type of safety sensor must be the same as the type stored in the connection unit or in the <i>Sensor Studio</i> software.
P0421	Safety configuration is not compatible: unknown parameter for field pair changeover monitoring.	Swap out the safety sensor or change the configuration. The type of safety sensor must be the same as the type stored in the connection unit or in the <i>Sensor Studio</i> software.
P0422	Safety configuration is not compatible: unknown field pair selection mode.	Swap out the safety sensor or change the configuration. The type of safety sensor must be the same as the type stored in the connection unit or in the <i>Sensor Studio</i> software.
P0423	Safety configuration is not compatible: unknown field pair selection parameter.	Swap out the safety sensor or change the configuration. The type of safety sensor must be the same as the type stored in the connection unit or in the <i>Sensor Studio</i> software.
P0424	Safety configuration is not compatible: unknown parameter for manipulation monitoring.	Swap out the safety sensor or change the configuration. The type of safety sensor must be the same as the type stored in the connection unit or in the <i>Sensor Studio</i> software.
P0425	Safety configuration is not compatible: unknown configuration of the output signals.	Swap out the safety sensor or change the configuration. The type of safety sensor must be the same as the type stored in the connection unit or in the <i>Sensor Studio</i> software.
P0426	Safety configuration is not compatible: unknown resolution.	Swap out the safety sensor or change the configuration. The type of safety sensor must be the same as the type stored in the connection unit or in the <i>Sensor Studio</i> software.
P0427	Safety configuration is not compatible: unknown parameter.	Swap out the safety sensor or change the configuration. The type of safety sensor must be the same as the type stored in the connection unit or in the <i>Sensor Studio</i> software.

Diagnostic ID	Diagnostic message	Measure
P0429	Safety configuration is not compatible: unknown start/restart mode.	Swap out the safety sensor or change the configuration. The type of safety sensor must be the same as the type stored in the connection unit or in the <i>Sensor Studio</i> software.
P0430	Safety configuration is not compatible: unknown start mode.	Swap out the safety sensor or change the configuration. The type of safety sensor must be the same as the type stored in the connection unit or in the <i>Sensor Studio</i> software.
P0431	Safety configuration is not compatible: unknown restart mode.	Swap out the safety sensor or change the configuration. The type of safety sensor must be the same as the type stored in the connection unit or in the <i>Sensor Studio</i> software.
P0432	Safety configuration is not compatible: unknown OSSD stop mode.	Swap out the safety sensor or change the configuration. The type of safety sensor must be the same as the type stored in the connection unit or in the <i>Sensor Studio</i> software.
U0573	EDM fault at system start.	Check the wiring of the downstream relays and that they are functioning correctly.
U0574	Switching fault, EDM at OSSD A: external relay does not switch off.	Check the wiring of the downstream relays and that they are functioning correctly.
U0575	Switching fault, EDM at OSSD A: external relay does not switch on.	Check the wiring of the downstream relays and that they are functioning correctly.
U0576	Switching fault, EDM at OSSD B: external relay does not switch off.	Check the wiring of the downstream relays and that they are functioning correctly.
U0577	Switching fault, EDM at OSSD B: external relay does not switch on.	Check the wiring of the downstream relays and that they are functioning correctly.
U0580	Switching fault at inputs SE1 and SE2; external safety device does not switch in accordance with the specifications.	Check the wiring of the external safety device and that the parameter settings in the configuration are correct.
U0582	Field pair changeover is not performed in accordance with the specifications configured in the safety sensor: overlap time too long.	Check the changeover times of function inputs F1 to F10 or the parameter settings in the configuration.
U0583	Field pair changeover is not performed in accordance with the specifications configured in the safety sensor: no signal for field pair activation.	Check the wiring and the changeover times of function inputs F1 to F10.
U0584	Field pair changeover is not performed in accordance with the specifications configured in the safety sensor: changeover time exceeded.	Check the changeover times of function inputs F1 to F10 or the parameter settings in the configuration.
U0585	Field pair changeover is not performed in accordance with the specifications configured in the safety sensor: changeover order not observed.	Check the wiring of function inputs F1 to F10 and that the parameter settings in the configuration are correct.
U0792	Field pair changeover without release.	Check the release signal for field pair changeover or change the safety configuration.
U0793	Field pair changeover without request.	Check the request signal for field pair changeover or change the safety configuration.
U0849	Field pair changeover not permitted.	Check the wiring of the field pair inputs.

Diagnostic ID	Diagnostic message	Measure
E0588	Optics cover is soiled.	Clean the optics cover.
I0604	Optics cover is soiled.	Clean the optics cover as soon as possible. Sensor is still in safety mode.
P0653	Safety configuration is not compatible: protective/warning field radius too large.	Swap out the safety sensor or change the configuration. The type of safety sensor must be the same as the type stored in the connection unit or in the <i>Sensor Studio</i> software.
P0654	Field pair changeover is not performed in accordance with the specifications configured in the safety sensor: field pair not defined.	Check the wiring of function inputs F1 to F10 and that the parameter settings in the configuration are correct.
I0660	Field pair changeover is not performed in accordance with the specifications configured in the safety sensor: no field pair activated at system start.	Check the wiring of function inputs F1 to F10 and that the parameter settings in the configuration are correct.
U0661	Safety-related switching outputs (OSSDs) cannot be switched: short circuit with 0 V, +24 V DC or between OSSDs.	Check the wiring of the OSSDs.
I0719	Timeout of signals RES1 or RES2 (acknowledgment button, start/restart).	Check the wiring of inputs RES1 and RES2. The time specifications for start/restart must be observed.
P0747	Safety configuration is not compatible: protective/warning field radius too small.	Change the dimensions and contour of the protective field in the configuration. The minimum range of the protective field must be observed.
I0825	Simulation mode has been activated.	The safety-related switching outputs (OSSDs) have been switched off.
I0826	Simulation mode has been deactivated.	Safety sensor is again in safety mode. CAUTION! Be aware of potential hazards which can occur when the machine is started up!
I0859	Configuration was reset.	+24 V detected at RES input after switch-on. The communication parameters were reset to default values.
I1004	Field violation due to glare. (With switch-off of the OSSDs)	Mount the safety sensor so that the light source does not hit the outlet disc directly.
I1005	Dazzled RSL. (Without switch-off of the OSSDs)	Mount the safety sensor so that the light source does not hit the outlet disc directly.
F....	The monitoring functions have detected an internal error.	Create the service file (see chapter 4.5.5 "DIAGNOSIS") and contact the Leuze customer service (see chapter 14 "Service and support").
F1054	Expanded shock monitoring activated, shock detected by the safety sensor.	Open the Settings > Expanded shock monitoring menu in the Sensor Studio. Press [Acknowledgment] and follow the described instructions. Acknowledgment is only possible with the "Engineer" access level.

13 Care, maintenance and disposal

13.1 Changing scanner unit

If the safety sensor check or an error message indicates a defective scanner unit, change the scanner unit. Only a trained and competent person is permitted to change the scanner unit.

The scanner unit is changed as follows:

- Detach the scanner unit from the connection unit.
- Attach the replacement scanner unit to the connection unit.

NOTICE



Safety sensor malfunction caused by dirt!

- ↪ Perform all work in an environment which is as dust-free and dirt-free as possible.
- ↪ Do not touch any of the parts inside the device.



WARNING



Malfunctioning of safety sensor due to incompatibility of connection unit and scanner unit! Malfunctioning of safety sensor due to incorrect configuration!

- ↪ Wherever possible, replace the scanner unit with a scanner unit with the same range and performance class (e.g. RSL 420-M with RSL 420-M). The safety sensor configuration stored in the connection unit is only adopted without changes if the new scanner unit supports all configured functions.
- ↪ Change the configuration parameters of the safety sensor using the configuration and diagnostic software according to the performance class of the scanner unit or of the connection unit.
If a scanner unit is attached to a connection unit with a lower performance class (e.g. scanner unit RSL 430 to connection unit CU416), the integrated cable management of the connection unit means that only the functions of the lower performance class (of the connection unit) are available.
If a scanner unit is attached to a connection unit with a higher performance class (e.g. RSL 420 scanner unit to CU429 connection unit), the performance of the scanner unit restricts the functions to those of the lower performance class (of the scanner unit).
- ↪ Change the configuration parameters of the safety sensor using the configuration and diagnostic software according to the operating range of the replaced scanner unit. If the scanner unit is replaced with a scanner unit with a different range (e.g. RSL 420-L with RSL 420-M), you must check and, if necessary, adapt the configuration of the safety sensor.

NOTICE



The RSL 311 can only be operated in combination with connection unit CU308-M12.

- ↪ Undo the quick-release fasteners on both sides of the scanner unit.
- ↪ Pull the scanner unit off the connection unit.
- ↪ Place the new scanner unit on the connection unit.
- ↪ Connect and lock the new scanner unit using the quick-release fasteners on both sides.
- ↪ Check the configuration of the safety sensor (see chapter 9 "Configuring the safety sensor").

NOTICE



If a preconfigured scanner unit is attached to a brand new, unconfigured connection unit, the safety configuration stored in the scanner unit is transferred to the connection unit and you can use the safety sensor without reconfiguration after a restart.

- ↪ Check the safety sensor according to the routine for initial start-up (see chapter 11.1.1 "Checklist for integrator – to be performed prior to the initial start-up and following modifications").

13.2 Cleaning the optics cover

Clean the optics cover as required by the application-related load rating.

Use the cleaning set consisting of special cleaning agent and cleaning cloths for cleaning (see chapter 17 "Order guide and accessories").

The procedure for cleaning depends on the kind of contamination:

Soiling	Cleaning
Particles, loose, scouring	Vacuum without touching or blow away softly, oil-free Wipe free in one swipe with cleaning cloth
Particles, loose, non-scouring	Vacuum without touching or blow away softly, oil-free or Wipe free in one swipe with cleaning cloth
Particles, sticking	Wet with cloth soaked in cleaning agent Wipe free in one swipe with cleaning cloth
Particles, statically charged	Vacuum without touching Wipe free in one swipe with cleaning cloth soaked with cleaning agent
Particles/drops, smearing	Wet with cloth soaked in cleaning agent Wipe free in one swipe with cleaning cloth
Water drops	Wipe free in one swipe with cleaning cloth
Oil drops	Wet with cloth soaked in cleaning agent Wipe free in one swipe with cleaning cloth
Fingerprints	Wet with cloth soaked in cleaning agent Wipe free in one swipe with cleaning cloth
Scratches	Change optics cover

NOTICE



The wrong cleaning agents or cloths will damage the optics cover!

↪ Do not use any scouring cleaning agents or scratching cloths.

NOTICE





If cleaning takes longer than four seconds, e.g. with fingerprints, the safety sensor displays a fault of optics cover monitoring. After cleaning is complete, the safety sensor resets itself automatically.

- ↪ Clean the optics cover over the entire 360° range.
- ↪ Soak cloth with cleaning agent.
- ↪ Wipe optics cover free in one swipe.
- ↪ Clean not only the optics cover, but also the reflector ring under the cap.



1 Reflector ring

Fig. 13.1: Reflector ring

NOTICE	
	<p>Internal monitoring of optics cover!</p> <ul style="list-style-type: none"> ↪ The monitored area is dependent on the configuration and can be smaller than the entire scanning range of 270°. ↪ On account of device safety, the internal monitoring of the optics cover monitors a range that is larger than specified by the configured protective field.
WARNING	
	<p>Improper calibration of the optics cover may result in serious accidents!</p> <p>The optics cover may be calibrated only if it is as new, clean and scratch-free. Calibration of a not as new, scratched or soiled window can impair the protective function of the safety sensor.</p>

13.3 Servicing

The device does not normally require any maintenance by the operator.

Repairs to the device must only be performed by the manufacturer.

- ↪ For repairs, contact your responsible Leuze subsidiary or Leuze customer service (see chapter 14 "Service and support").

13.4 Disposing

- ↪ For disposal observe the applicable national regulations regarding electronic components.

14 Service and support

Service hotline

You can find the contact information for the hotline in your country on our website www.leuze.com under **Contact & Support**.

Repair service and returns

Defective devices are repaired in our service centers competently and quickly. We offer you an extensive service packet to keep any system downtimes to a minimum. Our service center requires the following information:

- Your customer number
- Product description or part description
- Serial number and batch number
- Reason for requesting support together with a description

Please register the merchandise concerned. Simply register return of the merchandise on our website www.leuze.com under **Contact & Support > Repair Service & Returns**.

To ensure quick and easy processing of your request, we will send you a returns order with the returns address in digital form.

15 Technical data

15.1 General specifications

Tab. 15.1: Safety-relevant technical data

Type in accordance with EN IEC 61496	Type 3
SIL in accordance with IEC/EN 61508	SIL 2
Maximum SIL in accordance with EN IEC 62061	SIL 2
Performance Level (PL) in accordance with EN ISO 13849-1:2015	PL d
Category in accordance with EN ISO 13849-1:2015	Cat. 3
Average probability of a failure to danger per hour (PFH _d)	9x10 ⁻⁸ 1/h
Mission time (T _M)	20 years (ISO 13849-1) Repairs or the exchange of wear parts do not extend the mission time.

Tab. 15.2: Optics

Laser protection class in accordance with IEC/EN 60825-1	Class 1
Wavelength	905 nm (infrared)
Impulse duration	2.5 ns
Maximum output power (peak)	35 W
Pulse frequency of laser transmitter	90 kHz
Scanning rate	25 scans/s, equal to 40 ms/scan
Scanning angle	Max. 270°
Angular resolution	0.2 °
Tolerance field of reference contour	+200 mm

Tab. 15.3: Protective field data

Safety sensor	RSL 311
Number of field pairs	1
Reference contour selectable	x
Minimum adjustable range	50 mm
Detection range of the test object from the housing edge	The detection capability is limited in the 0 mm to 50 mm range to increase availability.
Diffuse reflectance PF minimum	1.8 %

Tab. 15.4: Protective field range

Device range	S
Resolution [mm]	Protective field range [m]
70	3.00
50	3.00

Tab. 15.5: Warning field data

Safety sensor	RSL 311
Number of field pairs	1
Warning field range	0 – 15 m
Object size	150 mm x 150 mm
Diffuse reflectance WF minimum	10 %

Tab. 15.6: Measurement field data

Detection range	0 ... 25 m
Diffuse reflection	90 %
Radial resolution	1 mm
Lateral resolution	0.2 °

Tab. 15.7: Electrical supply

RSL 311 voltage supply	24 V DC (+20% / -30%)
Power supply unit/battery	Supply acc. to EN IEC 61558 with safe mains separation and equalization for power outages of up to 20 ms acc. to EN IEC 61496-1
Current consumption	Approx. 700 mA (use power supply unit with 3 A)
Power consumption	17 W with 24 V plus output capability
Switch-on current	Max. 2 A
Overvoltage protection	overvoltage protection with protected limit stop
Protective conductor	Connection required
Device connection	Connection cable, M12-8 connector
Connection socket for Ethernet/communication	M12-4 connector, D-coded

Tab. 15.8: Inputs

Reset	+24 V, dynamically monitored (0.12 s to 4 s)
Signal definition:	
High/logical 1	16 - 30 V
Low/logical 0	< 3 V

Tab. 15.9: Safety-related switching outputs

OSSD transistor safety-related switching outputs	2 safe PNP semiconductor outputs Short-circuit proof, cross circuit monitored		
Class (source) acc. to CB24I Edition 2.0.1	C2		
	Minimum	Typical	Maximum
Response time	80 ms (2 scans)		1000 ms (25 scans)
Switching voltage high active	$U_B - 3.2 V$		
Switching voltage low			2.0 V
Switching current			300 mA
Cut-off frequency f_g			1 kHz
Load capacity C_{load}			100 nF
Cable length between safety sensor and load	see chapter 8.3 "Connection unit CU308-M12"		
Cable resistance			15 Ω
Test pulse width	60 μs		110 μs
Test pulse distance	35 ms	40 ms	40 ms

NOTICE



The safety-related transistor outputs perform the spark extinction. With transistor outputs, it is therefore neither necessary nor permitted to use the spark extinction circuits recommended by contactor or valve manufacturers (RC elements, varistors or recovery diodes), since these considerably extend the decay times of inductive switching elements.

Tab. 15.10: Inputs and outputs

Properties	Max. output current I_a	Min. input current I_e	Typical connection components
EX/A = changeover-capable (EA1)	20 mA (-20 mA)	10 mA (-10 mA)	Auxiliary contact of power contactor (EDM)
AX=output Current-limited, short-circuit proof (A1, MELD)	100 mA (-20 mA)	---	Lamp (PNP only) Control input (PNP/NPN)
Signal definition:			
High/logical 1	16 - 30 V		
Low/logical 0	< 3 V		

Tab. 15.11: Software

Configuration and diagnostic software	Sensor Studio for Windows 7 or higher
---------------------------------------	---------------------------------------

Tab. 15.12: General system data

Degree of protection	IP 65 in accordance with IEC/EN 60529
Protection class	III in accordance with IEC/EN 61140
Ambient temperature, operation	0 ... +50 °C
Ambient temperature, storage	-20 ... +60 °C
Humidity	DIN 40040, table 10, code letter E (reasonably dry)
Height above standard elevation zero (operation)	≤ 2000 m
Interference rejection	In acc. with EN IEC 61496-1 (type 4)
Vibration stress over 3 axes	In acc. with IEC/EN 60068 Part 2 – 6, 10 – 55 Hz, max 5 G, additionally acc. to IEC TR 60721 Part 4 – 5, class 5M1, 5 – 200 Hz, max 5 G
Continuous shocks over 3 axes (6 directions)	In acc. with IEC/EN 60068 Part 2 – 29, 100 m/s ² , 16 ms, additionally acc. to IEC TR 60721 Parts 4 – 5, class 5M1, 50 m/s ² , 11 ms
Disposal	Proper disposal required
Housing	Diecast zinc, plastic
Standard version dimensions (ensure free space for connector with fixing and connection cable)	140 x 149 x 140 (W x H x D) in mm
Weight of standard version incl. connection unit	Approx. 3 kg
Distance, scan level center to bottom housing edge	104 mm

Tab. 15.13: Patents

US patents	US 7,656,917 B US 7,696,468 B US 8,520,221 B US 2016/0086469 A
------------	---

15.2 Dimensions

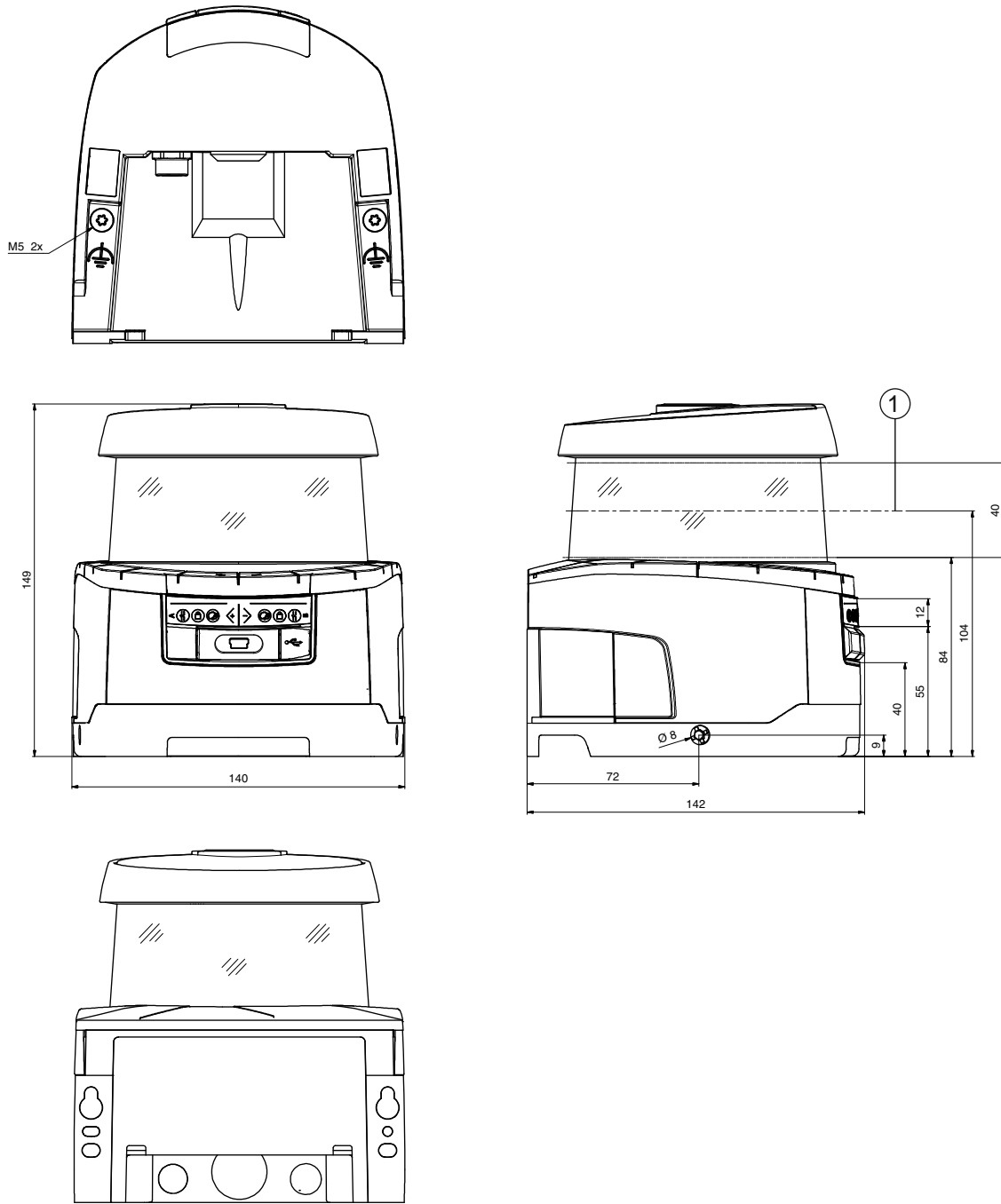

all dimensions in mm

1 Scan level

Fig. 15.1: Dimensions safety laser scanner with connection unit

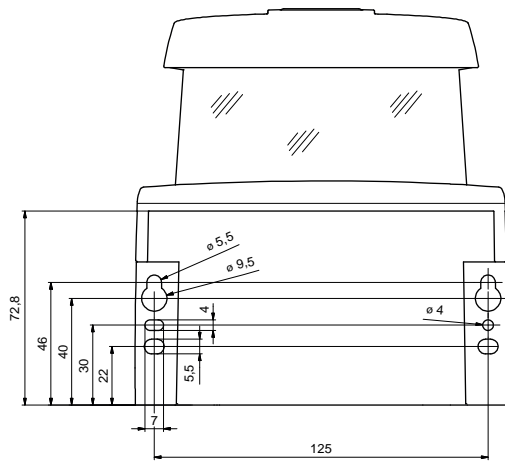

all dimensions in mm

Fig. 15.2: Mounting dimensions safety laser scanner with connection unit

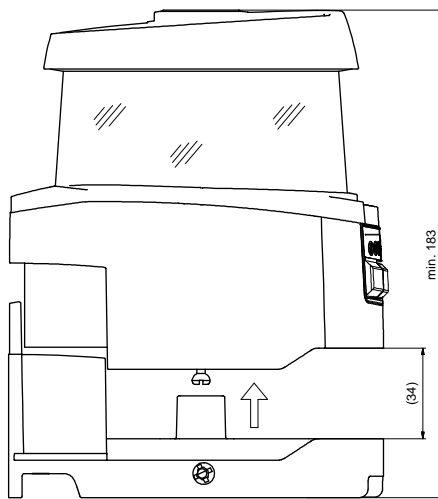

all dimensions in mm

Fig. 15.3: Minimum space requirements for installation and replacement of scanner unit

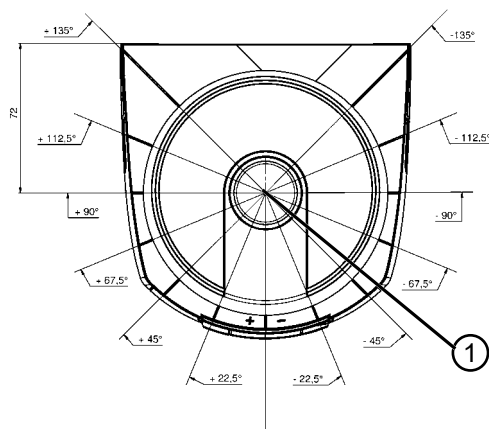

all dimensions in mm

1 Reference point for distance measurement and protective field radius

Fig. 15.4: Dimensions of scanning range

15.3 Dimensioned drawings: Accessories

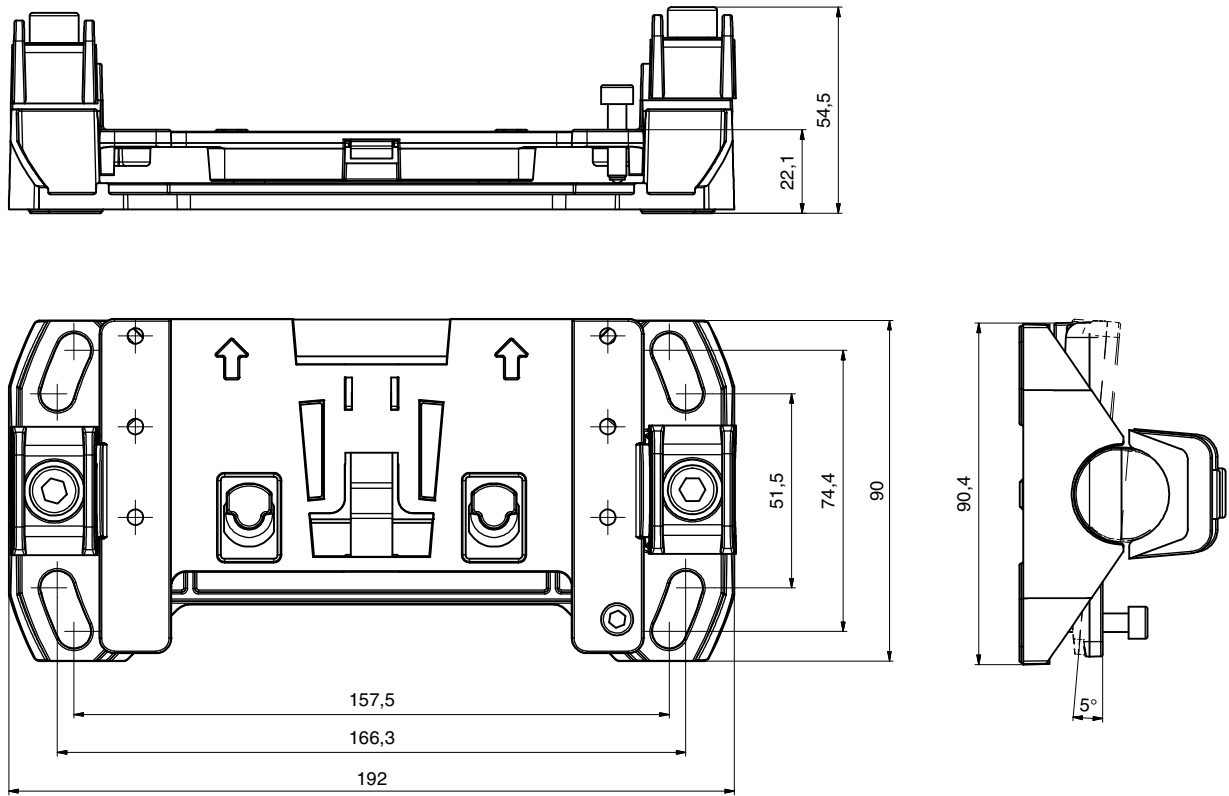

all dimensions in mm

Fig. 15.5: BTU800M mounting system

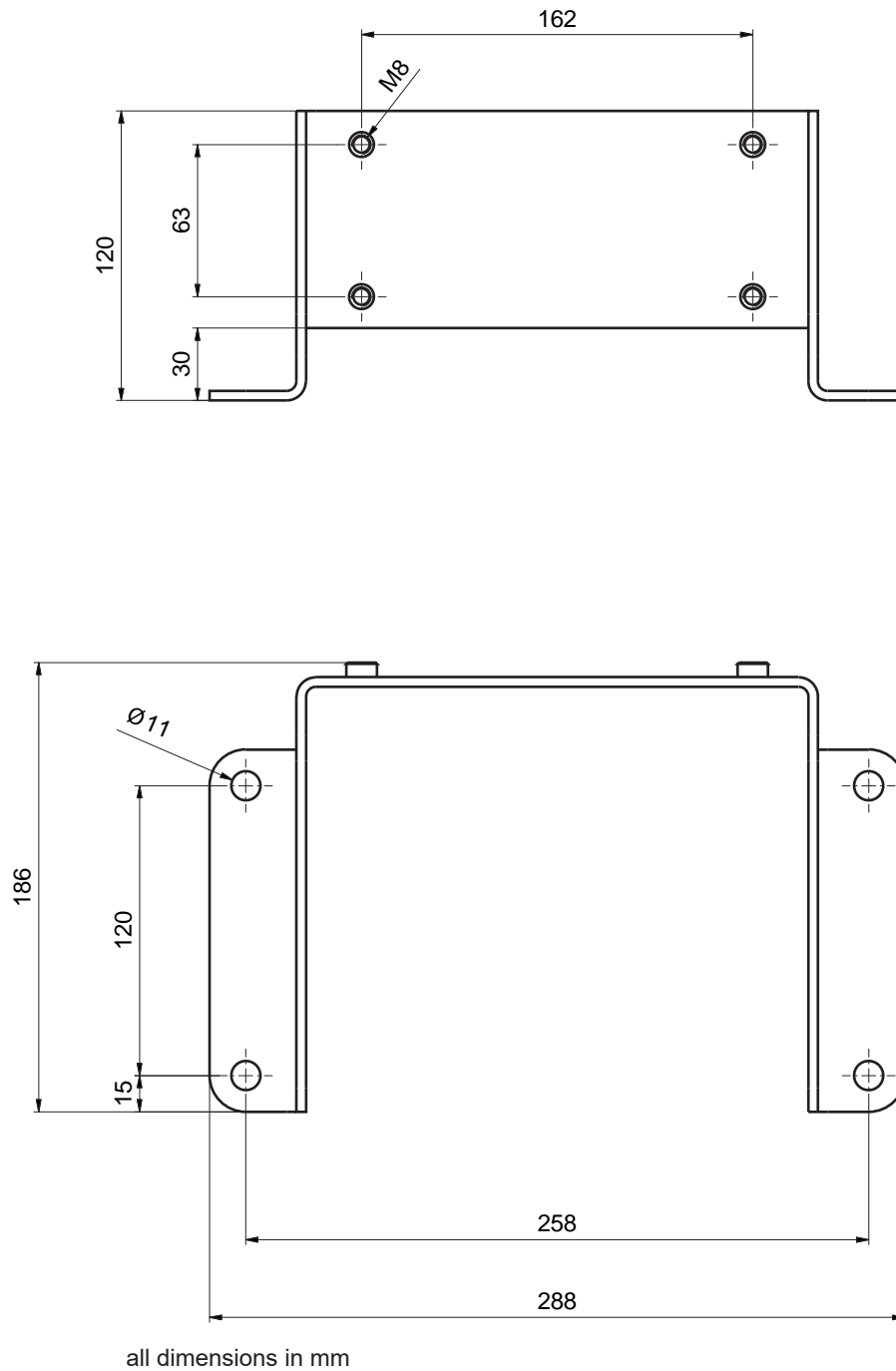

all dimensions in mm

Fig. 15.6: BTF815M mounting bracket

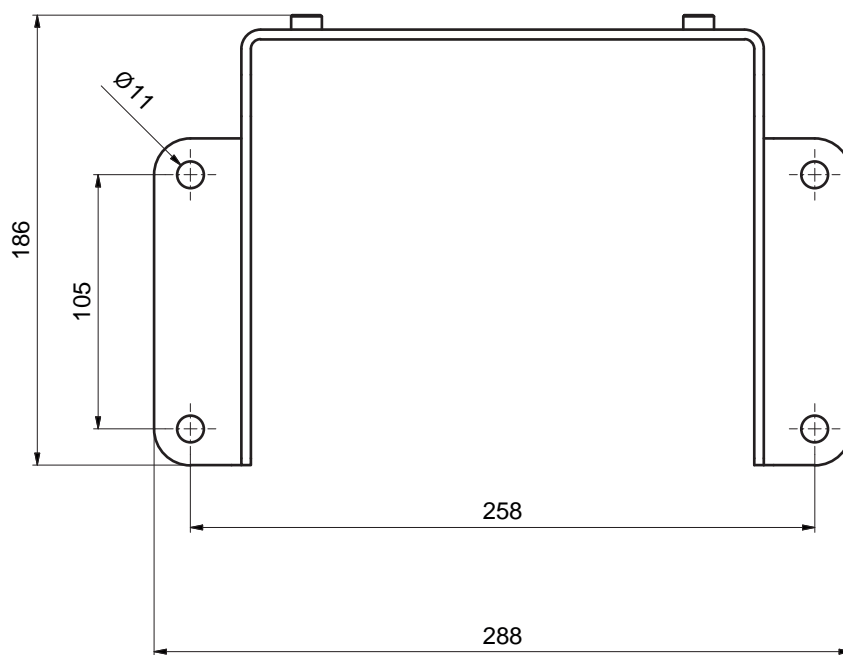
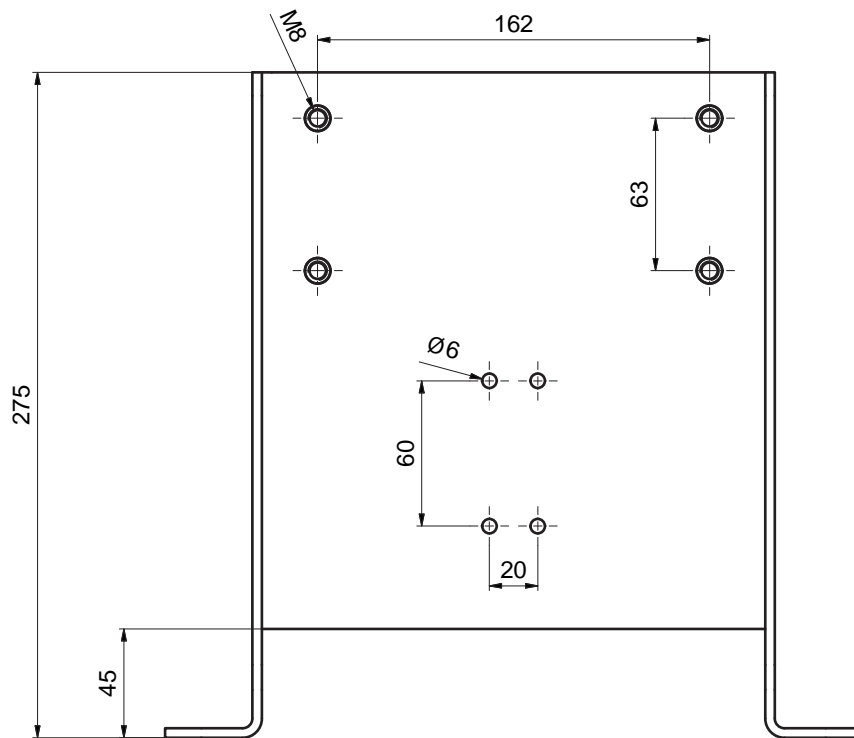

all dimensions in mm

Fig. 15.7: BTF830M mounting bracket

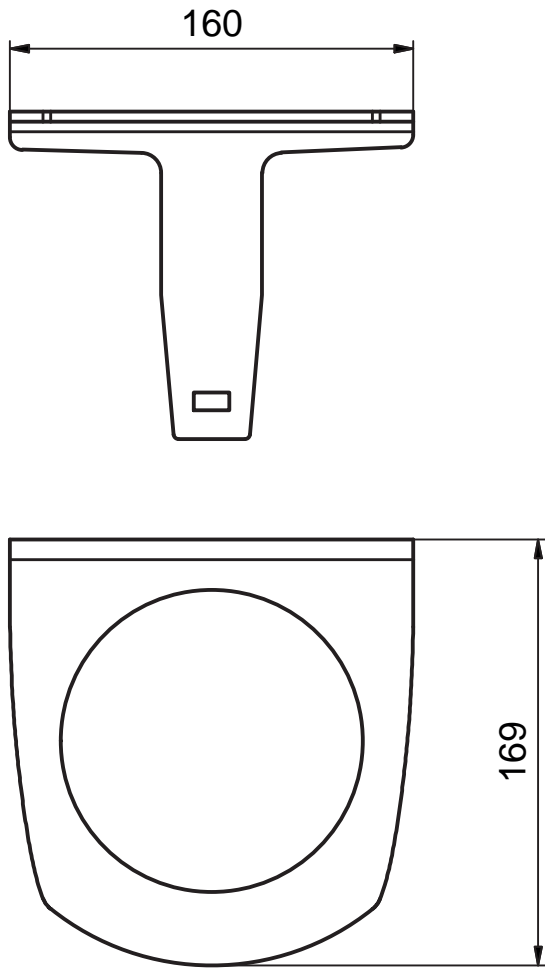

all dimensions in mm

Fig. 15.8: Loop guard BTP800M

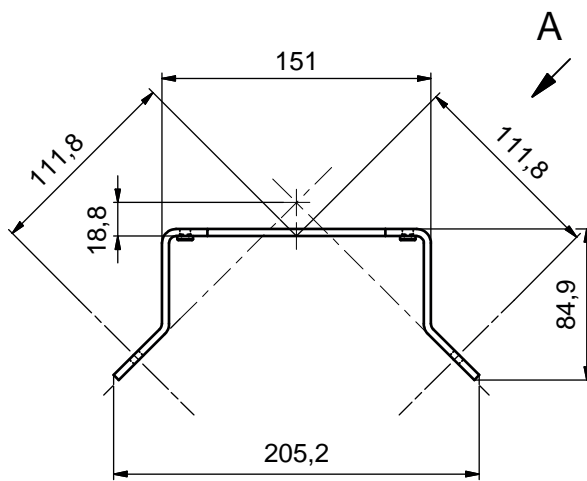

all dimensions in mm

Fig. 15.9: BT840M mounting bracket

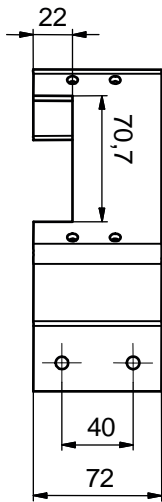

all dimensions in mm

Fig. 15.10: Mounting bracket BT840M, view A

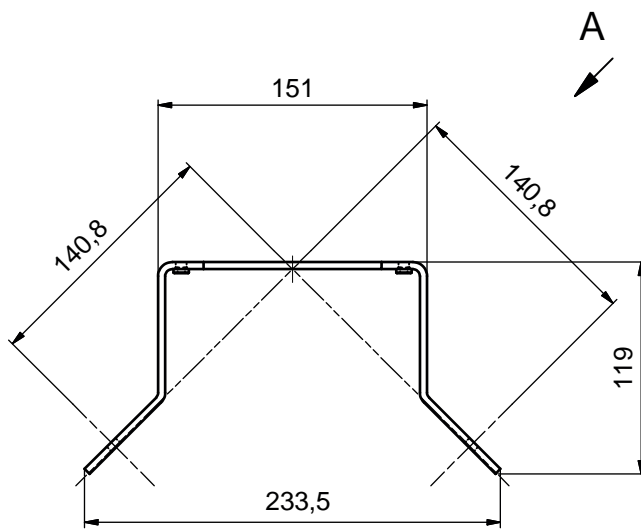

all dimensions in mm

Fig. 15.11: BT856M mounting bracket

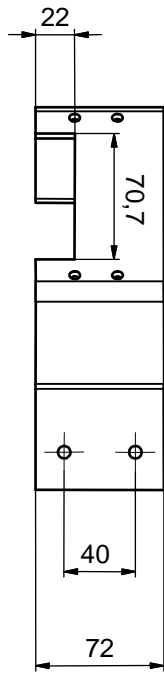

all dimensions in mm

Fig. 15.12: Mounting bracket BT856M, view A

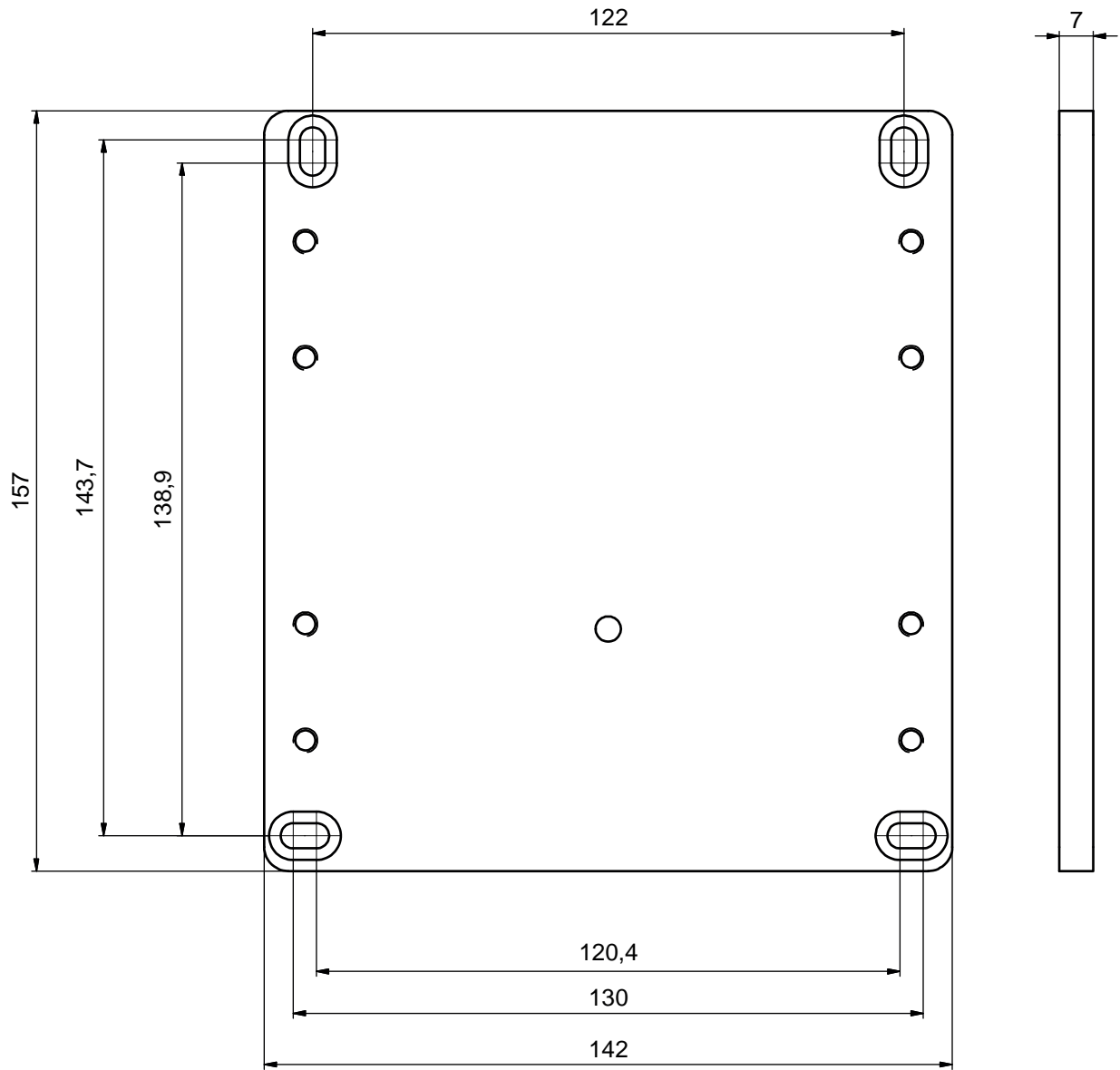

all dimensions in mm

Fig. 15.13: Drilling template for adapter plate, RS4/ROD4 BT800MA

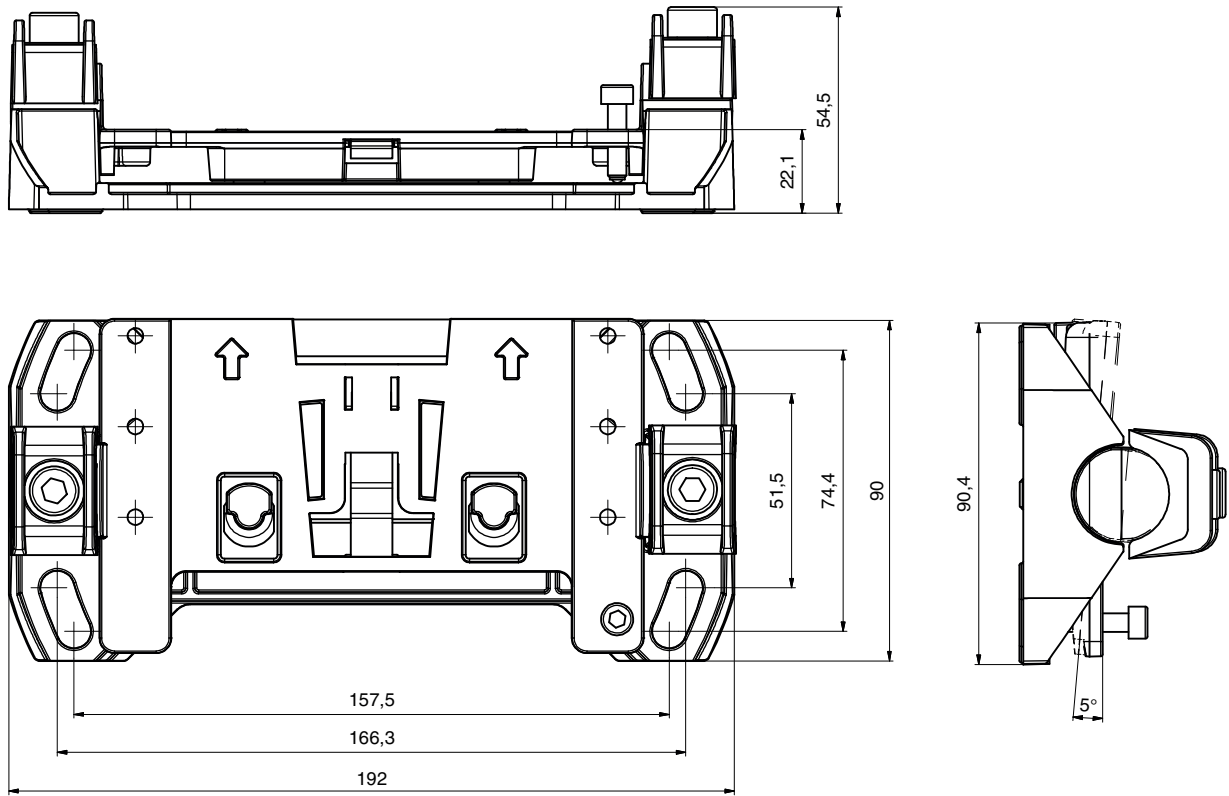

all dimensions in mm

The mounting plate BTU804MA supplements the old mounting system of the RS4/ROD4 for the mounting system BTU800M.

Fig. 15.14: BTU804MA mounting plate

15.4 Representation of safety sensor status

The table lists all logic and electrical signals that are present in the safety sensor. The signal names are used consistently throughout the configuration and diagnostic software (device DTM), in the event log and in the data telegram.

Tab. 15.14: Status profile

Byte	Bit	Signal	Description	Value "0"	Value "1"	Default
0	---	---	Type (model) of status profile. Extensions require new type of status profile	---	---	1
1	---	OP-MODE	Operating mode: <ul style="list-style-type: none"> • 1: Safety mode • 2: Simulation mode 	---	---	1
Messages and OSSDs						
2	7	ERROR	Collective message: Error with switch-off	off	message	0
	6	ALARM	Collective message: Warnings with switch-off (also window warning)	off	message	0
	5	SCREEN	Contamination display for optics cover Warning and switch-off	off	message	0
	4	EDM	EDM collection error	off	message	---
	3	FIELD PAIR	Collective message: Fault detected by field pair selection monitoring	off	message	---
	2	E-STOP	Error with OSSD linkage / E-Stop monitoring	off	message	---
	1	A-OSSD	OSSD state Protective function A	off	on	0
	0	B-OSSD	OSSD state Protective function B	off	on	0
Emergency stop and parking						
3	7	Status-Input-SE	Status of the inputs SE1 and SE2 E-Stop	off	on	0
	6	Mode-PARK	Park request fulfilled	off	parked	0
	5	Reserved	---	---	---	0
	4	Reserved	---	---	---	---
	3	Reserved	---	---	---	---
	2	Reserved	---	---	---	---
	1	Reserved	---	---	---	---
	0	Reserved	---	---	---	---
Electrical signals at sensor connection						

Byte	Bit	Signal	Description	Value "0"	Value "1"	Default
4	7	F1	Control input Input group 0	---	---	0
	6	F2	Control input Input group 0	---	---	0
	5	F3	Control input Input group 0	---	---	0
	4	F4	Control input Input group 0	---	---	---
	3	F5	Control input Input group 0	---	---	---
	2	F6	Control input Input group 1	---	---	---
	1	F7	Control input Input group 1	---	---	---
	0	F8	Control input Input group 1	---	---	---
5	7	F9	Control input Input group 1	---	---	0
	6	F10	Control input Input group 1	---	---	0
	5	RES1	Start input Protective function A	---	---	0
	4	RES2	Start input Protective function B	---	---	---
	3	EA1	EDM input Protective function A	---	---	---
	2	EA2	EDM input Protective function B	---	---	---
	1	EA3	---	---	---	---
	0	EA4	---	---	---	---
6	7	SE1	Linkage input	---	---	0
	6	SE2	Linkage input	---	---	0
	5	PNP-NPN	PNP/NPN changeover	npn	pnp	0
	4	A1	Output	---	---	---
	3	A2	Output	---	---	---
	2	A3	Output	---	---	---
	1	A4	Output	---	---	---
	0	MELD	Output	---	---	---
7	---	Reserved	---	---	---	
8-11 uint32	31-0	SCAN	Consecutive numbering of scans Resetting to 0 by switching off	---	---	value

Byte	Bit	Signal	Description	Value "0"	Value "1"	Default
Protective function A						
12	7	A-ACTIVE	Protective function A is active / configured	off	Active	0
	6	A-WF-VIO	Status of active warning field Protective function A	violation	free	0
	5	A-PF-VIO	Status of active protective field Protective function A	violation	free	0
	4	A-RES	Start/restart interlock active Start Request A	off	Active	0
	3	A-CLEAR	Internal signal OSSD A	off	on	0
	2	Reserved	---	---	---	---
	1	Reserved	---	---	---	---
	0	Reserved	---	---	---	---
Field pair selection A						
13	7-4	A-BANK-SEL	Selected bank A Numbers 1 ... 10	---	---	0
	3-0	A-PAIR-SEL 1	First selected field pair A Numbers 1 ... 10	---	---	0
14	7-4	A-PAIR-SEL 2	Second selected field pair A Numbers 1 ... 10	---	---	0
	3-0	A-PAIR-SEL 3	Third selected field pair A Numbers 1 ... 10	---	---	0
Output signals A						
15	7	A-WF-VIO-SEG-1	Status of active warning field segment Protective function A	violation	free	0
	6	A-WF-VIO-SEG-2	Status of active warning field segment Protective function A	violation	free	0
	5	A-PF-VIO-SEG-1	Status of active protective field segment Protective function A	violation	free	0
	4	A-PF-VIO-SEG-2	Status of active protective field segment Protective function A	violation	free	0
	3	A-FP-SEL-1	Defined field pair selected Protective function A	off	selected	0
	2	A-FP-SEL-2	Defined field pair selected Protective function A	off	selected	0
	1	Reserved	---	---	---	---
	0	Reserved	---	---	---	---

16 Standards and legal regulations

In particular, the current version of the following national and international legal regulations apply for commissioning, technical tests and handling of safety sensors:

- Machinery Directive
- Low Voltage Directive
- Electromagnetic compatibility
- Use of Work Equipment Directive
- Directive on the restriction of the use of certain hazardous substances in electrical and electronic equipment
- OSHA
- Vibration IEC/EN 60068-2-6
- Eye safety (measurement laser) IEC/EN 60825-1
- Safety regulations
- Accident-prevention regulations and safety rules
- Ordinance on Industrial Safety and Health and employment protection act
- Product Safety Law (ProdSG)
- Standards for risk assessment, e.g.
 - EN ISO 12100
 - EN ISO 13849-1, -2
 - IEC/EN 61508-1 to -7
 - EN IEC 62061
 - IEC/EN 60204-1
- EN ISO 13849-1
- EN ISO 13855
- EN IEC 61496-3
- EN ISO 3691-4
- EN IEC 62046

17 Order guide and accessories

Scope of delivery

- 1 self-adhesive notice sign "Important notes and notes for the machine operator"
- 1 original operating instructions "Safe implementation and operation" (PDF file on data carrier)

17.1 Type overview

Tab. 17.1: Safety laser scanner

Part no.	Article	Description
53800200	RSL311-S/CU308-M12	1 OSSD pair; 1 field pair; 3 IOs; protective field range max. 3.0 m Connection: M12, 8-pin Ethernet: M12, 4-pin

Tab. 17.2: Spare parts – assemblies

Part no.	Article	Description
53800172	RSL311-S	Scanner unit 1 OSSD pair; 1 field pair; 3 IOs; protective field range max. 3.0 m
53800173	CU308-M12	Connection unit Connection: M12, 8-pin Ethernet: M12, 4-pin

17.2 Accessories – connection technology

Tab. 17.3: Connection cables

Part no.	Article	Description
50135128	KD S-M12-8A-P1-050	Connection cable, 8-pin, 5 m long
50135129	KD S-M12-8A-P1-100	Connection cable, 8-pin, 10 m long
50135130	KD S-M12-8A-P1-150	Connection cable, 8-pin, 15 m long

Tab. 17.4: Interconnection cables

Part no.	Article	Description
50135080	KSS ET-M12-4A-RJ45-A-P7-020	Interconnection cable RJ45, length 2 m
50135081	KSS ET-M12-4A-RJ45-A-P7-050	Interconnection cable RJ45, length 5 m
50135082	KSS ET-M12-4A-RJ45-A-P7-100	Interconnection cable RJ45, length 10 m
50135083	KSS ET-M12-4A-RJ45-A-P7-150	Interconnection cable RJ45, length 15 m
50135084	KSS ET-M12-4A-RJ45-A-P7-300	Interconnection cable RJ45, length 30 m

Tab. 17.5: Adapter

Part no.	Article	Description
50134656	RSL400 M12 adapter	Adapter for the simple connection of an Ethernet cable to the front side of the device

17.3 Accessories – mounting systems

Tab. 17.6: Mounting systems

Part no.	Article	Description
53800130	BTU800M	Laser scanner mounting system for vertical and horizontal alignment
53800131	BTP800M	Loop guard for optics cover Only in combination with BTU800M
53800132	BTF815M	Mounting bracket for floor mounting; scanning height 150 mm Mounting of safety sensor only in combination with BTU800M
53800133	BTF830M	Mounting bracket for floor mounting; scanning height 300 mm Mounting of safety sensor only in combination with BTU800M
53800134	BT840M	Mounting bracket for corner mounting on posts (chamfered corner) Direct mounting of the safety sensor
53800135	BT856M	Mounting bracket for corner mounting on posts Direct mounting of the safety sensor
53800136	BTU804MA	Mounting plate for mounting system RS4 / ROD4
53800137	BT800MA	Drilling template for adapter plate, RS4/ROD4
53800138	BTF815-30M	Mounting bracket for floor mounting; adjustable scanning height 75 mm – 375 mm Mounting of safety sensor only in combination with BTU800M

17.4 Accessories – cleaning sets

Tab. 17.7: Cleaning sets

Part no.	Article	Description
430400	RS4-clean-Set1	Cleaning set with <ul style="list-style-type: none"> • Cleaning fluid for plastic, 150 ml • Cleaning cloths, 25x, soft, fuzz-free
430410	RS4-clean-Set2	Cleaning set with <ul style="list-style-type: none"> • Cleaning fluid for plastic, 1,000 ml • Cleaning cloths, 100x, soft, fuzz-free

18 EC Declaration of Conformity

The safety laser scanners of the RSL 300 series have been developed and manufactured in accordance with the applicable European standards and directives.

NOTICE	
	<p>You can download the EC Declaration of Conformity from the Leuze website.</p> <ul style="list-style-type: none">↳ Call up the Leuze website: www.leuze.com.↳ Enter the type designation or part number of the device as the search term. The part number can be found on the name plate of the device under the "Part No." entry.↳ The documents can be found on the product page for the device under the <i>Downloads</i> tab.