

## Technical data sheet

### Camera

Part no.: 50147807

LCAM 308 C6F-XX

#### Contents

- Technical data
- Dimensioned drawings
- Electrical connection
- Diagrams
- Accessories



For illustration purposes only



## Technical data

### Basic data

Series	LCAM
Suitable for	Use in intralogistics applications
Chip	CMOS

### Functions

Functions	Real-time clock
Software functions	Image memory
	Image transfer
	Livestream transmission
	REST-API
	Video memory

### Optical data

Working range, additional note	Motor-driven focus adjustment
Working range	500 mm ... ∞
Camera resolution, horizontal	1,280 px
Camera resolution, vertical	720 px
Focal length	3 mm
Chip size	1/4 in
Frame rate (images per second), max.	24 pieces per second
Opening angle, x-axis	62 °
Opening angle, y-axis	48 °
Camera type	Color

### Electrical data

#### Performance data

Supply voltage $U_B$	18 ... 28 V, DC
Power consumption, max.	5.6 W, (heating inactive) / 20 W, (heating active)

### Interface

Type	Ethernet
<b>Ethernet</b>	
Address assignment	DHCP
	Manual address assignment
Transmission speed	10 Mbit/s
	100 Mbit/s
Function	Process
	Service
Switch functionality	None
Transmission protocol	TCP/IP, RTP/RTSP, UDP, NTP

### Connection

#### Connection 1

Function	Configuration interface
	Data interface
	Service interface
Type of connection	Connector
Thread size	M12
No. of pins	4 -pin
Encoding	D-coded

#### Connection 2

Function	Signal IN
	Voltage supply
Type of connection	Connector
Thread size	M12
No. of pins	4 -pin
Encoding	A-coded

### Mechanical data

Dimension (W x H x L)	84.6 mm x 38.3 mm x 114 mm
Housing material	Metal
Lens cover material	Plastic (PMMA+) with scratch-resistant Indium protective coating
Net weight	300 g
Type of fastening	Mounting thread
	Via optional mounting device

### Environmental data

Ambient temperature, operation	-30 ... 50 °C
--------------------------------	---------------

### Certifications

Degree of protection	IP 65
----------------------	-------

### Classification

Customs tariff number	90021100
ECLASS 5.1.4	27310101
ECLASS 8.0	27310101
ECLASS 9.0	27310201
ECLASS 10.0	27310101
ECLASS 11.0	27310101
ECLASS 12.0	27310101
ECLASS 13.0	27310101
ECLASS 14.0	27310101
ETIM 5.0	EC002550
ETIM 6.0	EC002550
ETIM 7.0	EC002550
ETIM 8.0	EC002550
ETIM 9.0	EC002550

# Dimensioned drawings

All dimensions in millimeters

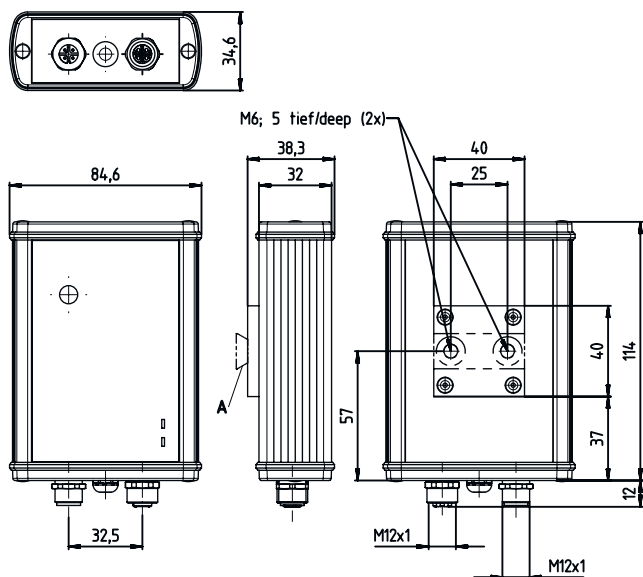

A BTC 0310M-DT is required when using BT 56, BT 56-1, BT 59, BTU 0300M-W

## Electrical connection

### Connection 1

<b>Function</b>	Configuration interface
	Data interface
	Service interface
<b>Type of connection</b>	Connector
<b>Thread size</b>	M12
<b>Type</b>	Female
<b>Material</b>	Metal
<b>No. of pins</b>	4 -pin
<b>Encoding</b>	D-coded

Pin	Pin assignment
1	Tx+
2	Rx+
3	Tx-
4	Rx-

### Connection 2

<b>Function</b>	Signal IN
	Voltage supply
<b>Type of connection</b>	Connector
<b>Thread size</b>	M12
<b>Type</b>	Male
<b>Material</b>	Metal
<b>No. of pins</b>	4 -pin
<b>Encoding</b>	A-coded

# Electrical connection

Pin	Pin assignment
1	V+
2	Trigger IN
3	GND
4	n.c.

## Diagrams

Maximum horizontal field of view with setting 0/180°

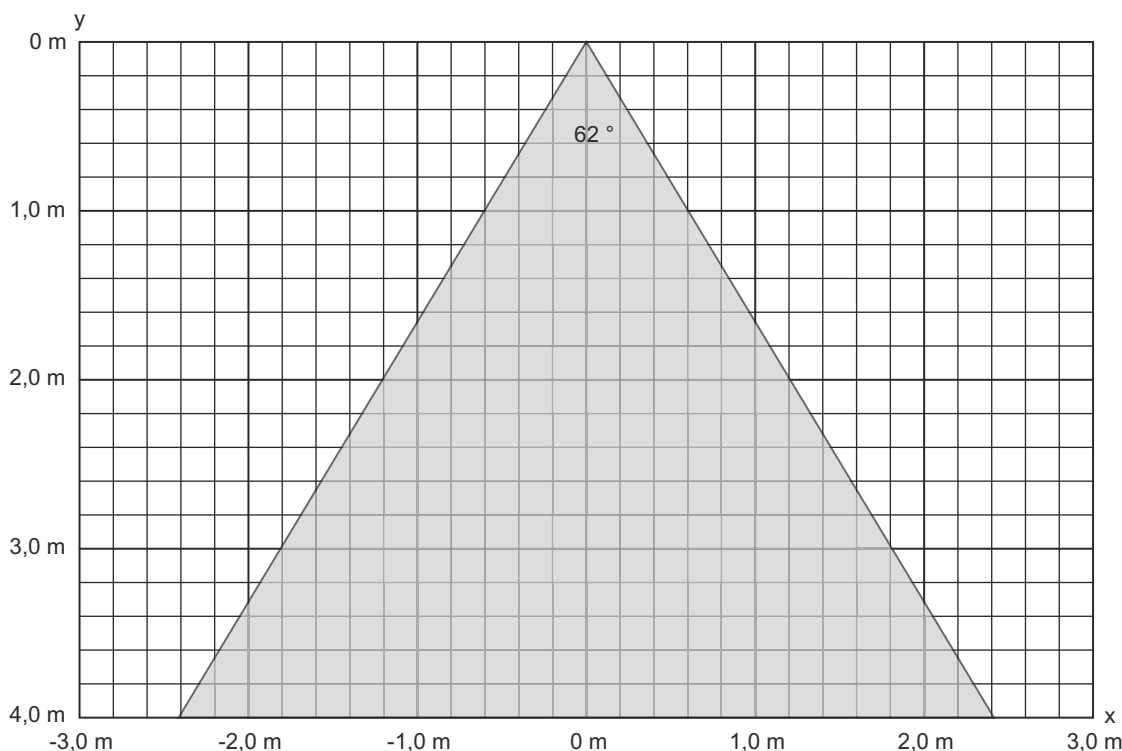

## Accessories

### Connection technology - Connection unit

	Part no.	Designation	Article	Description
	50135196	MD 708-21-42/D4-12	Ethernet switch	Supply voltage: 18 ... 30 V Interface: Ethernet Connections: 5 Piece(s) Connections for voltage supply: 1 Piece(s) Interface connections: 4 Piece(s) Degree of protection: IP 67
	50135197	MD 708-21-82/D4-12	Ethernet switch	Supply voltage: 18 ... 30 V Interface: Ethernet Connections: 9 Piece(s) Connections for voltage supply: 1 Piece(s) Interface connections: 8 Piece(s) Degree of protection: IP 67

## Accessories

### Connection technology - Connection cables

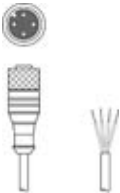
	Part no.	Designation	Article	Description
	50130657	KD U-M12-4A-P1-050	Connection cable	Connection 1: Connector, M12, Axial, Female, A-coded, 4 -pin Connector, LED: No Connection 2: Open end Shielded: No Cable length: 5.000 mm Sheathing material: PUR

### Connection technology - Interconnection cables

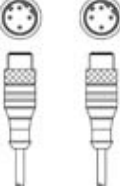
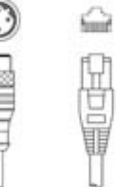
	Part no.	Designation	Article	Description
	50130743	KDS U-M12-4A-M12-4A-P1-050	Interconnection cable	Connection 1: Connector, M12, Axial, Female, A-coded, 4 -pin Connection 2: Connector, M12, Axial, Male, A-coded, 4 -pin Shielded: No Cable length: 5,000 mm Sheathing material: PUR
	50137077	KSS ET-M12-4A-M12-4A-P7-020	Interconnection cable	Suitable for interface: Ethernet Connection 1: Connector, M12, Axial, Male, D-coded, 4 -pin Connection 2: Connector, M12, Axial, Male, D-coded, 4 -pin Shielded: Yes Cable length: 2.000 mm Sheathing material: PUR
	50135081	KSS ET-M12-4A-RJ45-A-P7-050	Interconnection cable	Suitable for interface: Ethernet Connection 1: Connector, M12, Axial, Male, D-coded, 4 -pin Connection 2: RJ45 Shielded: Yes Cable length: 5,000 mm Sheathing material: PUR

### Connection technology - Connectors



	Part no.	Designation	Article	Description
	50137169	S GB-RJ45-8A-K-SK	Connector	Suitable for interface: Ethernet Connection: RJ45

### Mounting technology - Mounting brackets



	Part no.	Designation	Article	Description
	50121433	BT 300 W	Mounting device	Design of mounting device: Angle, L-shape Fastening, at system: Through-hole mounting Mounting bracket, at device: Screw type Type of mounting device: Adjustable Material: Metal

## Accessories

### Mounting technology - Rod mounts

	Part no.	Designation	Article	Description
	50121434	BT 300 - 1	Mounting device	Design of mounting device: Mounting system Fastening, at system: For 10-16 mm rods Mounting bracket, at device: Screw type Type of mounting device: Turning, 360°, Adjustable Material: Metal
	50027375	BT 56	Mounting device	Functions: Static applications Design of mounting device: Mounting system Fastening, at system: For 16 mm rod, For 18 mm rod, For 20 mm rod Mounting bracket, at device: Clampable Material: Metal Tightening torque of the clamping jaws: 8 N·m
	50121435	BT 56 - 1	Mounting device	Functions: Static applications Design of mounting device: Mounting system Fastening, at system: For 12 mm rod, For 14 mm rod, For 16 mm rod Mounting bracket, at device: Clampable Material: Metal Tightening torque of the clamping jaws: 8 N·m

### Mounting technology - Other

	Part no.	Designation	Article	Description
	50111224	BT 59	Mounting bracket	Fastening, at system: Groove mounting Mounting bracket, at device: Clampable Material: Metal Shock absorber: No
	50148152	BTC 0310M-DT	Mounting device	Design of mounting device: Mounting clamp Fastening, at system: Clampable Mounting bracket, at device: Screw type Material: Metal Shock absorber: No
	50124941	BTU 0300M-W	Mounting device	Fastening, at system: Through-hole mounting Mounting bracket, at device: Clampable, Groove mounting, Suited for M4 screws Material: Metal Shock absorber: No

### Configuration devices

	Part no.	Designation	Article	Description
	50124709	PA1/XTSX-M12	Programming unit	Functions: Teach-in activation Connection: Connector, M12, 5 -pin

## Accessories

### Note



🔗 A list with all available accessories can be found on the Leuze website in the Download tab of the article detailed page.