

Technical data sheet

Optical positioning sensor

Part no.: 50151445
AMS 108i 40

Contents

- Technical data
- Dimensioned drawings
- Electrical connection
- Diagrams
- Operation and display
- Part number code
- Notes
- Further information
- Accessories



For illustration purposes only



Technical data

Basic data

| | |
|-------------|--|
| Series | AMS 100i |
| Application | Collision protection of cranes / gantry cranes Positioning of electroplating plants Positioning of skilnet systems and side-tracking skates Positioning of stacker cranes |
| Order guide | Reflective tape must be ordered separately |

Characteristic parameters

| | |
|------|----------|
| MTTF | 27 years |
|------|----------|

Optical data

| | |
|--------------------------------------|------------------------|
| Light source | Laser, Red |
| Wavelength | 660 nm |
| Laser class | 2, IEC/EN 60825-1:2014 |
| Max. laser power | 0.004 W |
| Transmitted-signal shape | Modulated |
| Pulse duration | 0.8 µs |
| Light spot size [at sensor distance] | 40 mm [40,000 mm] |
| Type of light spot geometry | Round |

Measurement data

| | |
|--|--|
| Measurement range | 100 ... 40,000 mm |
| Resolution | 0.001 ... 10 mm |
| Accuracy | 2 mm, +/- |
| Reproducibility (3 sigma), short range | 0.9 mm (with measurement range up to 500 mm) |
| Reproducibility (3 sigma), distant range | 0.6 mm (with measurement range from 500 mm) |
| Measurement value output | 1 ms |
| Temperature drift, absolute (mm/10K) | ≤ 1 mm/10K |
| Max. traverse rate | 10 m/s |

Electrical data

| | |
|---------------------------|-----------------|
| Protective circuit | No information |
| Performance data | |
| Supply voltage U_B | 18 ... 30 V, DC |
| Current consumption, max. | 250 mA |

Time behavior

| | |
|---------------|--|
| Response time | 14 ms, Basis for contouring error calculation = 7 ms |
|---------------|--|

Interface

| | |
|------|-----------------|
| Type | EtherNet TCP/IP |
|------|-----------------|

Connection

| | |
|-----------------------|------------|
| Number of connections | 2 Piece(s) |
|-----------------------|------------|

Connection 1

| | |
|-----------------------|---|
| Function | Signal IN Signal OUT Voltage supply |
| Type of connection | Connector |
| Designation on device | XD1 PWR |
| Thread size | M12 |
| Type | Male |
| Material | Metal |
| No. of pins | 5 -pin |
| Encoding | A-coded |

Connection 2

| | |
|-----------------------|---|
| Function | EtherNet TCP/IP, UDP Service interface |
| Type of connection | Connector |
| Designation on device | XF1 NET / XF0 service |
| Thread size | M12 |
| Type | Female |
| No. of pins | 4 -pin |
| Encoding | D-coded |

Mechanical data

| | |
|-----------------------|-------------------------|
| Design | Cubic |
| Dimension (W x H x L) | 70 mm x 139 mm x 118 mm |
| Housing material | Metal |
| Metal housing | Diecast aluminum |
| Lens cover material | Glass |
| Net weight | 600 g |
| Housing color | Gray Red |
| Type of fastening | Through-hole mounting |

Operation and display

| | |
|----------------------|-------------------|
| Type of display | LC Display LED |
| Number of LEDs | 2 Piece(s) |
| Operational controls | Membrane keyboard |

Environmental data

| | |
|------------------------------------|---------------|
| Ambient temperature, operation | -5 ... 60 °C |
| Ambient temperature, storage | -30 ... 70 °C |
| Relative humidity (non-condensing) | 90 % |

Certifications

| | |
|----------------------|-------|
| Degree of protection | IP 65 |
| Protection class | III |
| Approvals | UL |

Technical data

| | |
|-----------------------|----------|
| Customs tariff number | 90318020 |
| ECLASS 5.1.4 | 27270801 |
| ECLASS 8.0 | 27270801 |
| ECLASS 9.0 | 27270801 |
| ECLASS 10.0 | 27270801 |
| ECLASS 11.0 | 27270801 |
| ECLASS 12.0 | 27270916 |
| ECLASS 13.0 | 27270916 |
| ECLASS 14.0 | 27270916 |
| ECLASS 15.0 | 27270916 |
| ECLASS 16.0 | 27270916 |
| ETIM 5.0 | EC001825 |
| ETIM 6.0 | EC001825 |
| ETIM 7.0 | EC001825 |
| ETIM 8.0 | EC001825 |
| ETIM 9.0 | EC001825 |
| ETIM 10.0 | EC001825 |
| UNSPSC 26.08 | 39121528 |

Dimensioned drawings

All dimensions in millimeters

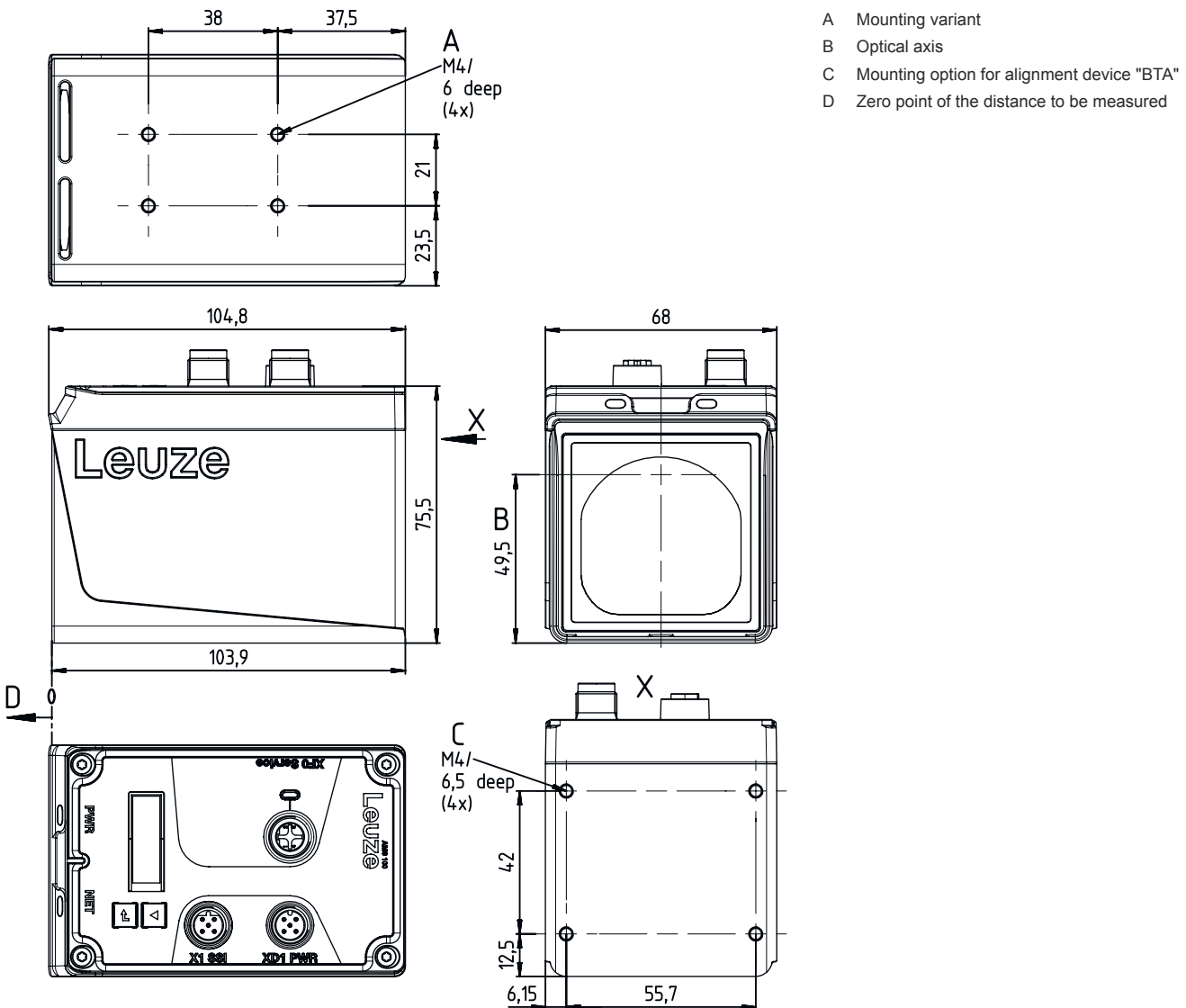

- A Mounting variant
- B Optical axis
- C Mounting option for alignment device "BTA"
- D Zero point of the distance to be measured

Electrical connection

Connection 1

XD1 PWR

| | |
|--------------------|----------------|
| Function | Signal IN |
| | Signal OUT |
| | Voltage supply |
| Type of connection | Connector |
| Thread size | M12 |
| Type | Male |
| Material | Metal |
| No. of pins | 5 -pin |
| Encoding | A-coded |

Electrical connection

| Pin | Pin assignment |
|-----|----------------|
| 1 | V+ |
| 2 | I/O 1 |
| 3 | GND |
| 4 | I/O 2 |
| 5 | FE |

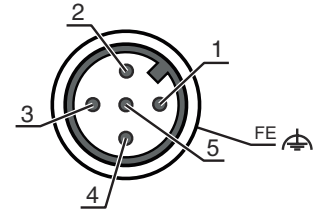

| Connection 2 | XF1 NET / XF0 service |
|--------------------|---|
| Function | EtherNet TCP/IP, UDP Service interface |
| Type of connection | Connector |
| Thread size | M12 |
| Type | Female |
| Material | Metal |
| No. of pins | 4 -pin |
| Encoding | D-coded |

| Pin | Pin assignment |
|-----|----------------|
| 1 | TD+ |
| 2 | RD+ |
| 3 | TD- |
| 4 | RD- |

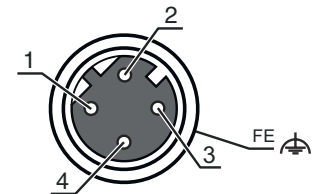

Diagrams

Typ. reproducibility

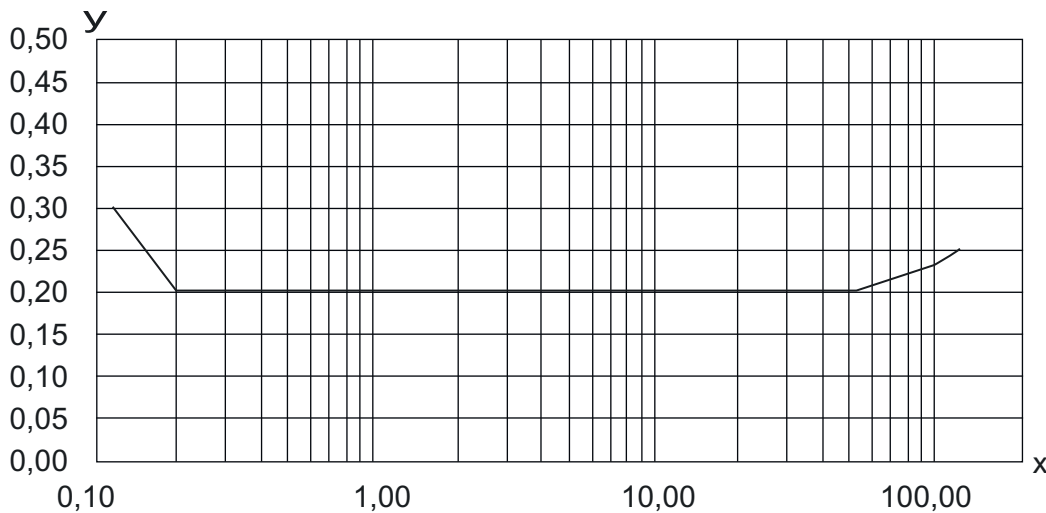

X Reproducibility [mm]
 Y Distance [m]
 A 1 sigma (max) / mm

— A

Operation and display

| LED | Display | Meaning |
|-------|--------------------------|--|
| 1 PWR | Off | No supply voltage |
| | Green, flashing | Voltage connected / no measurement value output / initialization running |
| | Green, continuous light | Device OK, measurement value output |
| | Red, flashing | Device OK, warning set |
| | Red, continuous light | No measurement value output |
| 2 BUS | Orange, continuous light | No data transmission |
| | Off | No supply voltage |
| | Green, continuous light | Data transmission active |
| | Green, flashing | Device ok, initialization phase |

Part number code

Part designation: AMS 1XXi YYY Z AAA

| | |
|------|---|
| AMS | Series AMS: absolute measurement system |
| 1XXi | Interface 108i: EtherNet TCP/IP |
| YYY | Operating range 40: max. operating range in m 120: max. operating range in m |
| AAA | Special equipment BTA: adjustable mounting device |

Note



A list with all available device types can be found on the Leuze website at www.leuze.com.

Notes



Observe intended use!



- ⌘ This product is not a safety sensor and is not intended as personnel protection.
- ⌘ The product may only be put into operation by competent persons.
- ⌘ Only use the product in accordance with its intended use.

Notes

! ATTENTION! LASER RADIATION – CLASS 2 LASER PRODUCT

Do not stare into beam!
 The device satisfies the requirements of IEC/EN 60825-1:2014 safety regulations for a product of **laser class 2** as well as the U.S. 21 CFR 1040.10 regulations with deviations corresponding to Laser Notice No. 56 from May 08, 2019.

- ⌘ Never look directly into the laser beam or in the direction of reflected laser beams! If you look into the beam path over a longer time period, there is a risk of injury to the retina.
- ⌘ Do not point the laser beam of the device at persons!
- ⌘ Interrupt the laser beam using a non-transparent, non-reflective object if the laser beam is accidentally directed towards a person.
- ⌘ When mounting and aligning the device, avoid reflections of the laser beam off reflective surfaces!
- ⌘ CAUTION! The use of operating and adjusting devices other than those specified here or the carrying out of differing procedures may lead to dangerous exposure to radiation!
- ⌘ Observe the applicable statutory and local laser protection regulations.
- ⌘ The device must not be tampered with and must not be changed in any way.
 There are no user-serviceable parts inside the device.
 Repairs must only be performed by Leuze electronic GmbH + Co. KG.

NOTE

Affix laser information and warning signs!
 Laser information and warning signs are affixed to the device. In addition, self-adhesive laser information and warning signs (stick-on labels) are supplied in several languages.

- ⌘ Affix the laser information sheet to the device in the language appropriate for the place of use. When using the device in the US, use the stick-on label with the "Complies with 21 CFR 1040.10" note.
- ⌘ Affix the laser information and warning signs near the device if no signs are attached to the device (e.g. because the device is too small) or if the attached laser information and warning signs are concealed due to the installation position.
- ⌘ Affix the laser information and warning signs so that they are legible without exposing the reader to the laser radiation of the device or other optical radiation.

Further information

- For UL applications, use is only permitted in Class 2 circuits in accordance with the NEC (National Electric Code).
- Use as safety-related component within the safety function is possible, if the component combination is designed correspondingly by the machine manufacturer.



Accessories

Connection technology - Connection cables

| | Part no. | Designation | Article | Description |
|--|----------|---------------------|------------------|---|
| | 50132079 | KD U-M12-5A-V1-050 | Connection cable | Application: Chemical resistant Connection 1: Connector, M12, Axial, Female, A-coded, 5 -pin Connector, LED: No Connection 2: Open end Shielded: No Cable length: 5,000 mm Sheathing material: PVC |
| | 50135077 | KS ET-M12-4A-P7-300 | Connection cable | Application: Oil and lubricant resistant Suitable for interface: Ethernet Connection 1: Connector, M12, Axial, Male, D-coded, 4 -pin Connector, LED: No Connection 2: Open end Shielded: Yes Cable length: 30,000 mm Sheathing material: PUR |

Accessories

Mounting technology - Other

| | Part no. | Designation | Article | Description |
|---|----------|--------------|-----------------|---|
|  | 50144968 | BT 0100M | Mounting device | Design of mounting device: Mounting plate Fastening, at system: Groove mounting, Through-hole mounting Mounting bracket, at device: Screw type Material: Metal |
|  | 50151594 | BTA 0100 M.5 | Mounting device | Fastening, at system: Through-hole mounting Mounting bracket, at device: Screw type Type of mounting device: Adjustable Material: Stainless steel |
|  | 50144385 | BTA 0100M | Mounting device | Fastening, at system: Through-hole mounting Mounting bracket, at device: Screw type Type of mounting device: Adjustable Material: Aluminum, Steel |

Deflecting mirrors

| | Part no. | Designation | Article | Description |
|--|----------|-------------|-------------------|-------------------------------|
|  | 50035630 | US 1 OMS | Deflecting mirror | Type of fastening: Screw type |

Services

| | Part no. | Designation | Article | Description |
|--|----------|-------------|------------------|--|
|  | S981001 | CS10-S-110 | Start-up support | Details: Performed at location of customer's choosing, duration: max. 10 hours. Conditions: Devices and connection cables are already mounted, price not including travel costs and, if applicable, accommodation expenses. |
|  | S981005 | CS10-T-110 | Product training | Details: Location and content to be agreed upon, duration: max. 10 hours. Conditions: Price not including travel costs and, if applicable, accommodation expenses. |

Note



A list with all available accessories can be found on the Leuze website in the Download tab of the article detailed page.