

## Technical data sheet Stationary bar code reader

Part no.: 50132854

BCL 601i SF 102

### Contents

- Technical data
- Dimensioned drawings
- Electrical connection
- Diagrams
- Operation and display
- Part number code
- Notes
- Accessories



For illustration purposes only



CDRH



UK  
CA

## Technical data

### Basic data

Series	BCL 600i
--------	----------

### Functions

Functions	Alignment mode
	AutoConfig
	AutoControl
	AutoReflAct
	Code fragment technology
	LED indicator
	Reference code comparison

### Characteristic parameters

MTTF	93 years
------	----------

### Read data

Code types, readable	2/5 Interleaved
	Codabar
	Code 128
	Code 39
	Code 93
	EAN 128
	EAN 8/13
	EAN Addendum
	GS1 Databar Expanded
	GS1 Databar Limited
	GS1 Databar Omnidirectional
	UPC

Scanning rate, typical	800 scans/s
------------------------	-------------

Bar codes per reading gate, max. number	64 Piece(s)
---	-------------

### Optical data

Reading distance	450 ... 1,450 mm
Light source	Laser, Blue
Wavelength	405 nm
Laser class	2, IEC/EN 60825-1:2014
Transmitted-signal shape	Continuous
Usable opening angle (reading field opening)	60 °
Bar code contrast (PCS)	60 %
Modulus size	0.3 ... 0.5 mm
Reading method	Line scanner
Beam deflection	Via rotating polygon wheel
Light beam exit	Front

### Electrical data

Protective circuit	Polarity reversal protection
--------------------	------------------------------

#### Performance data

Supply voltage $U_B$	10 ... 30 V, DC
----------------------	-----------------

Power consumption, max.	10 W
-------------------------	------

### Inputs/outputs selectable

Output current, max.	60 mA
----------------------	-------

Number of inputs/outputs selectable	4 Piece(s)
-------------------------------------	------------

Voltage type, outputs	DC
-----------------------	----

Switching voltage, outputs	Typ. $U_B / 0 V$
----------------------------	------------------

Voltage type, inputs	DC
----------------------	----

Switching voltage, inputs	Typ. $U_B / 0 V$
---------------------------	------------------

Input current, max.	8 mA
---------------------	------

### Interface

Type	RS 485
------	--------

#### RS 485

Function	Process
----------	---------

Transmission speed	4,800 ... 115,400 Bd
--------------------	----------------------

Data format	Adjustable
-------------	------------

Start bit	1
-----------	---

Data bit	7, 8, 9 data bits
----------	-------------------

Stop bit	1, 2 stop bits
----------	----------------

Parity	Adjustable
--------	------------

Transmission protocol	Adjustable
-----------------------	------------

Data encoding	ASCII
---------------	-------

### Service interface

Type	USB
------	-----

#### USB

Function	Configuration via software
----------	----------------------------

Service

### Connection

Number of connections	5 Piece(s)
-----------------------	------------

#### Connection 1

Function	Service interface
----------	-------------------

Type of connection	USB
--------------------	-----

Designation on device	SERVICE
-----------------------	---------

Connector type	USB 2.0 Standard-A
----------------	--------------------

#### Connection 2

Function	Signal IN
----------	-----------

Signal OUT

Type of connection	Connector
--------------------	-----------

Designation on device	SW IN/OUT
-----------------------	-----------

Thread size	M12
-------------	-----

Type	Male
------	------

Material	Metal
----------	-------

No. of pins	5 -pin
-------------	--------

Encoding	A-coded
----------	---------

#### Connection 3

Function	Signal IN
----------	-----------

Signal OUT

Voltage supply

Type of connection	Connector
--------------------	-----------

Designation on device	PWR
-----------------------	-----

Thread size	M12
-------------	-----

Type	Female
------	--------

Material	Metal
----------	-------

No. of pins	5 -pin
-------------	--------

Encoding	A-coded
----------	---------

## Technical data

### Connection 4

Function	BUS IN
Type of connection	Connector
Designation on device	HOST / BUS IN
Thread size	M12
Type	Male
Material	Metal
No. of pins	5 -pin
Encoding	B-coded

### Connection 5

Function	BUS OUT
Type of connection	Connector
Designation on device	BUS OUT
Thread size	M12
Type	Male
No. of pins	5 -pin

### Mechanical data

Design	Cubic
Dimension (W x H x L)	123.5 mm x 63 mm x 106.5 mm
Housing material	Metal
Metal housing	Diecast aluminum
Lens cover material	Glass
Net weight	1,100 g
Housing color	Red Silver
Type of fastening	Dovetail grooves Mounting thread Via optional mounting device

### Operation and display

Type of display	LED Monochromatic graphical display, 128x64 pixel, with background lighting
Number of LEDs	2 Piece(s)
Type of configuration	Via web browser
Operational controls	Button(s)

### Environmental data

Ambient temperature, operation	0 ... 40 °C
Ambient temperature, storage	-20 ... +70 °C
Relative humidity (non-condensing)	90 %
Extraneous light tolerance on the bar code, max.	2,000 lx

### Certifications

Degree of protection	IP 65
Protection class	III
Approvals	c UL US
Test procedure for EMC in accordance with standard	EN 55022 EN 61000-4-2, -3, -4, -6
Test procedure for shock in accordance with standard	IEC 60068-2-27, test Ea
Test procedure for continuous shock in accordance with standard	IEC 60068-2-29, test Eb
Test procedure for vibration in accordance with standard	IEC 60068-2-6, test Fc

### Classification

Customs tariff number	84719000
ECLASS 5.1.4	27280102
ECLASS 8.0	27280102
ECLASS 9.0	27280102
ECLASS 10.0	27280102
ECLASS 11.0	27280102
ECLASS 12.0	27280102
ECLASS 13.0	27280102
ECLASS 14.0	27280102
ECLASS 15.0	27280102
ECLASS 16.0	27280102
ETIM 5.0	EC002550
ETIM 6.0	EC002550
ETIM 7.0	EC002550
ETIM 8.0	EC002550
ETIM 9.0	EC002550
ETIM 10.0	EC002550
UNSPSC 26.08	43211701

# Dimensioned drawings

All dimensions in millimeters



## Electrical connection

### Connection 1

### SERVICE

Function	Service interface
Type of connection	USB
Connector type	USB 2.0 Standard-A

Pin	Pin assignment
1	+5 V DC
2	DATA-
3	DATA+
4	GND

## Electrical connection

### Connection 2

### SW IN/OUT

Function	Signal IN Signal OUT
Type of connection	Connector
Thread size	M12
Type	Male
Material	Metal
No. of pins	5 -pin
Encoding	A-coded

Pin	Pin assignment
1	VOUT
2	SWIO 1
3	GND
4	SWIO 2
5	FE

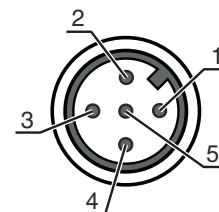

### Connection 3

### PWR

Function	Signal IN Signal OUT Voltage supply
Type of connection	Connector
Thread size	M12
Type	Female
Material	Metal
No. of pins	5 -pin
Encoding	A-coded

Pin	Pin assignment
1	VIN
2	SWIO 3
3	GND
4	SWIO 4
5	FE



### Connection 4

### HOST / BUS IN

Function	BUS IN
Type of connection	Connector
Thread size	M12
Type	Male
Material	Metal
No. of pins	5 -pin
Encoding	B-coded

Pin	Pin assignment
1	Res.
2	RS 485 B
3	GND 485
4	RS 485 A
5	FE

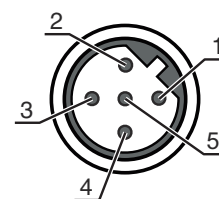

# Electrical connection

## Connection 5

## BUS OUT

Function	BUS OUT
Type of connection	Connector
Thread size	M12
Type	Male
Material	Metal
No. of pins	5 -pin
Encoding	B-coded

Pin	Pin assignment
1	V CC485
2	RS 485 B
3	GND 485
4	RS 485 A
5	FE

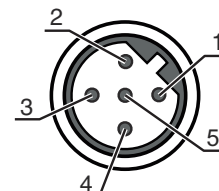

## Diagrams

### Reading field curve - Low Density

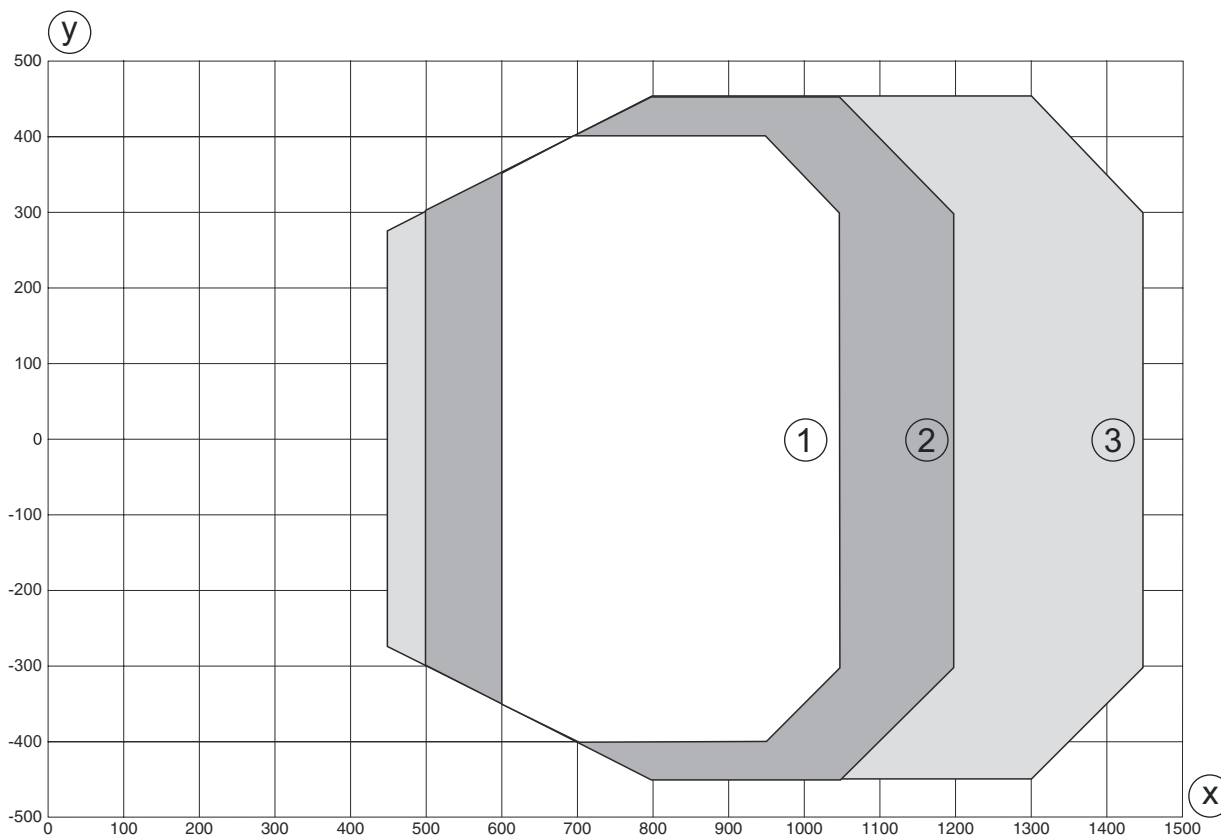

y Reading field width [mm]  
 x Reading field distance [mm]

- 1 Module = 0.3 mm: 600 mm - 1050 mm (450 mm depth of field)
- 2 Module = 0.35 mm: 500 mm - 1200 mm (700 mm depth of field)
- 3 Module = 0.5 mm: 450 mm - 1450 mm (1000 mm depth of field)

# Diagrams

## Reading field curve - Low Density

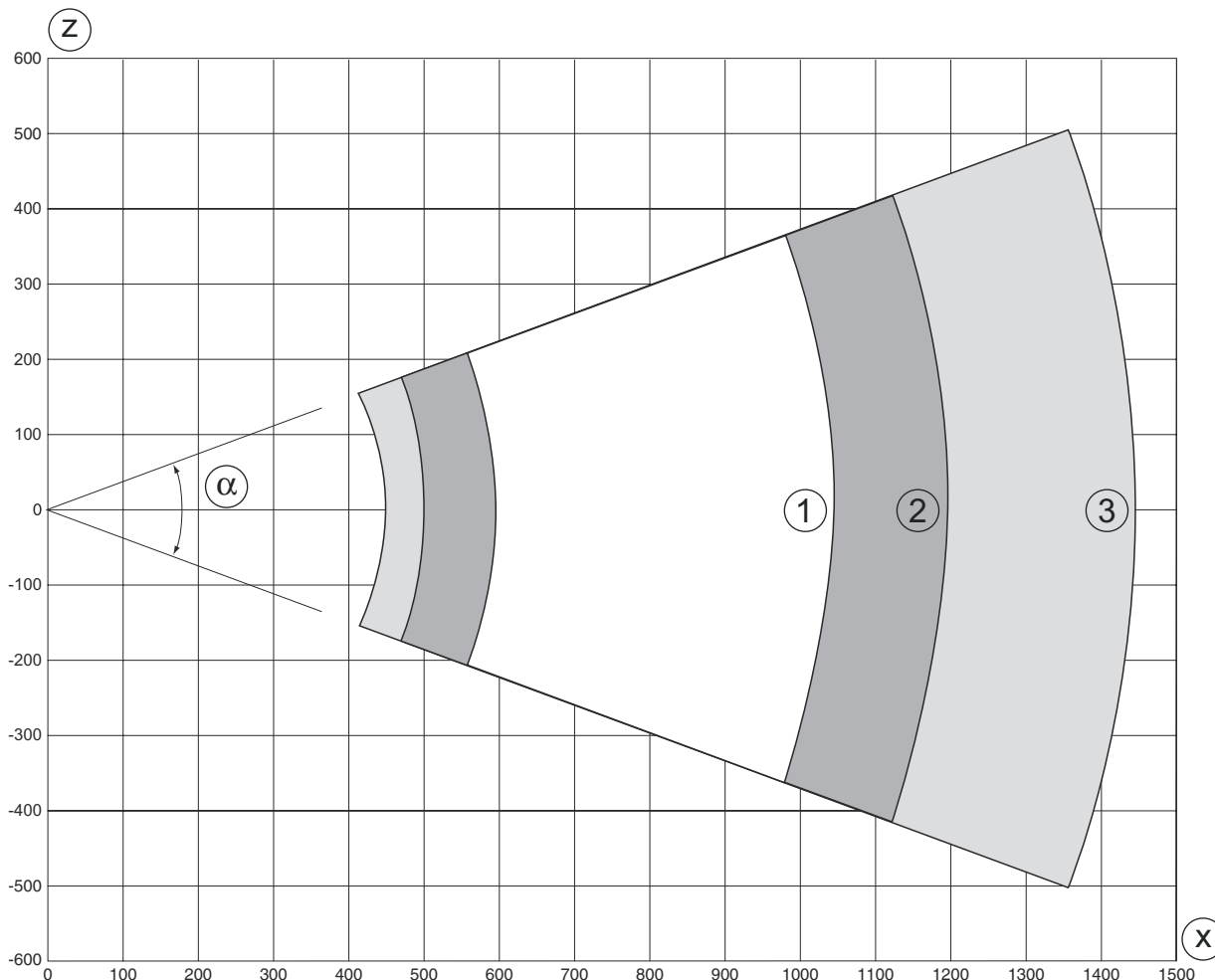

z Reading field height [mm]

x Reading field distance [mm]

- 1 Module = 0.3 mm: 600 mm - 1050 mm (450 mm depth of field)
- 2 Module = 0.35 mm: 500 mm - 1200 mm (700 mm depth of field)
- 3 Module = 0.5 mm: 450 mm - 1450 mm (1000 mm depth of field)

## Operation and display

LED	Display	Meaning
1 PWR	Off	No supply voltage
	Green, flashing	Initialization
	Green, continuous light	Device OK
	Orange, flashing	Service operation
	Orange, continuous light	Reset
	Red, flashing	Device OK, warning set
	Red, continuous light	Device error
2 NET	Off	No supply voltage
	Green, flashing	BUS initialization
	Green, continuous light	Bus operation ok
	Orange, flashing	Service mode
	Orange, continuous light	Reset
	Red, flashing	Communication error

# Operation and display

LED	Display	Meaning
2 NET	Red, continuous light	Network error

## Part number code

Part designation: **BCL XXXX YYZ AAA B**

<b>BCL</b>	<b>Operating principle</b> BCL: bar code reader
<b>XXXX</b>	<b>Series/interface (integrated fieldbus technology)</b> 600i: RS 232/RS 422/ RS 485 (multiNet master) 601i: RS 485 (multiNet slave) 604i: PROFIBUS DP 608i: Ethernet 648i: PROFINET 658i: EtherNet/IP
<b>YY</b>	<b>Scanning principle</b> S: line scanner (single line) O: oscillating-mirror scanner (oscillating mirror)
<b>Z</b>	<b>Optics</b> N: High Density (close) M: Medium Density (medium distance) F: Low Density (remote) L: Long Range (very large distances)
<b>AAA</b>	<b>Beam exit</b> 100: lateral 102: front
<b>BB</b>	<b>Special equipment</b> H: with heating

Note	
	↪ A list with all available device types can be found on the Leuze website at <a href="http://www.leuze.com">www.leuze.com</a> .

## Notes

Observe intended use!	
	<ul style="list-style-type: none"> <li>↪ This product is not a safety sensor and is not intended as personnel protection.</li> <li>↪ The product may only be put into operation by competent persons.</li> <li>↪ Only use the product in accordance with its intended use.</li> </ul>

# Notes

**ATTENTION! LASER RADIATION – CLASS 2 LASER PRODUCT**

**Do not stare into beam!**  
 The device satisfies the requirements of IEC/EN 60825-1:2014 safety regulations for a product of **laser class 2** as well as the U.S. 21 CFR 1040.10 regulations with deviations corresponding to Laser Notice No. 56 from May 08, 2019.

- ⌘ Never look directly into the laser beam or in the direction of reflected laser beams! If you look into the beam path over a longer time period, there is a risk of injury to the retina.
- ⌘ Do not point the laser beam of the device at persons!
- ⌘ Interrupt the laser beam using a non-transparent, non-reflective object if the laser beam is accidentally directed towards a person.
- ⌘ When mounting and aligning the device, avoid reflections of the laser beam off reflective surfaces!
- ⌘ CAUTION! The use of operating and adjusting devices other than those specified here or the carrying out of differing procedures may lead to dangerous exposure to radiation!
- ⌘ Observe the applicable statutory and local laser protection regulations.
- ⌘ The device must not be tampered with and must not be changed in any way.  
 There are no user-serviceable parts inside the device.  
 Repairs must only be performed by Leuze electronic GmbH + Co. KG.

**NOTE**

**Affix laser information and warning signs!**  
 Laser information and warning signs are affixed to the device. In addition, self-adhesive laser information and warning signs (stick-on labels) are supplied in several languages.

- ⌘ Affix the laser information sheet to the device in the language appropriate for the place of use. When using the device in the US, use the stick-on label with the "Complies with 21 CFR 1040.10" note.
- ⌘ Affix the laser information and warning signs near the device if no signs are attached to the device (e.g. because the device is too small) or if the attached laser information and warning signs are concealed due to the installation position.
- ⌘ Affix the laser information and warning signs so that they are legible without exposing the reader to the laser radiation of the device or other optical radiation.

## Accessories

### Connection technology - Connection cables

	Part no.	Designation	Article	Description
	50132079	KD U-M12-5A-V1-050	Connection cable	Application: Chemical resistant Connection 1: Connector, M12, Axial, Female, A-coded, 5 -pin Connector, LED: No Connection 2: Open end Shielded: No Cable length: 5,000 mm Sheathing material: PVC

### Connection technology - Interconnection cables

	Part no.	Designation	Article	Description
	50107726	KB USB A - USB A	Interconnection cable	Suitable for interface: USB Connection 1: USB Connection 2: USB Shielded: Yes Cable length: 1,800 mm Sheathing material: PVC

## Accessories

	Part no.	Designation	Article	Description
	50135254	KDS PB-M12-4A-M12-4A-P3-050	Interconnection cable	Application: Oil and lubricant resistant Suitable for interface: PROFIBUS DP Connection 1: Connector, M12, Axial, Female, B-coded, 5 -pin Connection 2: Connector, M12, Axial, Male, B-coded, 4 -pin Shielded: Yes Cable length: 5,000 mm Sheathing material: PUR

## Connection technology - Terminating resistors

	Part no.	Designation	Article	Description
	50038539	TS 02-4-SA	Terminator plug	Suitable for: MultiNet Plus, PROFIBUS DP Function: Bus termination Connection 1: Connector, M12, Axial, Male, B-coded, 4 -pin

## Mounting technology - Other

	Part no.	Designation	Article	Description
	50111224	BT 59	Mounting bracket	Fastening, at system: Groove mounting Mounting bracket, at device: Clampable Material: Metal Shock absorber: No

## Services

	Part no.	Designation	Article	Description
	S981020	CS30-E-212	Hourly rate	Details: Compilation of the application data, selection and suggestion of suitable sensor system, drawing prepared as assembly sketch. Conditions: Completed questionnaire or project specifications with a description of the application have been provided.
	S981014	CS30-S-110	Start-up support	Details: Performed at location of customer's choosing, duration: max. 10 hours. Conditions: Devices and connection cables are already mounted, price not including travel costs and, if applicable, accommodation expenses.
	S981019	CS30-T-110	Product training	Details: Location and content to be agreed upon, duration: max. 10 hours. Conditions: Price not including travel costs and, if applicable, accommodation expenses.

## Accessories

	Part no.	Designation	Article	Description
	S981021	CS30-V-212	Hourly rate	Details: REA evaluation with creation of a test report, evaluation of the code quality. Conditions: Original bar codes to be provided by the client.

Note	
	A list with all available accessories can be found on the Leuze website in the Download tab of the article detailed page.