

Technical data sheet Light curtain receiver

Part no.: 50131814

CML730i-R20-310.A/PN-M12

Contents

- Technical data
- Dimensioned drawings
- Electrical connection
- Operation and display
- Suitable transmitters
- Part number code
- Notes
- Accessories



For illustration purposes only



Technical data

Basic data

Series	730
Operating principle	Throughbeam principle
Device type	Receiver
Contains	2x BT-NC sliding block
Application	Detection of transparent objects Object measurement

Special version

Special version	Crossed-beam scanning Diagonal-beam scanning Parallel-beam scanning
-----------------	---------------------------------------------------------------------------

Optical data

Measurement field length	310 mm
Number of beams	16 Piece(s)
Beam spacing	20 mm

Measurement data

Minimum object diameter	30 mm
-------------------------	-------

Electrical data

Protective circuit	Polarity reversal protection Short circuit protected Transient protection
--------------------	---------------------------------------------------------------------------------

Performance data

Supply voltage U_B	18 ... 30 V, DC
Residual ripple	0 ... 15 %, From U_B
Open-circuit current	0 ... 135 mA, The specified values refer to the entire package consisting of transmitter and receiver.

Inputs/outputs selectable

Output current, max.	100 mA
Input resistance	6,000 Ω
Number of inputs/outputs selectable	2 Piece(s)
Type	Inputs/outputs selectable
Voltage type, outputs	DC
Switching voltage, outputs	Typ. $U_B / 0$ V
Voltage type, inputs	DC
Switching voltage, inputs	high: ≥ 6 V low: ≤ 4 V

Input/output 1

Activation/disable delay	1 ms
--------------------------	------

Time behavior

Readiness delay	1,500 ms
Cycle time	1 ms
Response time per beam	10 μ s

Interface

Type	PROFINET
------	----------

PROFINET

Function	Process
Conformance class	B
Protocol	PROFINET RT
Switch functionality	Integrated
Transmission speed	10 Mbit/s 100 Mbit/s

Service interface

Type	IO-Link
IO-Link	
Function	Configuration via software Service

Connection

Number of connections	3 Piece(s)
Plug outlet	Axial

Connection 1

Function	Configuration interface Connection to transmitter Signal IN Signal OUT Voltage supply
Type of connection	Connector
Thread size	M12
Type	Male
Material	Metal
No. of pins	8 -pin
Encoding	A-coded

Connection 2

Function	BUS IN
Type of connection	Connector
Thread size	M12
Type	Female
Material	Metal
No. of pins	4 -pin
Encoding	D-coded

Connection 3

Function	BUS OUT
Type of connection	Connector
Thread size	M12
Type	Female
Material	Metal
No. of pins	4 -pin
Encoding	D-coded

Mechanical data

Design	Cubic
Dimension (W x H x L)	29 mm x 35.4 mm x 395 mm
Housing material	Metal
Metal housing	Aluminum
Lens cover material	Plastic
Net weight	550 g
Housing color	Silver
Type of fastening	Groove mounting Via optional mounting device

Technical data

Operation and display

Type of display	LED OLED display
Number of LEDs	4 Piece(s)
Type of configuration	Software Teach-in
Operational controls	Membrane keyboard

Environmental data

Ambient temperature, operation	-30 ... 60 °C
Ambient temperature, storage	-40 ... 70 °C

Certifications

Degree of protection	IP 65
Protection class	III
Approvals	c UL US
Standards applied	IEC 60947-5-2

Classification

Customs tariff number	90314990
ECLASS 5.1.4	27270910
ECLASS 8.0	27270910
ECLASS 9.0	27270910
ECLASS 10.0	27270910
ECLASS 11.0	27270910
ECLASS 12.0	27270910
ECLASS 13.0	27270910
ECLASS 14.0	27270910
ECLASS 15.0	27270910
ETIM 5.0	EC002549
ETIM 6.0	EC002549
ETIM 7.0	EC002549
ETIM 8.0	EC002549
ETIM 9.0	EC002549
ETIM 10.0	EC002549

Dimensioned drawings

All dimensions in millimeters

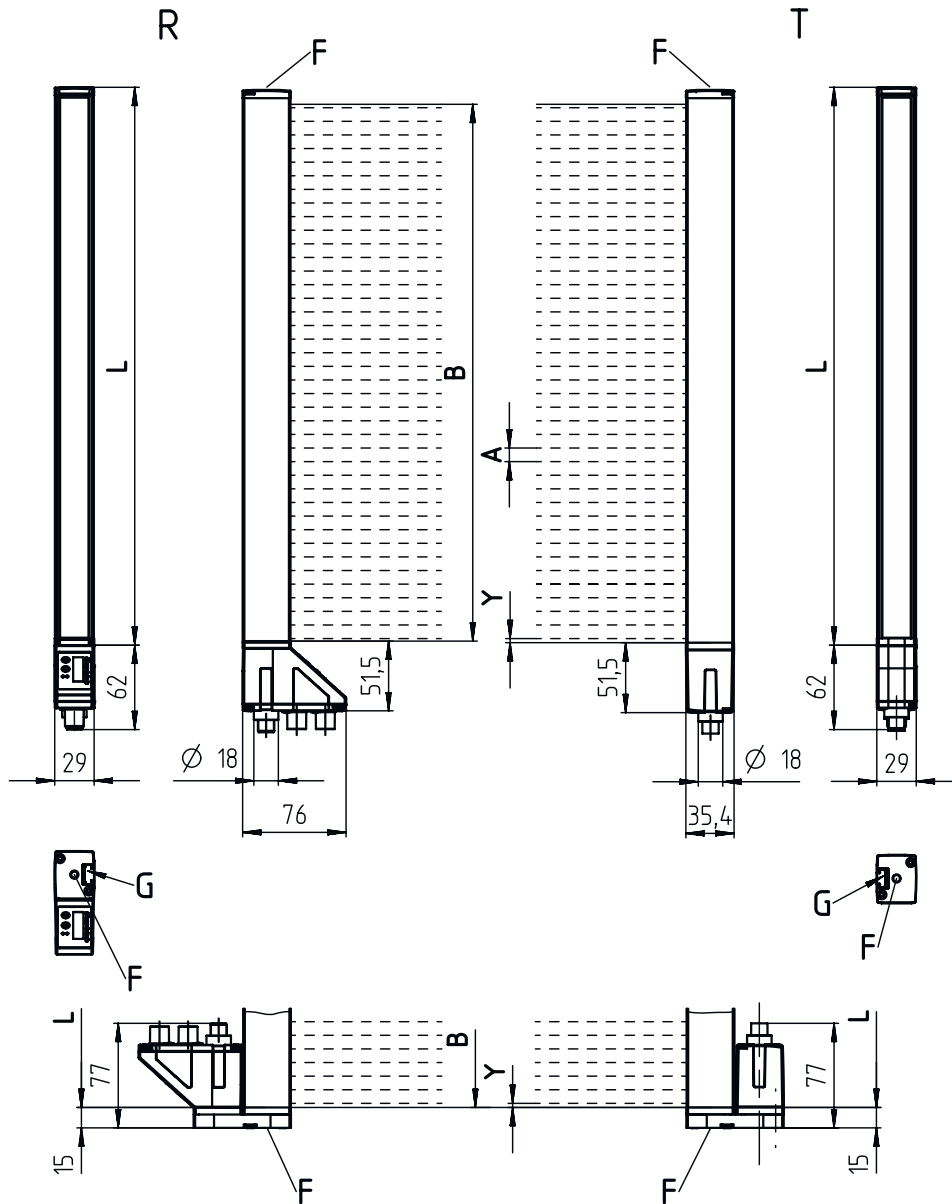

- | | | | |
|---|---------------------------------|---|-----------------------|
| A | Beam spacing 20 mm | L | Profile length 328 mm |
| B | Measurement field length 310 mm | T | Transmitter |
| F | M6 thread | R | Receiver |
| G | Fastening groove | Y | 5 mm |

Dimensioned drawings

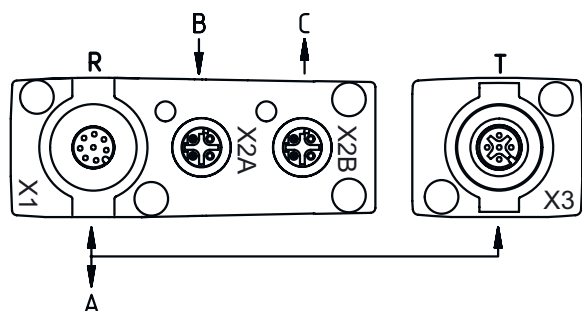

- A PWR / SW IN / OUT
- B BUS IN
- C BUS OUT

Electrical connection

Connection 1

X1

Function	Configuration interface Connection to transmitter Signal IN Signal OUT Voltage supply
Type of connection	Connector
Thread size	M12
Type	Male
Material	Metal
No. of pins	8 -pin
Encoding	A-coded

Pin	Pin assignment
1	V+
2	I/O 1
3	GND
4	IO-Link
5	I/O 2
6	RS 485 Tx+
7	RS 485 Tx+
8	FE/SHIELD

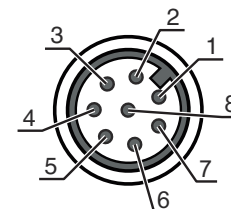

Connection 2

X2A

Function	BUS IN
Type of connection	Connector
Thread size	M12
Type	Female
Material	Metal
No. of pins	4 -pin
Encoding	D-coded

Pin	Pin assignment
1	TD0+
2	RD0+
3	TD0-
4	RD0-

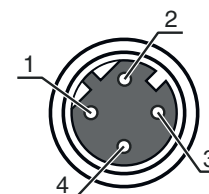

Electrical connection

Connection 3

X2B

Function	BUS OUT
Type of connection	Connector
Thread size	M12
Type	Female
Material	Metal
No. of pins	4 -pin
Encoding	D-coded

Pin Pin assignment

1	TD0+
2	RD0+
3	TD0-
4	RD0-



Operation and display

LED	Display	Meaning
1	Green, continuous light	Operational readiness
	Green, flashing	Teach / error
2	Yellow, continuous light	Light path free, with function reserve
	Yellow, flashing	No function reserve
	Off	Object detected
3	Green, continuous light (at the X2A / X2B connector)	Link
4	Yellow, continuous light (at the X2A / X2B connector)	Activity

Suitable transmitters

	Part no.	Designation	Operating range Operating range limit	Description
	50118630	CML730i-T20-310.A-M12	0.3 ... 9.5 m 0.2 ... 12 m	Operating range: 0.3 ... 9.5 m Connection: Connector, M12, Axial, 5 -pin

Part number code

Part designation: CML7XXi-YYZ-AAAA.BCCDDDD-EEEEFF

CML	Operating principle Measuring light curtain
7XXi	Series 720i: 720i series 730i: 730i series
Y	Device type T: transmitter R: receiver
ZZ	Beam spacing 05: 5 mm 10: 10 mm 20: 20 mm 40: 40 mm
AAAA	Measurement field length [mm], dependent on beam spacing

Part number code

B	Equipment A: Axial connector outlet R: Rear connector outlet
CCC	Interface L: IO-Link /CN: CANopen /PB: PROFIBUS /PN: PROFINET /CV: Analog current and voltage output /D3: RS 485 Modbus
DDD	Special equipment -PS: Power Setting
EEE	Electrical connection M12: M12 connector
FFF	-EX: Explosion protection

Note



A list with all available device types can be found on the Leuze website at www.leuze.com.

Notes



Observe intended use!



- ⌘ This product is not a safety sensor and is not intended as personnel protection.
- ⌘ The product may only be put into operation by competent persons.
- ⌘ Only use the product in accordance with its intended use.

For UL applications:



- ⌘ For UL applications, use is only permitted in Class 2 circuits in accordance with the NEC (National Electric Code).
- ⌘ These proximity switches shall be used with UL Listed Cable assemblies rated 30V, 0.5A min, in the field installation, or equivalent (categories: CYJV/ CYJV7 or PVVA/PVVA7)

Accessories

Connection technology - Connection cables

	Part no.	Designation	Article	Description
	50132079	KD U-M12-5A-V1-050	Connection cable	Application: Chemical resistant Connection 1: Connector, M12, Axial, Female, A-coded, 5 -pin Connector, LED: No Connection 2: Open end Shielded: No Cable length: 5,000 mm Sheathing material: PVC

Accessories

	Part no.	Designation	Article	Description
	50135074	KS ET-M12-4A-P7-050	Connection cable	Application: Oil and lubricant resistant Suitable for interface: Ethernet Connection 1: Connector, M12, Axial, Male, D-coded, 4 -pin Connector, LED: No Connection 2: Open end Shielded: Yes Cable length: 5,000 mm Sheathing material: PUR

Connection technology - Interconnection cables

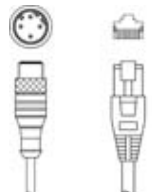
	Part no.	Designation	Article	Description
	50135081	KSS ET-M12-4A-RJ45-A-P7-050	Interconnection cable	Application: Oil and lubricant resistant Suitable for interface: Ethernet Connection 1: Connector, M12, Axial, Male, D-coded, 4 -pin Connection 2: RJ45 Shielded: Yes Cable length: 5,000 mm Sheathing material: PUR

Connection technology - Y distribution cables

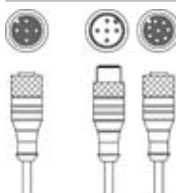
	Part no.	Designation	Article	Description
	50118183	K-Y1 M12A-5m-M12A-S-PUR	Interconnection cable	Connection 1: Connector, M12, Axial, Female, A-coded, 5 -pin Connection 2: Connector, M12, Axial, Male, A-coded, 5 -pin Connection 3: Connector, M12, Axial, Female, A-coded, 8 -pin Shielded: Yes Cable length fork 1: 5,000 mm Cable length fork 2: 150 mm Sheathing material: PUR

Mounting technology - Mounting brackets

	Part no.	Designation	Article	Description
	50142900	BT 700M.5-2SET	Mounting device set	Contains: 2x mounting brackets, 1 teach template, 4 M6 x 10 screws Design of mounting device: Bracket mounting Fastening, at system: Through-hole mounting, T slotted hole Mounting bracket, at device: Screw type, Sliding block Type of mounting device: Rigid Material: Steel

Configuration devices

	Part no.	Designation	Article	Description
	50121098	SET MD12-US2-IL1.1 + Zub.	Diagnostics set	Supply voltage: DC Interface: USB Connections: 2 Piece(s) Degree of protection: IP 20

Accessories

Services

	Part no.	Designation	Article	Description
	S981001	CS10-S-110	Start-up support	Details: Performed at location of customer's choosing, duration: max. 10 hours. Conditions: Devices and connection cables are already mounted, price not including travel costs and, if applicable, accommodation expenses.
	S981005	CS10-T-110	Product training	Details: Location and content to be agreed upon, duration: max. 10 hours. Conditions: Price not including travel costs and, if applicable, accommodation expenses.

Note



A list with all available accessories can be found on the Leuze website in the Download tab of the article detailed page.