

Technical data sheet

Polarized retro-reflective photoelectric sensor

Part no.: 50137345

PRK25C.XA2/4P



For illustration purposes only

Contents

- Technical data
- Dimensioned drawings
- Electrical connection
- Diagrams
- Operation and display
- Reflectors & reflective tapes
- Part number code
- Notes
- Further information
- Accessories



Technical data

Basic data

| | |
|---------------------|---|
| Series | 25C |
| Operating principle | Reflection principle |
| Application | Detection of highly transparent bottles Detection of transparent films |

Special version

| | |
|-----------------|-----------------|
| Special version | Autocollimation |
|-----------------|-----------------|

Optical data

| | |
|--------------------------|---|
| Operating range | 0 ... 5 m, With reflector TK(S) 100x100 |
| Operating range | Guaranteed operating range |
| Operating range limit | 0 ... 6 m, With reflector TK(S) 100x100 |
| Operating range limit | Typical operating range |
| Light source | LED, Red |
| Wavelength | 640 nm |
| Transmitted-signal shape | Pulsed |
| LED group | Exempt group (in acc. with EN 62471) |

Electrical data

| | |
|--------------------|---|
| Protective circuit | Polarity reversal protection Short circuit protected |
|--------------------|---|

Performance data

| | |
|----------------------|--|
| Supply voltage U_B | 10 ... 30 V, DC, Incl. residual ripple |
| Residual ripple | 0 ... 15 %, From U_B |
| Open-circuit current | 0 ... 20 mA |

Outputs

| | |
|-------------------------------------|------------|
| Number of digital switching outputs | 2 Piece(s) |
|-------------------------------------|------------|

Switching outputs

| | |
|-------------------------|---|
| Voltage type | DC |
| Switching current, max. | 100 mA |
| Switching voltage | high: $\geq(U_B - 2.5V)$ low: $\leq 2.5 V$ |

Switching output 1

| | |
|---------------------|-----------------|
| Switching element | Transistor, PNP |
| Switching principle | Light switching |

Switching output 2

| | |
|---------------------|-----------------|
| Switching element | Transistor, PNP |
| Switching principle | Dark switching |

Time behavior

| | |
|---------------------|----------|
| Switching frequency | 1,500 Hz |
| Response time | 0.33 ms |
| Readiness delay | 300 ms |

Connection 1

| | |
|----------------------|------------------------------|
| Function | Signal OUT Voltage supply |
| Type of connection | Cable |
| Cable length | 2,000 mm |
| Sheathing material | PUR |
| Cable color | Black |
| Number of conductors | 4 -wire |
| Wire cross section | 0.2 mm ² |

Mechanical data

| | |
|----------------------------|--|
| Dimension (W x H x L) | 15 mm x 42.7 mm x 30 mm |
| Housing material | Plastic |
| Plastic housing | ABS |
| Lens cover material | Plastic |
| Net weight | 55 g |
| Housing color | Red |
| Type of fastening | Through-hole mounting with M4 thread Via optional mounting device |
| Compatibility of materials | ECOLAB |

Operation and display

| | |
|-------------------------------------|-------------------------|
| Type of display | LED |
| Number of LEDs | 2 Piece(s) |
| Operational controls | Multiturn potentiometer |
| Function of the operational control | Sensitivity adjustment |

Environmental data

| | |
|--------------------------------|---------------|
| Ambient temperature, operation | -40 ... 60 °C |
| Ambient temperature, storage | -40 ... 70 °C |

Certifications

| | |
|----------------------|-----------------|
| Degree of protection | IP 67 IP 69K |
| Protection class | III |
| Approvals | c UL US |
| Standards applied | IEC 60947-5-2 |

Classification

| | |
|-----------------------|----------|
| Customs tariff number | 85365019 |
| ECLASS 5.1.4 | 27270902 |
| ECLASS 8.0 | 27270902 |
| ECLASS 9.0 | 27270902 |
| ECLASS 10.0 | 27270902 |
| ECLASS 11.0 | 27270902 |
| ECLASS 12.0 | 27270902 |
| ECLASS 13.0 | 27270902 |
| ECLASS 14.0 | 27270902 |
| ECLASS 15.0 | 27270902 |
| ETIM 5.0 | EC002717 |
| ETIM 6.0 | EC002717 |
| ETIM 7.0 | EC002717 |
| ETIM 8.0 | EC002717 |
| ETIM 9.0 | EC002717 |
| ETIM 10.0 | EC002717 |

Dimensioned drawings

All dimensions in millimeters

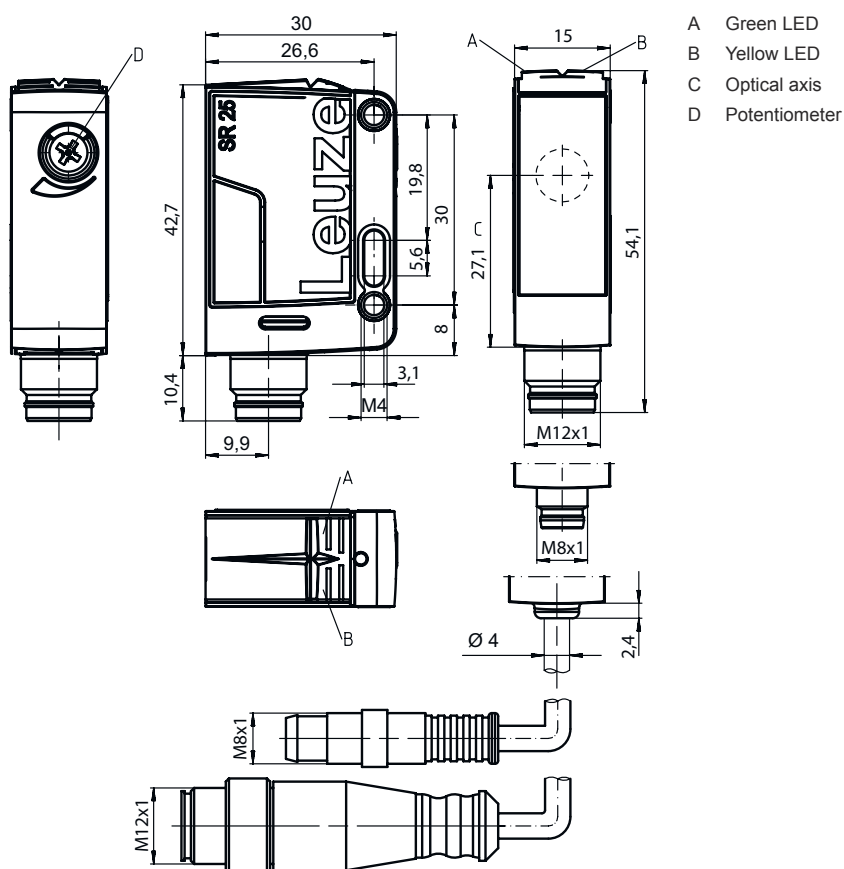

Electrical connection

Connection 1

| | |
|----------------------|---------------------|
| Function | Signal OUT |
| | Voltage supply |
| Type of connection | Cable |
| Cable length | 2,000 mm |
| Sheathing material | PUR |
| Cable color | Black |
| Number of conductors | 4 -wire |
| Wire cross section | 0.2 mm ² |

Conductor color

Conductor assignment

| | |
|-------|-------|
| Brown | V+ |
| White | OUT 2 |
| Blue | GND |
| Black | OUT 1 |

Diagrams

Typ. response behavior (TKS100x100)

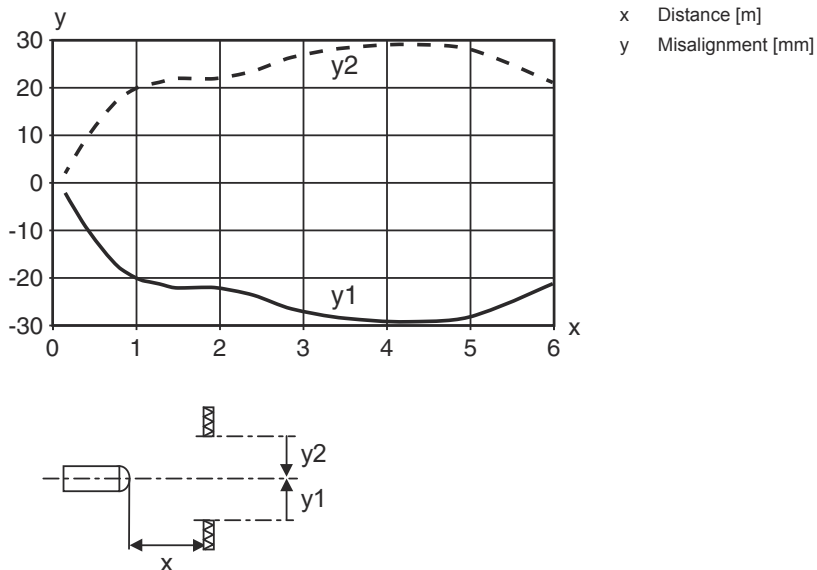

Typ. function reserve

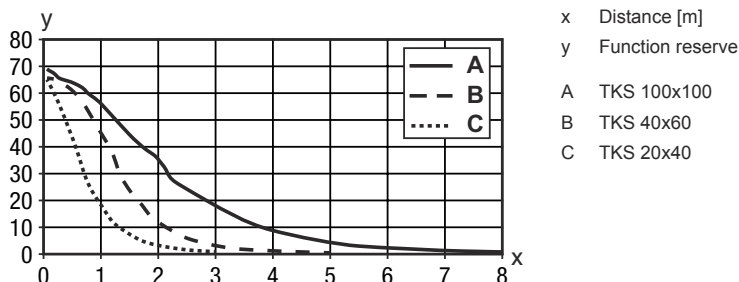



Operation and display

| LED | Display | Meaning |
|-----|--------------------------|-----------------------|
| 1 | Green, continuous light | Operational readiness |
| 2 | Yellow, continuous light | Light path free |

Reflectors & reflective tapes

| | Part no. | Designation | Operating range Operating range limit | Description |
|--|----------|--------------|---|--|
| | 50117583 | MTKS 50x50.1 | 0 ... 3 m 0 ... 3.5 m | Design: Rectangular Triple reflector size: 1.2 mm Reflective surface: 50 mm x 50 mm Material: Plastic Base material: Plastic Chemical designation of the material: PMMA8N Fastening: Through-hole mounting, Adhesive |

Reflectors & reflective tapes

| | Part no. | Designation | Operating range Operating range limit | Description |
|---|----------|-----------------|---|--|
|  | 50106119 | REF 4-A-100x100 | 0 ... 0.9 m 0 ... 1.1 m | Design: Rectangular Reflective surface: 100 mm x 100 mm Material: Plastic Chemical designation of the material: PMMA Fastening: Self-adhesive |
|  | 50110192 | REF 6-A-50x50 | 0 ... 2.2 m 0 ... 2.5 m | Design: Rectangular Triple reflector size: 0.3 mm Reflective surface: 50 mm x 50 mm Material: Plastic Chemical designation of the material: PMMA Fastening: Self-adhesive |
|  | 50003192 | TK 100x100 | 0 ... 5 m 0 ... 6 m | Design: Rectangular Triple reflector size: 4 mm Reflective surface: 96 mm x 96 mm Material: Plastic Base material: Plastic Chemical designation of the material: PMMA8N Fastening: Rear side can be glued |
|  | 50022816 | TKS 100X100 | 0 ... 5 m 0 ... 6 m | Design: Rectangular Triple reflector size: 4 mm Reflective surface: 96 mm x 96 mm Material: Plastic Base material: Plastic Chemical designation of the material: PMMA8N Fastening: Through-hole mounting, Adhesive |
|  | 50081283 | TKS 20X40 | 0 ... 1.7 m 0 ... 2 m | Design: Rectangular Triple reflector size: 2.3 mm Reflective surface: 16 mm x 38 mm Material: Plastic Base material: Plastic Chemical designation of the material: PMMA8N Fastening: Through-hole mounting, Adhesive |
|  | 50040820 | TKS 40X60 | 0 ... 2.5 m 0 ... 3 m | Design: Rectangular Triple reflector size: 4 mm Reflective surface: 37 mm x 56 mm Material: Plastic Base material: Plastic Chemical designation of the material: PMMA8N Fastening: Through-hole mounting, Adhesive |

Part number code

Part designation: AAA25C d EE-f.GGH/IJ-K

| | |
|---------------|--|
| AAA25C | Operating principle / construction HT25C: Diffuse reflection sensor with background suppression PRK25C: Retro-reflective photoelectric sensor with polarization filter LS25C: Throughbeam photoelectric sensor transmitter LE25C: Throughbeam photoelectric sensor receiver DRT25C: Dynamic reference diffuse sensor |
| d | Light type n/a: red light l: infrared light |
| EE | Light source n/a: LED PP: Power PinPoint LED L1: laser class 1 L2: laser class 2 |

Part number code

| | |
|-----------|---|
| f | Preset range (optional) n/a: operating range acc. to data sheet xxxF: Preset range [mm] |
| GG | Equipment A: Autocollimation principle (single lens) S: small light spot D: Detection of stretch-wrapped objects X: extended model HF: Suppression of HF illumination (LED) XL: Extra long light spot T: autocollimation principle (single lens) for highly transparent bottles without tracking TT: autocollimation principle (single lens) for highly transparent bottles with tracking F: Foreground suppression R: greater operating range SL: Slit diaphragm |
| H | Operating range adjustment 1: 270° potentiometer 2: multiturn potentiometer 3: teach-in via button R: greater operating range |
| i | Switching output/function OUT 1/IN: Pin 4 or black conductor 2: NPN transistor output, light switching N: NPN transistor output, dark switching 4: PNP transistor output, light switching P: PNP transistor output, dark switching X: pin not used 8: activation input (activation with high signal) L: IO-Link interface (SIO mode: PNP light switching, NPN dark switching) 6: push-pull switching output, PNP light switching, NPN dark switching G: Push-pull switching output, PNP dark switching, NPN light switching |
| J | Switching output / function OUT 2/IN: pin 2 or white conductor 2: NPN transistor output, light switching N: NPN transistor output, dark switching 4: PNP transistor output, light switching P: PNP transistor output, dark switching W: warning output X: pin not used 6: push-pull switching output, PNP light switching, NPN dark switching T: teach-in via cable G: Push-pull switching output, PNP dark switching, NPN light switching 8: activation input (activation with high signal) |
| K | Electrical connection n/a: cable, standard length 2000 mm, 4-wire 200-M12: cable, length 200 mm with M12 connector, 4-pin, axial (plug) M8: M8 connector, 4-pin (plug) M12: M12 connector, 4-pin (plug) 200-M8: cable, length 200 mm with M8 connector, 4-pin, axial (plug) M8.1: Snap-in, M8 connector, 4-pin (plug) |

Note



A list with all available device types can be found on the Leuze website at www.leuze.com.

Notes



Observe intended use!



- ⌘ This product is not a safety sensor and is not intended as personnel protection.
- ⌘ The product may only be put into operation by competent persons.
- ⌘ Only use the product in accordance with its intended use.

Further information



- Light source: Average life expectancy 100,000 h at an ambient temperature of 25 °C
- Sum of the output currents for both outputs 100 mA
- Use in safety-relevant applications in accordance with EN ISO 13849-1:2015, e.g. muting, protective field switchover of safety laser scanners

Accessories

Mounting technology - Mounting brackets

| | Part no. | Designation | Article | Description |
|---|----------|-------------|------------------|---|
|  | 50118543 | BT 300M.5 | Mounting bracket | Design of mounting device: Angle, L-shape Fastening, at system: Through-hole mounting Mounting bracket, at device: Screw type, Suited for M4 screws Type of mounting device: Adjustable Material: Stainless steel |

Mounting technology - Rod mounts

| | Part no. | Designation | Article | Description |
|---|----------|--------------|-----------------|--|
|  | 50117829 | BTP 200M-D12 | Mounting system | Design of mounting device: Protection hood Fastening, at system: For 12 mm rod Mounting bracket, at device: Screw type Type of mounting device: Clampable, Adjustable, Turning, 360° Material: Metal |
|  | 50117252 | BTU 300M-D12 | Mounting system | Design of mounting device: Mounting system Fastening, at system: For 12 mm rod, Sheet-metal mounting Mounting bracket, at device: Screw type, Suited for M4 screws Type of mounting device: Clampable, Adjustable, Turning, 360° Material: Metal |

Standard reflectors

| | Part no. | Designation | Article | Description |
|---|----------|-------------|-----------|--|
|  | 50109257 | TKS 40x60.1 | Reflector | Design: Rectangular Triple reflector size: 2.3 mm Reflective surface: 37 mm x 56 mm Material: Plastic Base material: Plastic Chemical designation of the material: PMMA8N Fastening: Through-hole mounting, Adhesive |

Accessories

Micro-triad-type reflectors

| | Part no. | Designation | Article | Description |
|---|----------|--------------|-----------|--|
|  | 50117583 | MTKS 50x50.1 | Reflector | Design: Rectangular Triple reflector size: 1.2 mm Reflective surface: 50 mm x 50 mm Material: Plastic Base material: Plastic Chemical designation of the material: PMMA8N Fastening: Through-hole mounting, Adhesive |

Note



A list with all available accessories can be found on the Leuze website in the Download tab of the article detailed page.