

Technical data sheet

Ultrasonic fork sensor

Part no.: 50142873
IGSU14E/1WT.3-M12V



For illustration purposes only

Contents

- Technical data
- Dimensioned drawings
- Electrical connection
- Diagrams
- Operation and display
- Part number code
- Notes
- Further information
- Accessories



Technical data

Basic data

Series	14
Principle of physics	Ultrasonics
Application	Detection of non-transparent labels Detection of transparent labels
Label width, min.	4 mm
Label gap, min.	2 mm
Medium	Transparent and not transparent

Special version

Special version	ALC function (tracking) easyTeach function Manual fine tuning of the switching threshold Teach input Warning output
-----------------	---

Electrical data

Protective circuit	Polarity reversal protection Short circuit protected
--------------------	---

Performance data

Supply voltage U_B	18 ... 30 V, DC
Residual ripple	0 ... 10 %, From U_B
Open-circuit current	0 ... 60 mA, Typical value

Inputs

Number of teach inputs	1 Piece(s)
------------------------	------------

Teach inputs

Type	Teach input
Voltage type	DC
Switching voltage	high: $\geq 9V$ low: $\leq 2 V$
Input resistance	15,000 Ω

Teach input 1

Active switching state	High
------------------------	------

Outputs

Number of digital switching outputs	2 Piece(s)
-------------------------------------	------------

Switching outputs

Type	Digital switching output
Voltage type	DC
Switching current, max.	100 mA
Switching voltage	high: $\geq (U_B - 2V)$ low: $\leq 2 V$
Load capacity	0.01 μF

Switching output 1

Switching element	Transistor, Push-pull
Switching principle	IO-Link / NPN light switching (switching in the gap), PNP dark switching (switching on the label)

Switching output 2

Switching element	Transistor, Push-pull
Switching principle	active low (normal operation high, event case low)

Time behavior

Switching frequency	2,000 Hz
Response time	0.2 ms
Readiness delay	300 ms
Max. conveyor speed during teach-in	50 m/min

Interface

Type	IO-Link
------	---------

IO-Link

COM mode	COM3
Profile	Smart sensor profile
Min. cycle time	COM3 = 0.5 ms
Frame type	2.5
Specification	V1.1
Device ID	2511
SIO-mode support	Yes

Connection

Number of connections	1 Piece(s)
-----------------------	------------

Connection 1

Function	Signal IN Signal OUT Voltage supply
Type of connection	Connector
Thread size	M12
Type	Male
Material	Metal
No. of pins	5 -pin
Encoding	A-coded
Plug outlet	Vertical (perpendicular to belt movement)

Mechanical data

Design	Fork
Mouth width	4 mm
Mouth depth	80 mm
Dimension (W x H x L)	22 mm x 46.9 mm x 96 mm
Housing material	Metal
Metal housing	Diecast zinc, galvanic nickel coating
Net weight	270 g
Housing color	Silver
Type of fastening	Mounting thread Through-hole mounting

Operation and display

Type of display	LED
Number of LEDs	4 Piece(s)
Operational controls	Control buttons
Function of the operational control	Dynamic teach on label carrier and label

Environmental data

Ambient temperature, operation	0 ... 60 °C
Ambient temperature, storage	-40 ... 70 °C

Technical data

Certifications

Degree of protection	IP 65
Protection class	III
Approvals	c UL US
Standards applied	EN 60947-5-2:2007+A1:2012
US patents	US 6,314,054 B

Classification

Customs tariff number	85365019
ECLASS 5.1.4	27272801
ECLASS 8.0	27272801
ECLASS 9.0	27272801
ECLASS 10.0	27272801
ECLASS 11.0	27272801
ECLASS 12.0	27272801
ECLASS 13.0	27272801
ECLASS 14.0	27272801
ECLASS 15.0	27272801
ECLASS 16.0	27272801
ETIM 5.0	EC001847
ETIM 6.0	EC001847
ETIM 7.0	EC001847
ETIM 8.0	EC001847
ETIM 9.0	EC001847
ETIM 10.0	EC001847
UNSPSC 26.08	41111960

Dimensioned drawings

All dimensions in millimeters

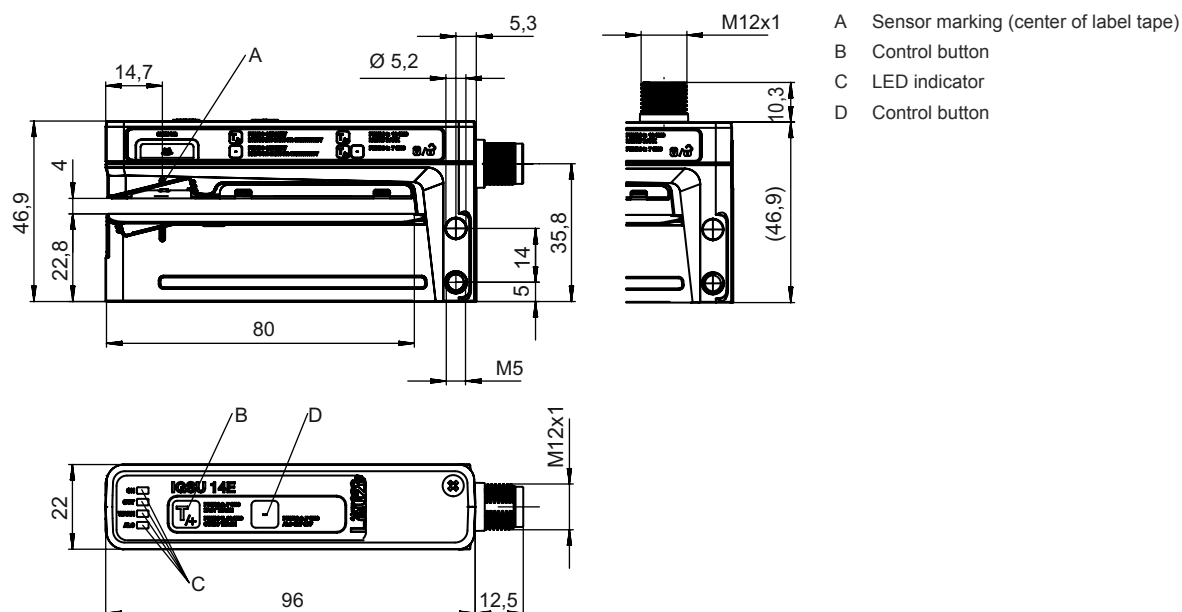

Electrical connection

Connection 1

Function	Signal IN
	Signal OUT
	Voltage supply
Type of connection	Connector
Thread size	M12
Type	Male
Material	Metal
No. of pins	5 -pin
Encoding	A-coded
Plug outlet	Vertical (perpendicular to belt movement)

Pin	Pin assignment
1	V+
2	OUT WARN
3	GND
4	IO-Link / OUT 1
5	Teach-in

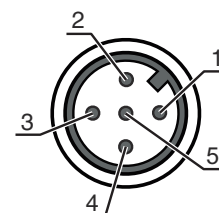

Diagrams

Repeatability as a function of the conveyor speed

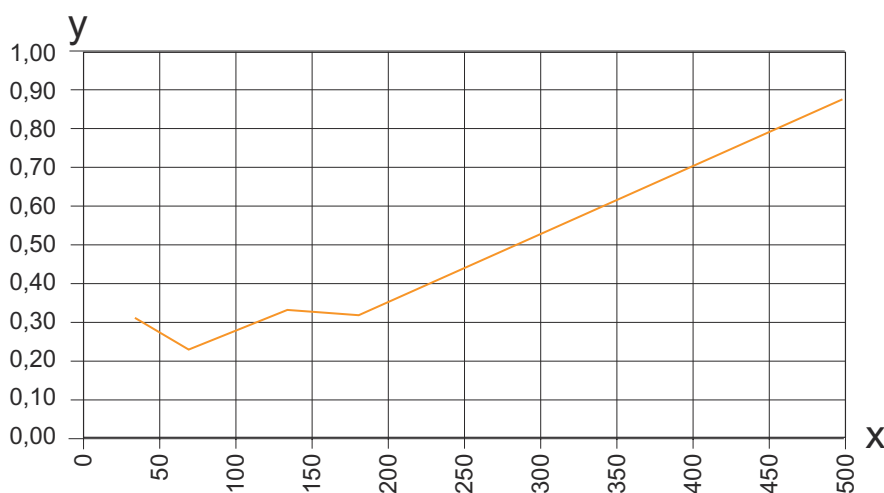

x Conveyor speed [m/min]
 y Repeatability [mm]

NOTE Example process of a paper-label-on-paper-carrier combination (label length = 89.7 mm, label gap = 2 mm)

Operation and display

LED	Display	Meaning
1 ON	Green, continuous light	Operational readiness
2 OUT	Yellow, continuous light	Switching signal in the label gap
3 WARN	Red, continuous light	Teach error
4 ALC	Yellow, continuous light	Tracking function active

Part number code

Part designation: AAA14E/BCD.EEE-FFF

AAA14E	Operating principle / construction GSU14E: Ultrasonic fork sensor IGSU14E: Ultrasonic fork sensor with integrated easyTeach function GSX14E: Fork sensor, ultrasonic/optical combination
B	Switching output / function OUT 1/IN: Pin 4 6: push-pull switching output, PNP light switching (switching in the gap), NPN dark switching (switching on the label) G: Push-pull switching output, PNP dark switching (switching on the label), NPN light switching (switching in the gap) 1: IO-Link / NPN light switching (switching in the gap), PNP dark switching (switching on the label) L: IO-Link / PNP light switching (switching in the gap), NPN dark switching (switching on the label)
C	Switching output / function OUT 2/IN: pin 2 6: push-pull switching output, PNP light switching (switching in the gap), NPN dark switching (switching on the label) G: Push-pull switching output, PNP dark switching (switching on the label), NPN light switching (switching in the gap) W: warning output
D	Switching output / function OUT 3/IN: Pin 5 T: teach-in
EEE	Equipment 3: teach-in via button SD: Splice inspection
FFF	Electrical connection M12: M12 connector, 5-pin (horizontal plug outlet) M12V: M12 connector, 5-pin (vertical plug outlet)

Note



A list with all available device types can be found on the Leuze website at www.leuze.com.

Notes



Observe intended use!



- ⌘ This product is not a safety sensor and is not intended as personnel protection.
- ⌘ The product may only be put into operation by competent persons.
- ⌘ Only use the product in accordance with its intended use.



For UL applications:



- ⌘ For UL applications, use is only permitted in Class 2 circuits in accordance with the NEC (National Electric Code).

Further information

- The push-pull switching outputs must not be connected in parallel.
- The label material used determines the achievable precision and the reliability of gap detection between labels.
- To achieve high repeatability, the label tape must be slightly under tension on the lower fork.

Accessories



Connection technology - Connection unit

	Part no.	Designation	Article	Description
	50144900	MD 798i-11-82/L5-2222	IO-Link master	Current consumption, max.: 11,000 mA Interface: IO-Link, Automatic protocol detection, EtherNet IP, Modbus TCP, PROFINET Connections: 12 Piece(s) Sensor connections: 8 Piece(s) Degree of protection: IP 67, IP 65, IP 69K

Connection technology - Connection cables

	Part no.	Designation	Article	Description
	50132079	KD U-M12-5A-V1-050	Connection cable	Application: Chemical resistant Connection 1: Connector, M12, Axial, Female, A-coded, 5 -pin Connector, LED: No Connection 2: Open end Shielded: No Cable length: 5,000 mm Sheathing material: PVC

General

	Part no.	Designation	Article	Description
	50144288	FS 14EML.5	Carriage	Housing material: Stainless steel, V2A
	50144289	FS 14EML1.5	Carriage	Housing material: Stainless steel, V2A

Note



A list with all available accessories can be found on the Leuze website in the Download tab of the article detailed page.