

## Technical data sheet

### Safety light curtain receiver

Part no.: 68017404  
MLC510R40-450H/A



#### Contents

- Technical data
- Dimensioned drawings
- Electrical connection
- Operation and display
- Suitable transmitters
- Part number code
- Notes
- Accessories



## Technical data

### Basic data

Series	MLC 500
Device type	Receiver
Cascading	Host
Contains	2x BT-NC sliding block
Application	Access guarding Danger zone guarding Hand protection

### Characteristic parameters

Type	4, IEC/EN 61496
SIL	3, IEC 61508
SILCL	3, IEC/EN 62061
Performance Level (PL)	e, EN ISO 13849-1
PFH <sub>D</sub>	7.73E-09 per hour
Mission time T <sub>M</sub>	20 years, EN ISO 13849-1
Category	4, EN ISO 13849

### Protective field data

Resolution	40 mm
Protective field height	450 mm

### Optical data

Number of beams	18 Piece(s)
Synchronization	Optical between transmitter and receiver

### Electrical data

Protective circuit	Overvoltage protection Short circuit protected
<b>Performance data</b>	
Supply voltage U <sub>B</sub>	26.5 ... 31.6 V
Current consumption from AS-i circuit	150 mA

### Time behavior

Response time	5 ms, plus response times of the Middle Guest/Guest devices
Restart delay time	100 ms

### Interface

Type	AS-Interface Safety at Work
<b>AS-i</b>	
Function	Process
AS-i profile	S-0.B.F
Slave address	1..31 programmable, default=0
Cycle time acc. to AS-i specifications	Max. 5 ms

### Connection

Number of connections	2 Piece(s)
<b>Connection 1</b>	
Function	Machine interface
Type of connection	Connector
Thread size	M12
Material	Metal
No. of pins	5 -pin

### Connection 2

Function	Cascade, Guest Out Cascade, Middle Guest Out
Type of connection	Cable with connector
Cable length	330 mm
Sheathing material	PUR
Thread size	M12
Material	Plastic
No. of pins	8 -pin

### Cable properties

Permissible conductor cross section, type.	0.25 mm <sup>2</sup>
Length of connection cable, max.	100 m
Permissible cable resistance to load, max.	200 Ω

### Mechanical data

Dimension (W x H x L)	29 mm x 516 mm x 53 mm
Housing material	Metal
Metal housing	Aluminum
Lens cover material	Plastic / PMMA
Material of end caps	Diecast zinc
Net weight	675 g
Housing color	Yellow, RAL 1021
Type of fastening	Groove mounting Mounting brackets Swivel mount

### Operation and display

Type of display	LED
Number of LEDs	2 Piece(s)

### Environmental data

Ambient temperature, operation	0 ... 55 °C
Ambient temperature, storage	-30 ... 70 °C
Relative humidity (non-condensing)	0 ... 95 %

### Certifications

Degree of protection	IP 65
Protection class	III
Approvals	c TÜV NRTL US c UL US TÜV Süd
Vibration resistance	50 m/s <sup>2</sup>
Shock resistance	100 m/s <sup>2</sup>
US patents	US 6,418,546 B

## Technical data

Customs tariff number	85365019
ECLASS 5.1.4	27272704
ECLASS 8.0	27272704
ECLASS 9.0	27272704
ECLASS 10.0	27272704
ECLASS 11.0	27272704
ECLASS 12.0	27272704
ECLASS 13.0	27272704
ECLASS 14.0	27272704
ECLASS 15.0	27272704
ETIM 5.0	EC002549
ETIM 6.0	EC002549
ETIM 7.0	EC002549
ETIM 8.0	EC002549
ETIM 9.0	EC002549
ETIM 10.0	EC002549

## Dimensioned drawings

All dimensions in millimeters

Calculation of the effective protective field height  $H_{PFE} = H_{PFN} + B + C$

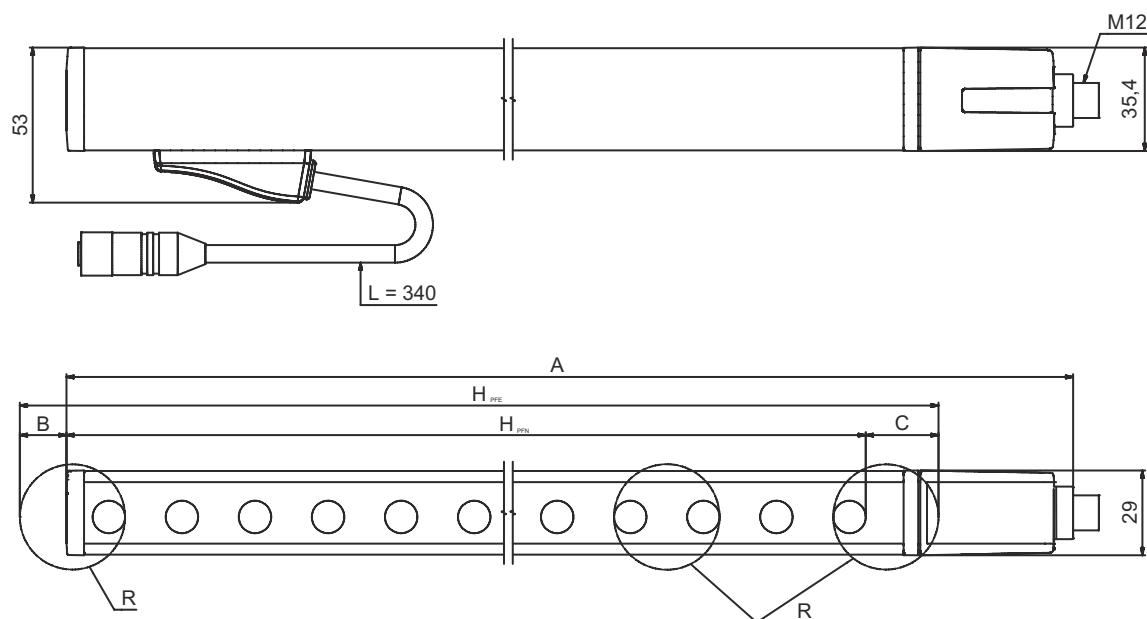

$H_{PFE}$  Effective protective field height = 490 mm

$H_{PFN}$  Nominal protective field height = 450 mm

A Total height = 516 mm

B 25 mm

C 15 mm

R Effective protective field height  $H_{PFE}$  goes beyond the dimensions of the optics area to the outer borders of the circles labeled with R.

# Electrical connection

## Connection 1

Function	Machine interface
Type of connection	Connector
Thread size	M12
Type	Male
Material	Metal
No. of pins	5 -pin
Encoding	A-coded

Pin	Pin assignment
1	AS-i+
2	n.c.
3	AS-i-
4	n.c.
5	n.c.

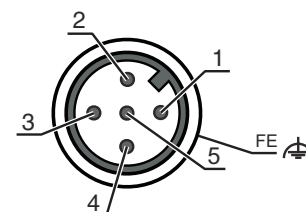

## Connection 2

Function	Cascade, Guest Out Cascade, Middle Guest Out
Type of connection	Cable with connector
Cable length	330 mm
Sheathing material	PUR
Cable color	Black
Wire cross section	0.14 mm <sup>2</sup>
Type of stranding	Pair stranding (twisted pair)
Thread size	M12
Type	Female
Material	Plastic
No. of pins	8 -pin
Encoding	A-coded

# Operation and display

LED	Display	Meaning
1	Off	Device switched off
	Red, continuous light	Protective field interrupted
	Red, flashing, 1 Hz	External error
	Red, flashing, 10 Hz	Internal error
	Green, flashing, 1 Hz	Protective field free, weak signal
	Green, continuous light	Protective field free
2	Off	No voltage
	On	OSSD off, transmission channel C2
	Green, continuous light	AS-i slave communicating with AS-i master
	Red, continuous light	AS-i slave not communicating with AS-i master
	Yellow, flashing	AS-i slave has invalid address 0
	Red, flashing	AS-i slave device error or AS-i connection defective
	Red/green, flashing alternately	Periphery error

## Suitable transmitters

	Part no.	Designation	Article	Description
	68016404	MLC500T40-450H/A	Safety light curtain transmitter	Resolution: 40 mm Protective field height: 450 mm Operating range: 0 ... 20 m Interface: AS-Interface Safety at Work Connection: Connector, M12, Metal, 5 -pin

## Part number code



Part designation: MLCxyy-za-hhhh-e-i-ooo

<b>MLC</b>	<b>Safety light curtain</b>
<b>x</b>	<b>Series</b> 3: MLC 300 5: MLC 500
<b>yy</b>	<b>Function classes</b> 00: transmitter 01: transmitter (AIDA) 02: transmitter with test input 10: basic receiver - automatic restart 11: basic receiver - automatic restart (AIDA) 20: standard receiver - EDM/RES selectable 30: Extended receiver blanking/muting or gating 35: Extended receiver – Gating
<b>z</b>	<b>Device type</b> T: transmitter R: receiver
<b>a</b>	<b>Resolution</b> 14: 14 mm 20: 20 mm 30: 30 mm 40: 40 mm 90: 90 mm
<b>hhhh</b>	<b>Protective field height</b> 150 ... 3000: from 150 mm to 3000 mm
<b>e</b>	<b>Host/Guest (optional)</b> H: Host MG: Middle Guest G: Guest
<b>i</b>	<b>Interface (optional)</b> /A: AS-i
<b>ooo</b>	<b>Option</b> /V: high Vibration-proof EX2: explosion protection (zones 2 + 22) SPG: Smart Process Gating SPG RR: Smart Process Gating – Reduced resolution

### Note

	A list with all available device types can be found on the Leuze website at <a href="http://www.leuze.com">www.leuze.com</a> .
--	--

## Notes

 <b>Observe intended use!</b>	
	<ul style="list-style-type: none"> <li>The product may only be put into operation by competent persons.</li> <li>Only use the product in accordance with its intended use.</li> </ul>

## Accessories

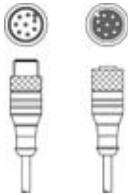

### Connection technology - Interconnection cables

	Part no.	Designation	Article	Description
	429278	CB-M12-2000E-8TP	Interconnection cable	Connection 1: Connector, M12, Axial, Female, A-coded, 8 -pin Connection 2: Connector, M12, Axial, Male, A-coded, 8 -pin Shielded: Yes Cable length: 2,000 mm Sheathing material: PUR

### Mounting technology - Swivel mounts

	Part no.	Designation	Article	Description
	429393	BT-2HF	Mounting bracket set	Fastening, at system: Through-hole mounting Mounting bracket, at device: Clampable Type of mounting device: Turning, 360° Material: Metal, Plastic

### Services

	Part no.	Designation	Article	Description
	S981050	CS40-I-140	Safety inspection	Details: Checking of a safety light barrier application in accordance with current standards and guidelines. Inclusion of the device and machine data in a database, production of a test log per application. Conditions: It must be possible to stop the machine, support provided by customer's employees and access to the machine for Leuze employees must be ensured.
	S981046	CS40-S-140	Start-up support	Details: For safety devices including stopping time measurement and initial inspection. Conditions: Devices and connection cables are already mounted, price not including travel costs and, if applicable, accommodation expenses.

#### Note



A list with all available accessories can be found on the Leuze website in the Download tab of the article detailed page.