

## Technical data sheet Optical positioning sensor

Part no.: 50144688

AMS 107i 40 BTA



For illustration purposes only

### Contents

- Technical data
- Dimensioned drawings
- Electrical connection
- Diagrams
- Operation and display
- Part number code
- Notes
- Further information
- Accessories



CDRH



## Technical data

### Basic data

Series	AMS 100i
Application	Collision protection of cranes / gantry cranes Positioning of electroplating plants Positioning of skillet systems and side-tracking skates Positioning of stacker cranes

### Characteristic parameters

MTTF	27 years
------	----------

### Optical data

Light source	Laser, Red
Wavelength	660 nm
Laser class	2, IEC/EN 60825-1:2014
Max. laser power	0.004 W
Transmitted-signal shape	Modulated
Pulse duration	0.8 µs
Light spot size [at sensor distance]	40 mm [40,000 mm]
Type of light spot geometry	Round

### Measurement data

Measurement range	100 ... 40,000 mm
Resolution	0.001 ... 10 mm
Accuracy	2 mm, +/-
Reproducibility (3 sigma), short range	0.9 mm (with measurement range up to 500 mm)
Reproducibility (3 sigma), distant range	0.6 mm (with measurement range from 500 mm)
Measurement value output	1.7 ms
Temperature drift, absolute (mm/10K)	≤ 1 mm/10K
Max. traverse rate	10 m/s

### Electrical data

Protective circuit	No information
<b>Performance data</b>	
Supply voltage $U_B$	18 ... 30 V, DC
Current consumption, max.	250 mA

### Time behavior

Response time	14 ms, Basis for contouring error calculation = 7 ms
---------------	--

### Interface

Type	SSI
<b>SSI</b>	
Clock frequency	50 ... 800 kHz

### Connection

Number of connections	3 Piece(s)
-----------------------	------------

### Connection 1

Function	Signal IN Signal OUT Voltage supply
Type of connection	Connector
Designation on device	PWR
Thread size	M12
Type	Male
Material	Metal
No. of pins	5 -pin
Encoding	A-coded

### Connection 2

Function	Data interface
Type of connection	Connector
Designation on device	X1 SSI
Thread size	M12
Type	Male
No. of pins	5 -pin
Encoding	B-coded

### Connection 3

Function	Service interface
Type of connection	Connector
Designation on device	XF0 SERVICE
Thread size	M12
Type	Female
No. of pins	4 -pin
Encoding	D-coded

### Mechanical data

Design	Cubic
Dimension (W x H x L)	70 mm x 139 mm x 118 mm
Housing material	Metal
Metal housing	Diecast aluminum
Lens cover material	Glass
Net weight	1,100 g
Housing color	Gray Red
Type of fastening	Through-hole mounting

### Operation and display

Type of display	LC Display LED
Number of LEDs	2 Piece(s)
Operational controls	Membrane keyboard

### Environmental data

Ambient temperature, operation	-5 ... 60 °C
Ambient temperature, storage	-30 ... 70 °C
Relative humidity (non-condensing)	90 %

### Certifications

Degree of protection	IP 65
Protection class	III
Approvals	UL

## Technical data

Customs tariff number	90314990
ECLASS 5.1.4	27270801
ECLASS 8.0	27270801
ECLASS 9.0	27270801
ECLASS 10.0	27270801
ECLASS 11.0	27270801
ECLASS 12.0	27270916
ECLASS 13.0	27270916
ECLASS 14.0	27270916
ECLASS 15.0	27270916
ECLASS 16.0	27270916
ETIM 5.0	EC001825
ETIM 6.0	EC001825
ETIM 7.0	EC001825
ETIM 8.0	EC001825
ETIM 9.0	EC001825
ETIM 10.0	EC001825
UNSPSC 26.08	39121528

## Dimensioned drawings

All dimensions in millimeters

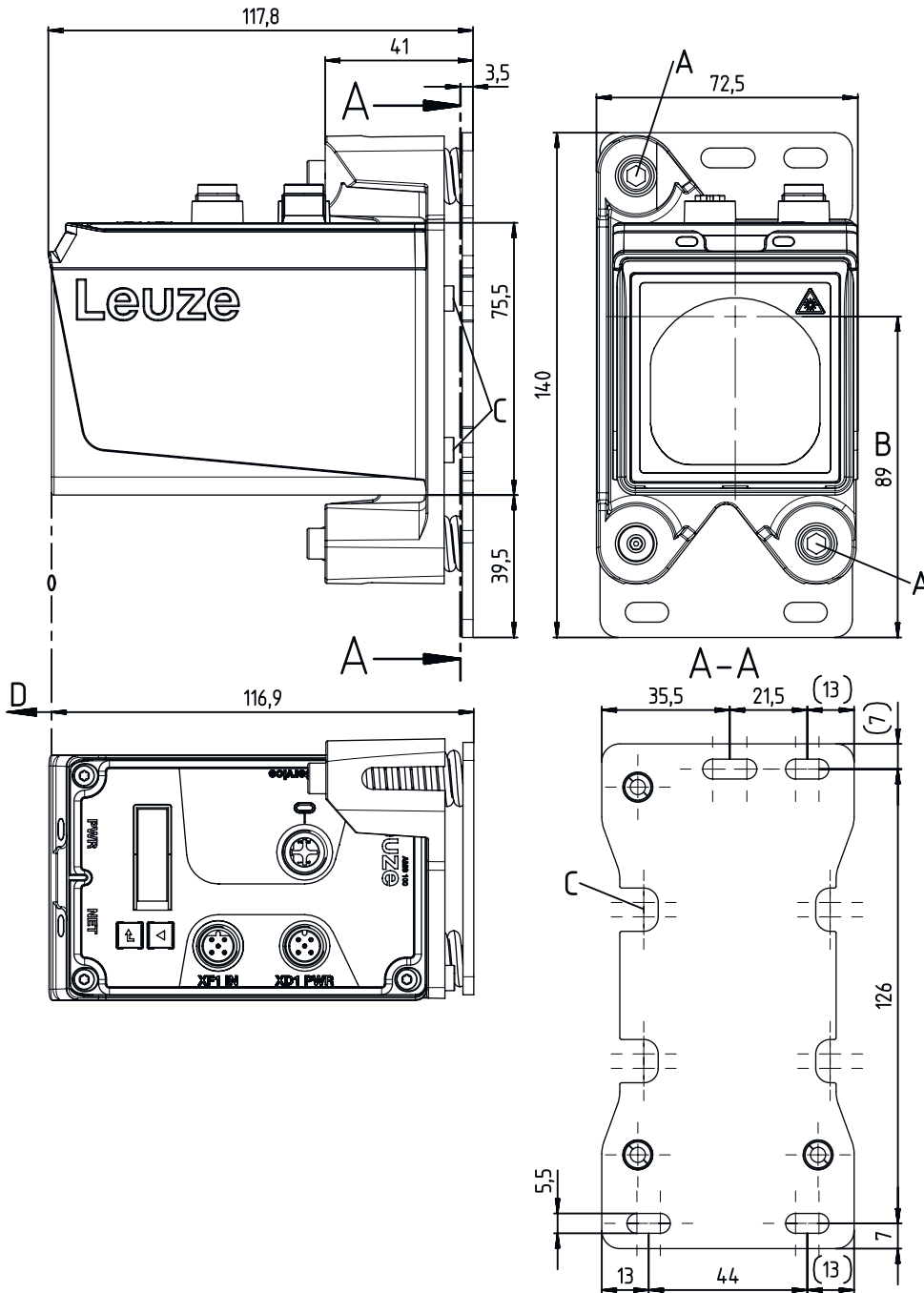

- A Adjustment screws with hexagon socket WAF4
- B Optical axis

- C Mounting option for alignment device "BTA"
- D Zero point of the distance to be measured

## Electrical connection

### Connection 1

### PWR

Function	Signal IN Signal OUT Voltage supply
Type of connection	Connector
Thread size	M12
Type	Male
Material	Metal
No. of pins	5 -pin
Encoding	A-coded

Pin	Pin assignment
-----	----------------

1	V+
2	I/O 1
3	GND
4	I/O 2
5	FE



### Connection 2

### X1 SSI

Function	Data interface
Type of connection	Connector
Thread size	M12
Type	Male
Material	Metal
No. of pins	5 -pin
Encoding	B-coded

Pin	Pin assignment
-----	----------------

1	DATA+
2	DATA-
3	CLK+
4	CLK-
5	FE



### Connection 3

### XF0 SERVICE

Function	Service interface
Type of connection	Connector
Thread size	M12
Type	Female
Material	Metal
No. of pins	4 -pin
Encoding	D-coded

Pin	Pin assignment
-----	----------------

1	TD+
2	RD+
3	TD-
4	RD-



# Diagrams

## Typ. reproducibility

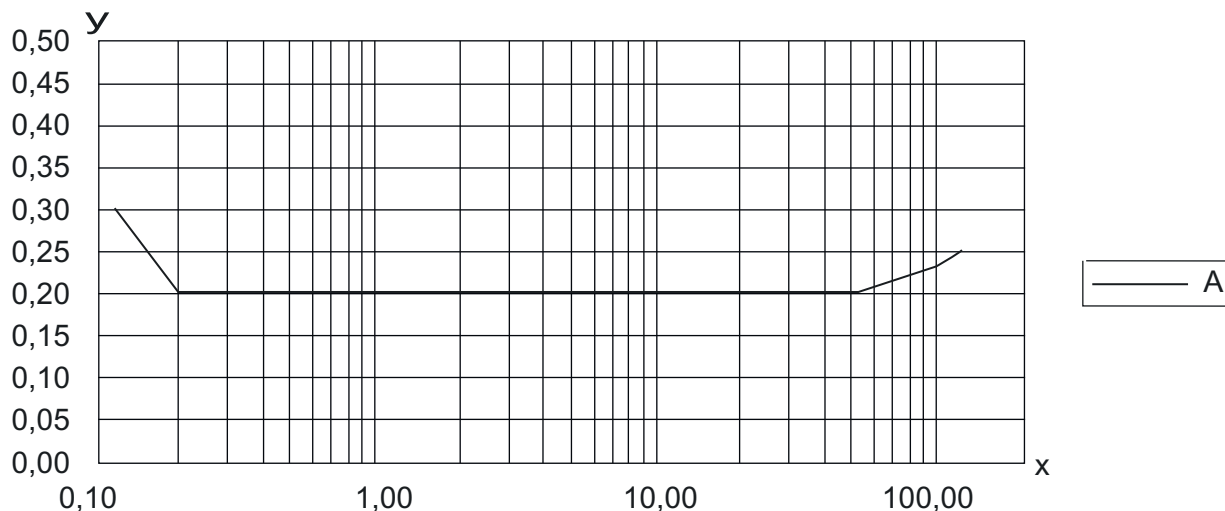

X Reproducibility [mm]

Y Distance [m]

A 1 sigma (max) / mm

## Operation and display

LED	Display	Meaning
1 PWR	Off	No supply voltage
	Green, flashing	Voltage connected / no measurement value output / initialization running
	Green, continuous light	Device OK, measurement value output
	Red, flashing	Device OK, warning set
	Red, continuous light	No measurement value output
	Orange, continuous light	No data transmission
2 BUS	Off	No supply voltage
	Green, continuous light	Data transmission active
	Green, flashing	Device ok, initialization phase

## Part number code

Part designation: **AMS 1XXi YYY Z AAA**

AMS	<b>Series</b> AMS: absolute measurement system
1XXi	<b>Interface</b> 107i:
YYY	<b>Operating range</b> 120: max. operating range in m
AAA	<b>Special equipment</b> BTA: adjustable mounting device

### Note



A list with all available device types can be found on the Leuze website at [www.leuze.com](http://www.leuze.com).

## Notes

### Observe intended use!



- ☞ This product is not a safety sensor and is not intended as personnel protection.
- ☞ The product may only be put into operation by competent persons.
- ☞ Only use the product in accordance with its intended use.

### ATTENTION! LASER RADIATION – CLASS 2 LASER PRODUCT



#### Do not stare into beam!

The device satisfies the requirements of IEC/EN 60825-1:2014 safety regulations for a product of **laser class 2** as well as the U.S. 21 CFR 1040.10 regulations with deviations corresponding to Laser Notice No. 56 from May 08, 2019.

- ☞ Never look directly into the laser beam or in the direction of reflected laser beams! If you look into the beam path over a longer time period, there is a risk of injury to the retina.
- ☞ Do not point the laser beam of the device at persons!
- ☞ Interrupt the laser beam using a non-transparent, non-reflective object if the laser beam is accidentally directed towards a person.
- ☞ When mounting and aligning the device, avoid reflections of the laser beam off reflective surfaces!
- ☞ CAUTION! The use of operating and adjusting devices other than those specified here or the carrying out of differing procedures may lead to dangerous exposure to radiation!
- ☞ Observe the applicable statutory and local laser protection regulations.
- ☞ The device must not be tampered with and must not be changed in any way.  
There are no user-serviceable parts inside the device.  
Repairs must only be performed by Leuze electronic GmbH + Co. KG.

### NOTE



#### Affix laser information and warning signs!

Laser information and warning signs are affixed to the device. In addition, self-adhesive laser information and warning signs (stick-on labels) are supplied in several languages.



- ☞ Affix the laser information sheet to the device in the language appropriate for the place of use. When using the device in the US, use the stick-on label with the "Complies with 21 CFR 1040.10" note.
- ☞ Affix the laser information and warning signs near the device if no signs are attached to the device (e.g. because the device is too small) or if the attached laser information and warning signs are concealed due to the installation position.
- ☞ Affix the laser information and warning signs so that they are legible without exposing the reader to the laser radiation of the device or other optical radiation.

## Further information



- For UL applications, use is only permitted in Class 2 circuits in accordance with the NEC (National Electric Code).
- Use as safety-related component within the safety function is possible, if the component combination is designed correspondingly by the machine manufacturer.

## Accessories

### Connection technology - Connection cables

	Part no.	Designation	Article	Description
	50104171	KB SSI/IBS-5000-BA	Connection cable	Application: Oil and lubricant resistant Suitable for interface: SSI, Interbus-S Connection 1: Connector, M12, Axial, Female, B-coded, 5 -pin Connector, LED: No Connection 2: Open end Shielded: Yes Cable length: 5,000 mm Sheathing material: PUR
	50132079	KD U-M12-5A-V1-050	Connection cable	Application: Chemical resistant Connection 1: Connector, M12, Axial, Female, A-coded, 5 -pin Connector, LED: No Connection 2: Open end Shielded: No Cable length: 5,000 mm Sheathing material: PVC

### Muting - Mounting systems

	Part no.	Designation	Article	Description
	50144970	BT 0100M-F	Mounting device	Design of mounting device: Angle, L-shape Fastening, at system: Through-hole mounting Mounting bracket, at device: Screw type, Threaded holes Type of mounting device: Rigid Material: Metal
	50151594	BTA 0100 M.5	Mounting device	Fastening, at system: Through-hole mounting Mounting bracket, at device: Screw type Type of mounting device: Adjustable Material: Stainless steel

### Deflecting mirrors

	Part no.	Designation	Article	Description
	50144969	US AMS 02	Deflecting mirror	Type of fastening: Through-hole mounting

### Services

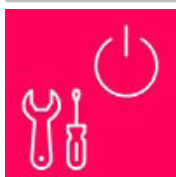
	Part no.	Designation	Article	Description
	S981001	CS10-S-110	Start-up support	Details: Performed at location of customer's choosing, duration: max. 10 hours. Conditions: Devices and connection cables are already mounted, price not including travel costs and, if applicable, accommodation expenses.

## Accessories

	Part no.	Designation	Article	Description
	S981005	CS10-T-110	Product training	Details: Location and content to be agreed upon, duration: max. 10 hours. Conditions: Price not including travel costs and, if applicable, accommodation expenses.

Note	
	A list with all available accessories can be found on the Leuze website in the Download tab of the article detailed page.