

## Technical data sheet

### Line profile sensor

Part no.: 50143924

LRS 36/PB.10

#### Contents

- Technical data
- Dimensioned drawings
- Electrical connection
- Diagrams
- Notes
- Accessories



For illustration purposes only



CDRH Ethernet

## Technical data

### Basic data

Series	36
Contains	LxSsoft configuration software
Application	3D object detection

### Special version

Special version	Synchronization input
-----------------	-----------------------

### Optical data

Light source	Laser, Red
Laser class	2M

### Measurement data

X-axis detection range	150 ... 600 mm
Z-axis detection range	200 ... 800 mm
Minimum object size, x-axis	2 ... 3 mm
Minimum object size, z-axis	2 ... 6 mm

### Electrical data

#### Performance data

Supply voltage $U_B$	18 ... 30 V, DC
----------------------	-----------------

#### Inputs

Number of activation inputs	1 Piece(s)
Number of digital switching inputs	2 Piece(s)

#### Outputs

Number of digital switching outputs	2 Piece(s)
-------------------------------------	------------

#### Switching outputs

##### Switching output 1

Switching element	Transistor, Push-pull
-------------------	-----------------------

##### Switching output 2

Switching element	Transistor, Push-pull
-------------------	-----------------------

### Time behavior

Response time	10 ms
---------------	-------

### Interface

Type	PROFIBUS DP, Ethernet
------	-----------------------

### Connection

Number of connections	3 Piece(s)
-----------------------	------------

#### Connection 1

Function	Signal IN
	Signal OUT
	Voltage supply

Type of connection	Connector
--------------------	-----------

Thread size	M12
-------------	-----

Type	Male
------	------

Material	Metal
----------	-------

No. of pins	8 -pin
-------------	--------

Encoding	A-coded
----------	---------

#### Connection 2

Function	Configuration interface
	Data interface

Type of connection	Connector
--------------------	-----------

Thread size	M12
-------------	-----

Type	Female
------	--------

Material	Metal
----------	-------

No. of pins	4 -pin
-------------	--------

Encoding	D-coded
----------	---------

#### Connection 4

Function	PROFIBUS IN
	PROFIBUS OUT

Type of connection	Connector
--------------------	-----------

Thread size	M12
-------------	-----

Type	Female
------	--------

Material	Metal
----------	-------

No. of pins	5 -pin
-------------	--------

Encoding	B-coded
----------	---------

### Mechanical data

Dimension (W x H x L)	56 mm x 160 mm x 74 mm
-----------------------	------------------------

Housing material	Metal
	Plastic

Metal housing	Aluminum
---------------	----------

Lens cover material	Plastic
---------------------	---------

Net weight	620 g
------------	-------

### Environmental data

Ambient temperature, operation	-30 ... 50 °C
--------------------------------	---------------

Ambient temperature, storage	-30 ... 70 °C
------------------------------	---------------

### Certifications

Degree of protection	IP 67
----------------------	-------

Protection class	III
------------------	-----

Approvals	c UL US
-----------	---------

Standards applied	IEC 60947-5-2
-------------------	---------------

### Classification

Customs tariff number	90318020
-----------------------	----------

ECLASS 5.1.4	27280190
--------------	----------

ECLASS 8.0	27280190
------------	----------

ECLASS 9.0	27280190
------------	----------

ECLASS 10.0	27280190
-------------	----------

ECLASS 11.0	27280190
-------------	----------

ECLASS 12.0	27280190
-------------	----------

ECLASS 13.0	27280190
-------------	----------

ECLASS 14.0	27280190
-------------	----------

ECLASS 15.0	27280190
-------------	----------

ETIM 5.0	EC001825
----------	----------

ETIM 6.0	EC001825
----------	----------

ETIM 7.0	EC001825
----------	----------

ETIM 8.0	EC001825
----------	----------

ETIM 9.0	EC001825
----------	----------

ETIM 10.0	EC001825
-----------	----------

## Dimensioned drawings

All dimensions in millimeters

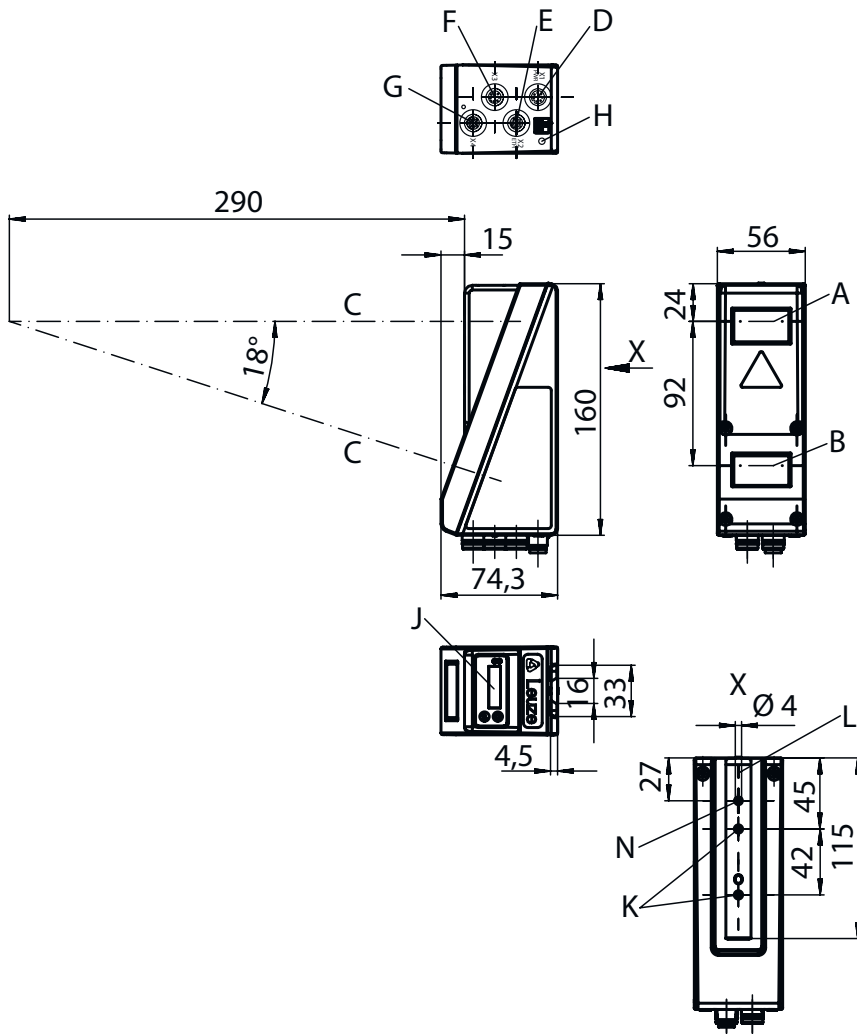

- A Transmitter
- B Receiver
- C Optical axis
- D, E, F, G X1-X4 connections
- H FE screw
- J OLED display and membrane keyboard
- K M4 thread (4.5 mm deep)
- L Support for mounting system

## Electrical connection

### Connection 1

Function	Signal IN
	Signal OUT
	Voltage supply
Type of connection	Connector
Thread size	M12
Type	Male
Material	Metal
No. of pins	8 -pin
Encoding	A-coded

# Electrical connection

## Pin Pin assignment

1	V+
2	IN 1
3	GND
4	OUT 1
5	IN 2
6	OUT 2
7	n.c.
8	n.c.

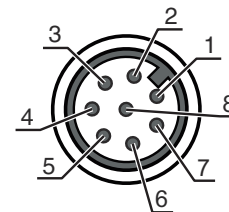

## Connection 2

Function	Configuration interface Data interface
Type of connection	Connector
Thread size	M12
Type	Female
Material	Metal
No. of pins	4 -pin
Encoding	D-coded

## Pin Pin assignment

1	Tx+
2	Rx+
3	Tx-
4	Rx-

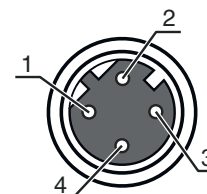

## Connection 4

Function	PROFIBUS IN PROFIBUS OUT
Type of connection	Connector
Thread size	M12
Type	Female
Material	Metal
No. of pins	5 -pin
Encoding	B-coded

## Pin Pin assignment

1	VP
2	A (N)
3	GND
4	B (P)
5	FE

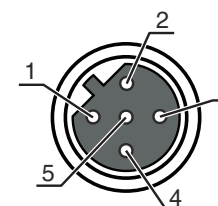

# Diagrams

## Measurement range

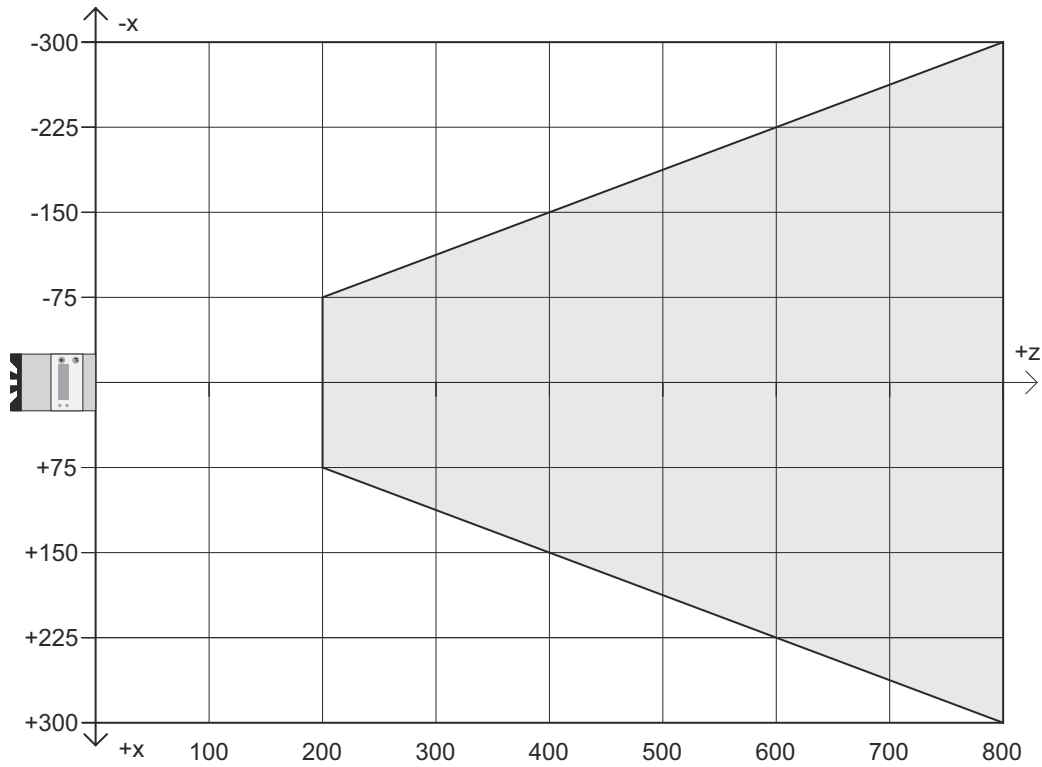

X Line length in mm  
Z Object distance

## Notes

**Observe intended use!**

- This product is not a safety sensor and is not intended as personnel protection.
- The product may only be put into operation by competent persons.
- Only use the product in accordance with its intended use.

**NOTE**

- For UL applications, use is only permitted in Class 2 circuits in accordance with the NEC (National Electric Code).

## Notes

### ATTENTION! LASER RADIATION – CLASS 2M LASER PRODUCT



#### Do not stare into beam or expose users of telescopic optics!

The device satisfies the requirements of IEC 60825-1:2014 / EN 60825-1:2014+A11:2021 safety regulations for a product of **laser class 2M** and complies with U.S. 21 CFR 1040.10 except for conformance with IEC 60825-1 Ed. 3., as described in Laser Notice No. 56, dated May 8, 2019.

- ⚠ Never look directly into the laser beam or in the direction of reflected laser beams! If you look into the beam path over a longer time period, there is a risk of injury to the retina.
- ⚠ Do not point the laser beam of the device at persons!
- ⚠ Interrupt the laser beam using a non-transparent, non-reflective object if the laser beam is accidentally directed towards a person.
- ⚠ When mounting and aligning the device, avoid reflections of the laser beam off reflective surfaces!
- ⚠ CAUTION! The use of operating and adjusting devices other than those specified here or the carrying out of differing procedures may lead to dangerous exposure to radiation! The use of optical instruments or devices (e.g., magnifying glasses, binoculars) in combination with the device increases the danger of eye damage.
- ⚠ Observe the applicable statutory and local laser protection regulations.
- ⚠ The device must not be tampered with and must not be changed in any way.  
There are no user-serviceable parts inside the device.  
There are no user-serviceable parts inside the device.  
Repairs must only be performed by Leuze electronic GmbH + Co. KG.
- ⚠ The device emits a divergent, pulsed laser beam. For laser power, pulse duration and wavelength, see technical data.

## Accessories

### Connection technology - Connection cables

	Part no.	Designation	Article	Description
	50135128	KD S-M12-8A-P1-050	Connection cable	Connection 1: Connector, M12, Axial, Female, A-coded, 8 -pin Connector, LED: No Connection 2: Open end Shielded: Yes Cable length: 5,000 mm Sheathing material: PUR

### Connection technology - Interconnection cables

	Part no.	Designation	Article	Description
	50125541	K-DS M12A-8P-0,75m-LxS36-CP	Configuration cable	Parameter memory: Yes Connection 1: Connector, M12, Axial, Female, A-coded, 8 -pin Connection 2: Connector, M12, Axial, Male, A-coded, 8 -pin Shielded: Yes Cable length: 750 mm Sheathing material: PUR
	50135081	KSS ET-M12-4A-RJ45-A-P7-050	Interconnection cable	Suitable for interface: Ethernet Connection 1: Connector, M12, Axial, Male, D-coded, 4 -pin Connection 2: RJ45 Shielded: Yes Cable length: 5,000 mm Sheathing material: PUR

## Accessories

### Connection technology - Adapters

	Part no.	Designation	Article	Description
	50109834	KDS BUS OUT M12-T-5P	Adapter	Suitable for: MultiNet Plus, PROFIBUS DP Number of connections: 3 Piece(s) Connection 1: Connector, M12, Axial, Male, B-coded, 5 -pin Connection 2: Connector, M12, Axial, Female, B-coded, 5 -pin Connection 3: Connector, M12, Axial, Male, B-coded, 5 -pin

### Mounting technology - Rod mounts

	Part no.	Designation	Article	Description
	50121435	BT 56 - 1	Mounting device	Functions: Static applications Design of mounting device: Mounting system Fastening, at system: For 12 mm rod, For 14 mm rod, For 16 mm rod Mounting bracket, at device: Clampable Material: Metal Tightening torque of the clamping jaws: 8 N·m

### Services

	Part no.	Designation	Article	Description
	S981001	CS10-S-110	Start-up support	Details: Performed at location of customer's choosing, duration: max. 10 hours. Conditions: Devices and connection cables are already mounted, price not including travel costs and, if applicable, accommodation expenses.
	S981005	CS10-T-110	Product training	Details: Location and content to be agreed upon, duration: max. 10 hours. Conditions: Price not including travel costs and, if applicable, accommodation expenses.

#### Note



A list with all available accessories can be found on the Leuze website in the Download tab of the article detailed page.