

## Technical data sheet

### Distance diffuse sensor with background suppression

Part no.: 50153219

ODT55CL1-2M.3/L6-5000



For illustration purposes only

#### Contents

- Technical data
- Dimensioned drawings
- Electrical connection
- Diagrams
- Operation and display
- Part number code
- Notes
- Further information
- Accessories



## Technical data

### Basic data

|                     |   |
|---------------------|---|
| Series              | 55C   |
| Operating principle | Distance diffuse sensor with background suppression |

### Special version

|                 |   |
|-----------------|---|
| Special version | 2 independent switching outputs<br>Measurement value output<br>Wash-Down design |
|-----------------|---|

### Optical data

|                                      |  |
|--------------------------------------|--|
| Black-white error                    | ±20 mm   |
| Operating range                      | 0.07 ... 2 m (guaranteed operating range)      |
| Adjustment range                     | 50 ... 2,500 mm                                |
| Beam path                            | Focused  |
| Light source                         | Laser, Red                                     |
| Wavelength                           | 680 nm   |
| Laser class                          | 1, IEC 60825-1:2014 / EN 60825-1:2014+A11:2021 |
| Transmitted-signal shape             | Pulsed   |
| Light spot size [at sensor distance] | 10 mm x 10 mm [100 mm]                         |
| Type of light spot geometry          | Round  |
| Shift angle                          | Typ. ± 1.5°                                    |

### Measurement data

|  |                 |
|--|-----------------|
| Measurement range                      | 50 ... 2,500 mm |
| Resolution                             | 1.0 mm          |
| Accuracy                               | -20 ... 20 mm   |
| Reproducibility (1 sigma)              | 0 ... 8 mm      |
| Measurement value output               | via IO-Link     |
| Optical distance measurement principle | Time of flight  |

### Electrical data

|                    |   |
|--------------------|---|
| Protective circuit | Polarity reversal protection<br>Short circuit protected<br>Transient protection |
|--------------------|---|

### Performance data

|                      |  |
|----------------------|--|
| Supply voltage $U_B$ | 10 ... 30 V, DC, Incl. residual ripple |
| Residual ripple      | 0 ... 15 %, From $U_B$                 |
| Open-circuit current | 0 ... 35 mA                            |

### Outputs

|                                     |            |
|-------------------------------------|------------|
| Number of digital switching outputs | 2 Piece(s) |
|-------------------------------------|------------|

### Switching outputs

|                         |   |
|-------------------------|---|
| Type                    | Digital switching output                |
| Voltage type            | DC                                      |
| Switching current, max. | 90 mA                                   |
| Switching voltage       | high: $\geq(U_B-2V)$<br>low: $\leq 2 V$ |

### Switching output 1

|                     |  |
|---------------------|--|
| Switching element   | Transistor, Push-pull                                |
| Switching principle | IO-Link / light switching (PNP)/dark switching (NPN) |

### Switching output 2

|                     |  |
|---------------------|--|
| Switching element   | Transistor, Push-pull                      |
| Switching principle | Light switching (PNP)/dark switching (NPN) |

### Time behavior

|                     |  |
|---------------------|--|
| Switching frequency | 7 ... 15 Hz, depending on diffuse reflectance  |
| Response time       | 33 ... 70 ms, depending on diffuse reflectance |
| Readiness delay     | 300 ms   |

### Interface

|                  |                      |
|------------------|----------------------|
| Type             | IO-Link              |
| IO-Link          |                      |
| COM mode         | COM3                 |
| Profile          | Smart sensor profile |
| Min. cycle time  | COM3 = 0.6 ms        |
| Frame type       | 2.V                  |
| Specification    | V1.1                 |
| Device ID        | 2225                 |
| SIO-mode support | Yes                  |

### Connection

#### Connection 1

|                      |   |
|----------------------|---|
| Function             | Signal IN<br>Signal OUT<br>Voltage supply |
| Type of connection   | Cable                                     |
| Cable length         | 5,000 mm                                  |
| Sheathing material   | PVC                                       |
| Cable color          | Black                                     |
| Number of conductors | 4 -wire                                   |
| Wire cross section   | 0.14 mm <sup>2</sup>                      |

### Mechanical data

|                                 |   |
|---------------------------------|---|
| Dimension (W x H x L)           | 14 mm x 35.4 mm x 25 mm   |
| Housing material                | Stainless steel   |
| Stainless steel housing         | AISI 316L, DIN X2CrNiMo17132, W. No1.4404                               |
| Material of operational control | Plastic (POM Hostaform C9021, copolyester Tritan TX1001), non-diffusive |
| Housing roughness               | $R_a \leq 0,8$ , Typical value for the stainless steel housing          |
| Lens cover material             | Plastic (PMMA+) with scratch-resistant Indium protective coating        |
| Net weight                      | 74 g  |
| Housing color                   | Silver  |
| Type of fastening               | Through-hole mounting via optional mounting device                      |
| Compatibility of materials      | CleanProof+<br>ECOLAB<br>Johnson Diversey                               |

### Operation and display

|                                     |  |
|-------------------------------------|--|
| Type of display                     | LED                                      |
| Number of LEDs                      | 2 Piece(s)                               |
| Operational controls                | Teach button                             |
| Function of the operational control | Light/dark switching<br>Range adjustment |

## Technical data

### Environmental data

|                                |               |
|--------------------------------|---------------|
| Ambient temperature, operation | -30 ... 50 °C |
| Ambient temperature, storage   | -40 ... 70 °C |

### Certifications

|                      |               |
|----------------------|---------------|
| Degree of protection | IP 67         |
|                      | IP 68         |
|                      | IP 69K        |
| Protection class     | III           |
| Approvals            | c UL US       |
| Standards applied    | IEC 60947-5-2 |

### Classification

|                       |          |
|-----------------------|----------|
| Customs tariff number | 85365019 |
| ECLASS 5.1.4          | 27270904 |
| ECLASS 8.0            | 27270904 |
| ECLASS 9.0            | 27270904 |
| ECLASS 10.0           | 27270904 |
| ECLASS 11.0           | 27270904 |
| ECLASS 12.0           | 27270903 |
| ECLASS 13.0           | 27270903 |
| ECLASS 14.0           | 27270903 |
| ECLASS 15.0           | 27270903 |
| ECLASS 16.0           | 27270903 |
| ETIM 5.0              | EC002719 |
| ETIM 6.0              | EC002719 |
| ETIM 7.0              | EC002719 |
| ETIM 8.0              | EC002719 |
| ETIM 9.0              | EC002719 |
| ETIM 10.0             | EC002719 |
| UNSPSC 26.08          | 39121528 |

# Dimensioned drawings

All dimensions in millimeters

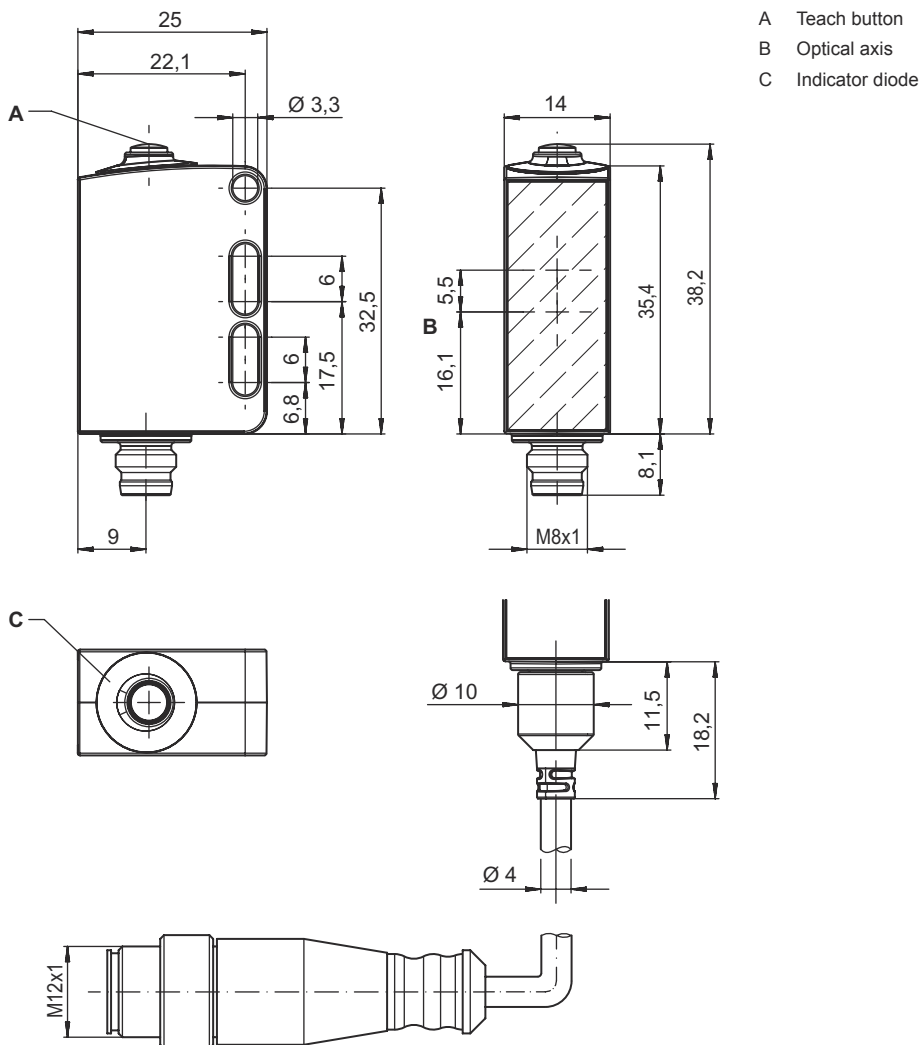

- A Teach button
- B Optical axis
- C Indicator diode

## Electrical connection

### Connection 1

|                      |                      |
|----------------------|----------------------|
| Function             | Signal IN            |
|                      | Signal OUT           |
|                      | Voltage supply       |
| Type of connection   | Cable                |
| Cable length         | 5,000 mm             |
| Sheathing material   | PVC                  |
| Cable color          | Black                |
| Number of conductors | 4 -wire              |
| Wire cross section   | 0.14 mm <sup>2</sup> |

### Conductor color

### Conductor assignment

|       |       |
|-------|-------|
| Brown | V+    |
| White | OUT 2 |
| Blue  | GND   |
| Black | OUT 1 |

# Diagrams

## Typ. response behavior (white 90 %)

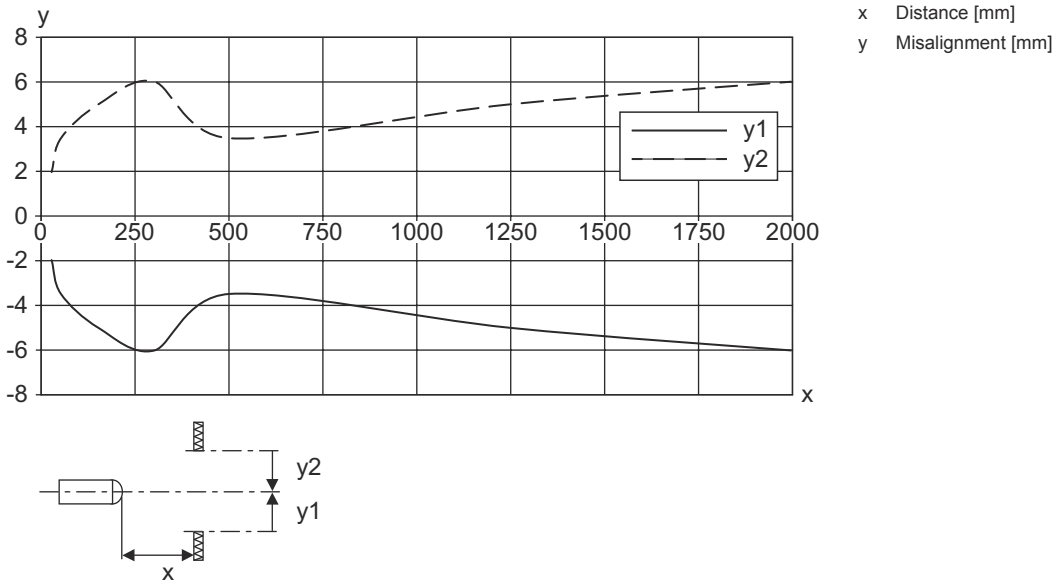

## Typical reproducibility (1 Sigma / 25°C)

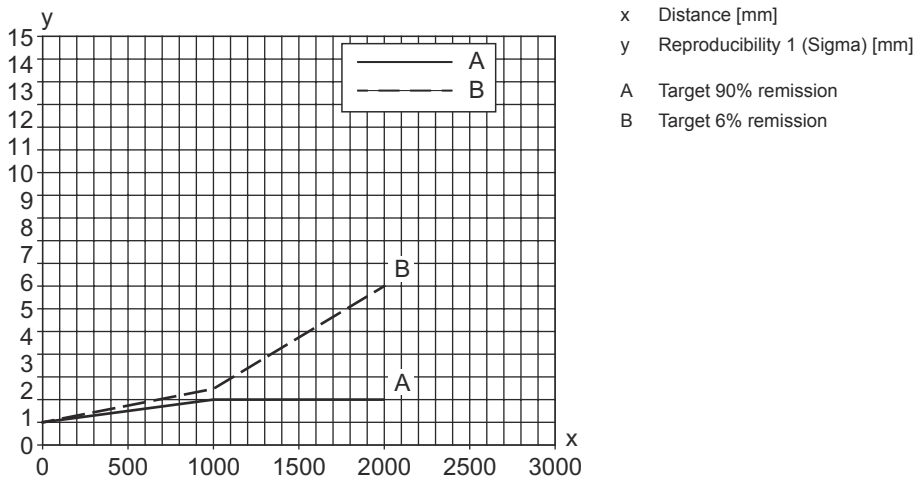

## S/W behavioral diagram

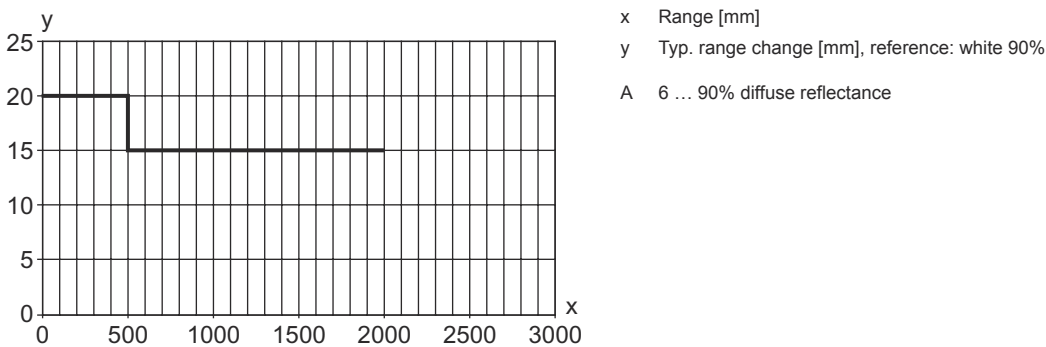

## Operation and display

| LED | Display                  | Meaning               |
|-----|--------------------------|-----------------------|
| 1   | Green, continuous light  | Operational readiness |
| 2   | Yellow, continuous light | Object detected       |

## Part number code

Part designation: **AAA55C d EE-f.GGGG H/i J-K**

|               |   |
|---------------|---|
| <b>AAA55C</b> | <b>Operating principle / construction</b><br>HT55C: Diffuse reflection sensor with background suppression<br>LS55C: Throughbeam photoelectric sensor transmitter<br>LE55C: Throughbeam photoelectric sensor receiver<br>PRK55C: Retro-reflective photoelectric sensor with polarization filter<br>ODT55C: Distance diffuse sensor with background suppression   |
| <b>d</b>      | <b>Light type</b><br>n/a: red light<br>I: infrared light  |
| <b>EE</b>     | <b>Light source</b><br>n/a: LED<br>L1: laser class 1<br>L2: laser class 2   |
| <b>f</b>      | <b>Preset range (optional)</b><br>n/a: operating range acc. to data sheet<br>xxxF: Preset range [mm]<br>2M: operating range of 2 meters   |
| <b>GGGG</b>   | <b>Equipment</b><br>n/a: standard<br>A: Autocollimation principle (single lens) for positioning tasks<br>F: Permanently set range<br>H2O: Detection of aqueous liquids<br>Fill-level monitoring<br>S: small light spot<br>T: autocollimation principle (single lens) for highly transparent bottles without tracking<br>TT: autocollimation principle (single lens) for highly transparent bottles with tracking<br>V: V-optics<br>XL: Extra long light spot<br>X: extended model   |
| <b>H</b>      | <b>Operating range adjustment</b><br>n/a with HT: range adjustable via 8-turn potentiometer<br>n/a with retro-reflective photoelectric sensors (PRK): operating range not adjustable<br>1: 270° potentiometer<br>3: teach-in via button   |
| <b>i</b>      | <b>Switching output/function OUT 1/IN: Pin 4 or black conductor</b><br>2: NPN transistor output, light switching<br>N: NPN transistor output, dark switching<br>4: PNP transistor output, light switching<br>P: PNP transistor output, dark switching<br>6: push-pull switching output, PNP light switching, NPN dark switching<br>G: Push-pull switching output, PNP dark switching, NPN light switching<br>L: IO-Link interface (SIO mode: PNP light switching, NPN dark switching)<br>8: activation input (activation with high signal)<br>X: pin not used<br>1: IO-Link / light switching (NPN) / dark switching (PNP)<br>7: Input for sensitivity adjustment |
| <b>J</b>      | <b>Switching output / function OUT 2/IN: pin 2 or white conductor</b><br>2: NPN transistor output, light switching<br>N: NPN transistor output, dark switching<br>4: PNP transistor output, light switching<br>P: PNP transistor output, dark switching<br>6: push-pull switching output, PNP light switching, NPN dark switching<br>G: Push-pull switching output, PNP dark switching, NPN light switching<br>T: teach-in via cable<br>X: pin not used<br>8: activation input (activation with high signal)<br>9: deactivation input (deactivation with high signal)<br>7: Input for sensitivity adjustment  |

## Part number code

|          |  |
|----------|--|
| <b>K</b> | <b>Electrical connection</b><br>n/a: cable, standard length 2000 mm, 4-wire<br>5000: cable, standard length 5000 mm, 4-wire<br>M8: M8 connector, 4-pin (plug)<br>M8.3: M8 connector, 3-pin (plug)<br>200-M12: cable, length 200 mm with M12 connector, 4-pin, axial (plug) |
|----------|--|

### Note



A list with all available device types can be found on the Leuze website at [www.leuze.com](http://www.leuze.com).

## Notes



### Observe intended use!



- ⌘ This product is not a safety sensor and is not intended as personnel protection.
- ⌘ The product may only be put into operation by competent persons.
- ⌘ Only use the product in accordance with its intended use.

### For UL applications:



- ⌘ For UL applications, use is only permitted in Class 2 circuits in accordance with the NEC (National Electric Code).
- ⌘ These proximity switches shall be used with UL Listed Cable assemblies rated 30V, 0.5A min, in the field installation, or equivalent (categories: CYJV/ CYJV7 or PVVA/PVVA7)



### ATTENTION! LASER RADIATION – CLASS 1 LASER PRODUCT



The device satisfies the requirements of IEC 60825-1:2014 / EN 60825-1:2014+A11:2021 safety regulations for a product of **laser class 1** and complies with 21 CFR 1040.10 except for conformance with IEC 60825-1 Ed. 3., as described in Laser Notice No. 56, dated May 8, 2019.

- ⌘ Observe the applicable statutory and local laser protection regulations.
- ⌘ The device must not be tampered with and must not be changed in any way.  
There are no user-serviceable parts inside the device.  
**CAUTION!** Opening the device can result in dangerous radiation exposure!  
Repairs must only be performed by Leuze electronic GmbH + Co. KG.

## Further information



- Sum of the output currents for both outputs, 50 mA for ambient temperatures > 40 °C
- With a supply voltage >18 V and an ambient temperature <40 °C, the maximum switching current is 100 mA per switching output.
- When starting the sensor below -20°C, a warmup time of one minute is required until the first teach-in
- IP 69K only with internal tube installation of M8 connector

## Accessories



### Connection technology - Connection unit

|  | Part no. | Designation           | Article        | Description   |
|--|----------|-----------------------|----------------|---|
|  | 50144900 | MD 798i-11-82/L5-2222 | IO-Link master | Current consumption, max.: 11,000 mA<br>Interface: IO-Link, Automatic protocol detection, EtherNet IP, Modbus TCP, PROFINET<br>Connections: 12 Piece(s)<br>Sensor connections: 8 Piece(s)<br>Degree of protection: IP 67, IP 65, IP 69K |

### Connection technology - Connection cables



|   | Part no. | Designation           | Article          | Description   |
|---|----------|-----------------------|------------------|---|
|    | 50148347 | KD U-M8-4A-T0-050 F+B | Connection cable | Application: Chemical resistant, Hygienic and wet areas<br>Connection 1: Connector, M8, Axial, Female, A-coded, 4 -pin<br>Connector, LED: No<br>Connection 2: Open end<br>Shielded: No<br>Cable length: 5,000 mm<br>Sheathing material: TPE |
|   | 50130850 | KD U-M8-4A-V1-050     | Connection cable | Application: Chemical resistant<br>Connection 1: Connector, M8, Axial, Female, 4 -pin<br>Connector, LED: No<br>Connection 2: Open end<br>Shielded: No<br>Cable length: 5,000 mm<br>Sheathing material: PVC                                  |
|  | 50130871 | KD U-M8-4W-V1-050     | Connection cable | Application: Chemical resistant<br>Connection 1: Connector, M8, Angled, Female, 4 -pin<br>Connector, LED: No<br>Connection 2: Open end<br>Shielded: No<br>Cable length: 5,000 mm<br>Sheathing material: PVC                                 |

### Mounting technology - Mounting brackets

|   | Part no. | Designation | Article          | Description   |
|---|----------|-------------|------------------|---|
|  | 50118542 | BT 200M.5   | Mounting bracket | Design of mounting device: Angle, L-shape<br>Fastening, at system: Through-hole mounting<br>Mounting bracket, at device: Screw type, Suited for M3 screws<br>Type of mounting device: Adjustable<br>Material: Stainless steel |
|  | 50040269 | BT 25       | Mounting device  | Design of mounting device: Angle, L-shape<br>Fastening, at system: Through-hole mounting<br>Mounting bracket, at device: Screw type<br>Type of mounting device: Rigid<br>Material: Metal                                      |

## Accessories

### Mounting technology - Rod mounts

|   | Part no. | Designation    | Article         | Description  |
|---|----------|----------------|-----------------|--|
|  | 50117255 | BTU 200M-D12   | Mounting system | <p>Contains: 2x M3 x 16 screw, 2 M3 x 20 screws, 2x position washers<br/>           Design of mounting device: Mounting system<br/>           Fastening, at system: For 12 mm rod, Sheet-metal mounting<br/>           Mounting bracket, at device: Screw type, Suited for M3 screws<br/>           Type of mounting device: Clampable, Adjustable, Turning, 360°<br/>           Material: Metal</p> |
|  | 50120426 | BTU 200M.5-D12 | Mounting system | <p>Contains: 2x M3 x 18 screw, 2x M3 mounting nut, 2x position washers<br/>           Design of mounting device: Mounting system<br/>           Fastening, at system: For 12 mm rod<br/>           Mounting bracket, at device: Screw type, Suited for M3 screws<br/>           Type of mounting device: Turning, 360°, Adjustable, Clampable<br/>           Material: Stainless steel</p>           |

#### Note



A list with all available accessories can be found on the Leuze website in the Download tab of the article detailed page.