

Technical data sheet Stationary bar code reader

Part no.: 50147478

BCL 658i SF 102

Contents

- Technical data
- Dimensioned drawings
- Electrical connection
- Diagrams
- Operation and display
- Part number code
- Notes
- Accessories



For illustration purposes only



CDRH



EtherNet/IP
certification partner



Technical data

Basic data

| | |
|--------|----------|
| Series | BCL 600i |
|--------|----------|

Functions

| | |
|-----------|---------------------------|
| Functions | Alignment mode |
| | AutoConfig |
| | AutoControl |
| | AutoReflAct |
| | Code fragment technology |
| | LED indicator |
| | Reference code comparison |

Characteristic parameters

| | |
|------|------------|
| MTTF | 42.4 years |
|------|------------|

Read data

| | |
|---|-----------------------------|
| Code types, readable | 2/5 Interleaved |
| | Codabar |
| | Code 128 |
| | Code 39 |
| | Code 93 |
| | EAN 128 |
| | EAN 8/13 |
| | EAN Addendum |
| | GS1 Databar Expanded |
| | GS1 Databar Limited |
| | GS1 Databar Omnidirectional |
| | UPC |
| Scanning rate, typical | 800 scans/s |
| Bar codes per reading gate, max. number | 64 Piece(s) |

Optical data

| | |
|--|----------------------------|
| Reading distance | 450 ... 1,450 mm |
| Light source | Laser, Blue |
| Wavelength | 405 nm |
| Laser class | 2, IEC/EN 60825-1:2014 |
| Transmitted-signal shape | Continuous |
| Usable opening angle (reading field opening) | 60 ° |
| Bar code contrast (PCS) | 60 % |
| Modulus size | 0.3 ... 0.5 mm |
| Reading method | Line scanner |
| Beam deflection | Via rotating polygon wheel |
| Light beam exit | Front |

Electrical data

| | |
|--------------------|------------------------------|
| Protective circuit | Polarity reversal protection |
|--------------------|------------------------------|

Performance data

| | |
|-------------------------|-----------------|
| Supply voltage U_B | 10 ... 30 V, DC |
| Power consumption, max. | 14 W |

Inputs/outputs selectable

| | |
|-------------------------------------|------------------|
| Output current, max. | 60 mA |
| Number of inputs/outputs selectable | 4 Piece(s) |
| Voltage type, outputs | DC |
| Switching voltage, outputs | Typ. $U_B / 0$ V |
| Voltage type, inputs | DC |
| Switching voltage, inputs | Typ. $U_B / 0$ V |
| Input current, max. | 8 mA |

Interface

| | |
|------|-------------|
| Type | EtherNet IP |
|------|-------------|

EtherNet IP

| | |
|----------------------|---------------------------|
| Function | Process |
| Address assignment | DHCP |
| | Manual address assignment |
| Switch functionality | Integrated |
| Transmission speed | 10 Mbit/s |
| | 100 Mbit/s |

Service interface

| | |
|------|-----|
| Type | USB |
|------|-----|

USB

| | |
|----------|----------------------------|
| Function | Configuration via software |
| | Service |

Connection

| | |
|-----------------------|------------|
| Number of connections | 5 Piece(s) |
|-----------------------|------------|

Connection 1

| | |
|-----------------------|--------------------|
| Function | Service interface |
| Type of connection | USB |
| Designation on device | SERVICE |
| Connector type | USB 2.0 Standard-A |

Connection 2

| | |
|-----------------------|------------|
| Function | Signal IN |
| | Signal OUT |
| Type of connection | Connector |
| Designation on device | SW IN/OUT |
| Thread size | M12 |
| Type | Female |
| Material | Metal |
| No. of pins | 5 -pin |
| Encoding | A-coded |

Connection 3

| | |
|-----------------------|-------------------|
| Function | PWR / SW IN / OUT |
| Type of connection | Connector |
| Designation on device | PWR |
| Thread size | M12 |
| Type | Male |
| Material | Metal |
| No. of pins | 5 -pin |
| Encoding | A-coded |

Technical data

Connection 4

| | |
|-----------------------|---------------|
| Function | BUS IN |
| Type of connection | Connector |
| Designation on device | HOST / BUS IN |
| Thread size | M12 |
| Type | Female |
| Material | Metal |
| No. of pins | 4 -pin |
| Encoding | D-coded |

Connection 5

| | |
|-----------------------|-----------|
| Function | BUS OUT |
| Type of connection | Connector |
| Designation on device | BUS OUT |
| Thread size | M12 |
| Type | Female |
| No. of pins | 4 -pin |

Mechanical data

| | |
|-----------------------|------------------------------|
| Design | Cubic |
| Dimension (W x H x L) | 123.5 mm x 63 mm x 104.2 mm |
| Housing material | Metal |
| Metal housing | Diecast aluminum |
| Lens cover material | Glass |
| Net weight | 1,400 g |
| Housing color | Red |
| | Silver |
| Type of fastening | Dovetail grooves |
| | Mounting thread |
| | Via optional mounting device |

Operation and display

| | |
|-----------------------|---|
| Type of display | LED |
| | Monochromatic graphical display, 128x64 pixel, with background lighting |
| Number of LEDs | 2 Piece(s) |
| Type of configuration | Via web browser |
| Operational controls | Button(s) |
| | Via service interface |

Environmental data

| | |
|--|---------------|
| Ambient temperature, operation | 0 ... 40 °C |
| Ambient temperature, storage | -20 ... 70 °C |
| Relative humidity (non-condensing) | 90 % |
| Extraneous light tolerance on the bar code, max. | 2,000 lx |

Certifications

| | |
|---|--------------------------|
| Degree of protection | IP 65 |
| Protection class | III |
| Certifications | c UL US |
| Test procedure for EMC in accordance with standard | EN 55022 |
| | EN 61000-4-2, -3, -4, -6 |
| | EN 61000-6-2 |
| Test procedure for shock in accordance with standard | IEC 60068-2-27, test Ea |
| Test procedure for continuous shock in accordance with standard | IEC 60068-2-29, test Eb |
| Test procedure for vibration in accordance with standard | IEC 60068-2-6, test Fc |

Classification

| | |
|-----------------------|----------|
| Customs tariff number | 84719000 |
| ECLASS 5.1.4 | 27280102 |
| ECLASS 8.0 | 27280102 |
| ECLASS 9.0 | 27280102 |
| ECLASS 10.0 | 27280102 |
| ECLASS 11.0 | 27280102 |
| ECLASS 12.0 | 27280102 |
| ECLASS 13.0 | 27280102 |
| ECLASS 14.0 | 27280102 |
| ETIM 5.0 | EC002550 |
| ETIM 6.0 | EC002550 |
| ETIM 7.0 | EC002550 |
| ETIM 8.0 | EC002550 |
| ETIM 9.0 | EC002550 |

Dimensioned drawings

All dimensions in millimeters

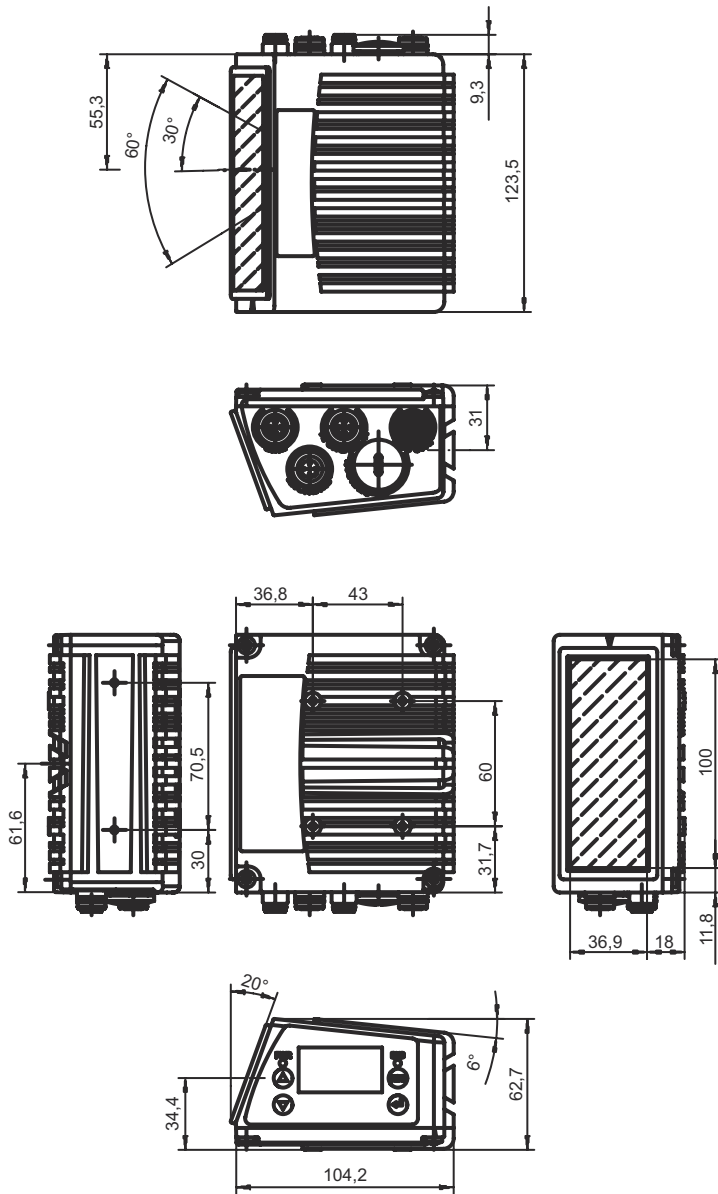

Electrical connection

Connection 1

SERVICE

| | |
|--------------------|--------------------|
| Function | Service interface |
| Type of connection | USB |
| Connector type | USB 2.0 Standard-A |

| Pin | Pin assignment |
|-----|----------------|
| 1 | +5 V DC |
| 2 | DATA- |
| 3 | DATA+ |
| 4 | GND |

Electrical connection

Connection 2

SW IN/OUT

| | |
|--------------------|-------------------------|
| Function | Signal IN Signal OUT |
| Type of connection | Connector |
| Thread size | M12 |
| Type | Female |
| Material | Metal |
| No. of pins | 5 -pin |
| Encoding | A-coded |

| Pin | Pin assignment |
|-----|----------------|
|-----|----------------|

| | |
|---|--------|
| 1 | VOUT |
| 2 | SWIO 1 |
| 3 | GND |
| 4 | SWIO 2 |
| 5 | FE |



Connection 3

PWR

| | |
|--------------------|-------------------|
| Function | PWR / SW IN / OUT |
| Type of connection | Connector |
| Thread size | M12 |
| Type | Male |
| Material | Metal |
| No. of pins | 5 -pin |
| Encoding | A-coded |

| Pin | Pin assignment |
|-----|----------------|
|-----|----------------|

| | |
|---|--------|
| 1 | VIN |
| 2 | SWIO 3 |
| 3 | GND |
| 4 | SWIO 4 |
| 5 | FE |

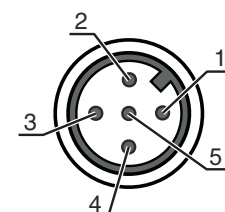

Connection 4

HOST / BUS IN

| | |
|--------------------|-----------|
| Function | BUS IN |
| Type of connection | Connector |
| Thread size | M12 |
| Type | Female |
| Material | Metal |
| No. of pins | 4 -pin |
| Encoding | D-coded |

| Pin | Pin assignment |
|-----|----------------|
|-----|----------------|

| | |
|---|-----|
| 1 | TD+ |
| 2 | RD+ |
| 3 | TD- |
| 4 | RD- |

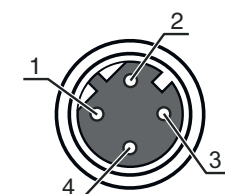

Electrical connection

Connection 5

BUS OUT

| | |
|--------------------|-----------|
| Function | BUS OUT |
| Type of connection | Connector |
| Thread size | M12 |
| Type | Female |
| Material | Metal |
| No. of pins | 4 -pin |
| Encoding | D-coded |

| Pin | Pin assignment |
|-----|----------------|
| 1 | TD+ |
| 2 | RD+ |
| 3 | TD- |
| 4 | RD- |

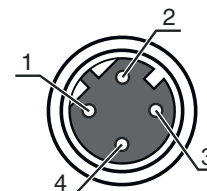

Diagrams

Reading field curve - Low Density

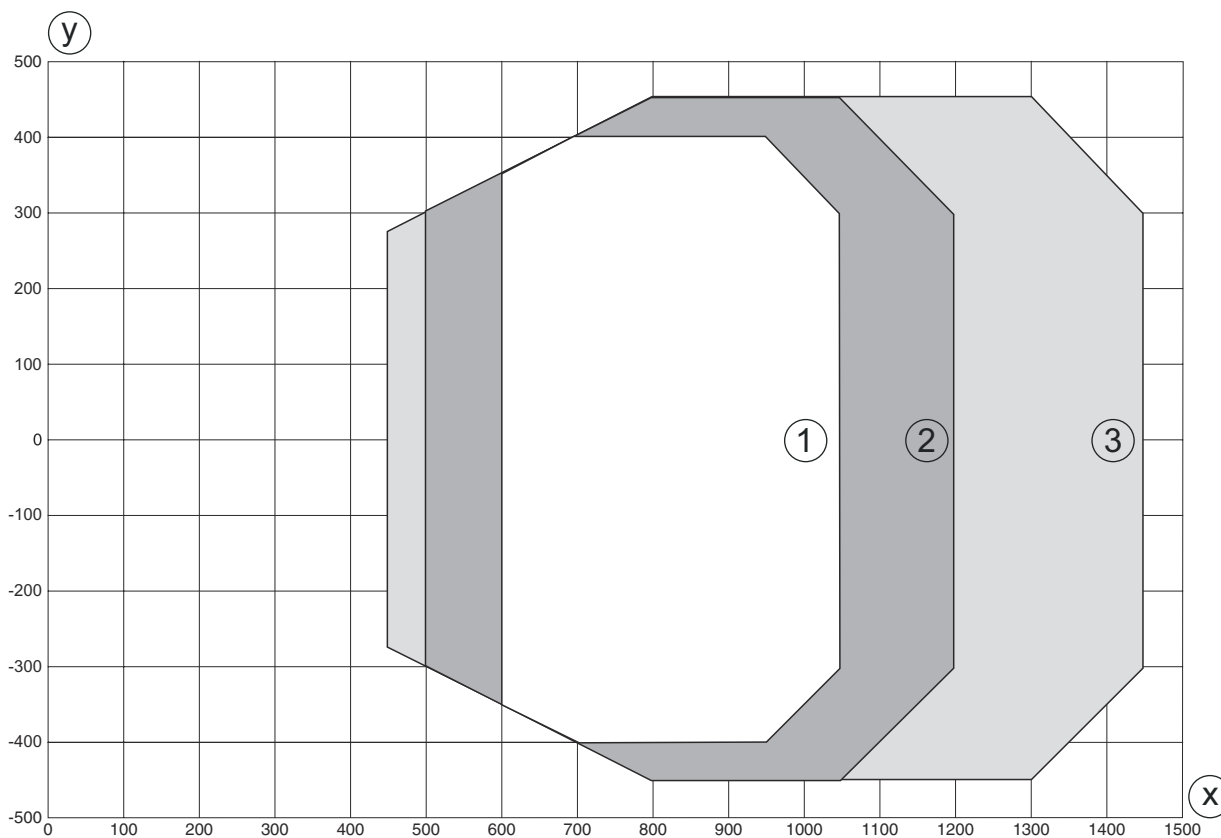

y Reading field width [mm]
 x Reading field distance [mm]

- 1 Module = 0.3 mm: 600 mm - 1050 mm (450 mm depth of field)
- 2 Module = 0.35 mm: 500 mm - 1200 mm (700 mm depth of field)
- 3 Module = 0.5 mm: 450 mm - 1450 mm (1000 mm depth of field)

Operation and display

| LED | Display | Meaning |
|-------|--------------------------|------------------------|
| 1 PWR | Off | No supply voltage |
| | Green, flashing | Initialization |
| | Green, continuous light | Device OK |
| | Orange, flashing | Service operation |
| | Orange, continuous light | Reset |
| | Red, flashing | Device OK, warning set |
| | Red, continuous light | Device error |
| 2 NET | Off | No supply voltage |
| | Green, flashing | BUS initialization |
| | Green, continuous light | Bus operation ok |
| | Orange, flashing | Service mode |
| | Orange, continuous light | Reset |
| | Red, flashing | Communication error |
| | Red, continuous light | Network error |

Part number code

Part designation: **BCL XXXX YYZ AAA B**

| | |
|-------------|--|
| BCL | Operating principle BCL: bar code reader |
| XXXX | Series/interface (integrated fieldbus technology) 600i: RS 232/RS 422/ RS 485 (multiNet master) 601i: RS 485 (multiNet slave) 604i: PROFIBUS DP 608i: Ethernet 648i: PROFINET 658i: EtherNet/IP |
| YY | Scanning principle S: line scanner (single line) O: oscillating-mirror scanner (oscillating mirror) |
| Z | Optics N: High Density (close) M: Medium Density (medium distance) F: Low Density (remote) L: Long Range (very large distances) |
| AAA | Beam exit 100: lateral 102: front |
| BB | Special equipment H: With heating |

Note



A list with all available device types can be found on the Leuze website at www.leuze.com.

Notes



Observe intended use!



- ⌘ This product is not a safety sensor and is not intended as personnel protection.
- ⌘ The product may only be put into operation by competent persons.
- ⌘ Only use the product in accordance with its intended use.

Notes

| ATTENTION! LASER RADIATION – CLASS 2 LASER PRODUCT | |
|---|---|
| | <p>Do not stare into beam! The device satisfies the requirements of IEC/EN 60825-1:2014 safety regulations for a product of laser class 2 as well as the U.S. 21 CFR 1040.10 regulations with deviations corresponding to Laser Notice No. 56 from May 08, 2019.</p> <ul style="list-style-type: none"> ⌘ Never look directly into the laser beam or in the direction of reflected laser beams! If you look into the beam path over a longer time period, there is a risk of injury to the retina. ⌘ Do not point the laser beam of the device at persons! ⌘ Interrupt the laser beam using a non-transparent, non-reflective object if the laser beam is accidentally directed towards a person. ⌘ When mounting and aligning the device, avoid reflections of the laser beam off reflective surfaces! ⌘ CAUTION! Use of controls or adjustments or performance of procedures other than specified herein may result in hazardous light exposure. ⌘ Observe the applicable statutory and local laser protection regulations. ⌘ The device must not be tampered with and must not be changed in any way. There are no user-serviceable parts inside the device. Repairs must only be performed by Leuze electronic GmbH + Co. KG. |

| NOTE | |
|------|---|
| | <p>Affix laser information and warning signs! Laser information and warning signs are affixed to the device. In addition, self-adhesive laser information and warning signs (stick-on labels) are supplied in several languages.</p> <ul style="list-style-type: none"> ⌘ Affix the laser information sheet to the device in the language appropriate for the place of use. When using the device in the US, use the stick-on label with the "Complies with 21 CFR 1040.10" note. ⌘ Affix the laser information and warning signs near the device if no signs are attached to the device (e.g. because the device is too small) or if the attached laser information and warning signs are concealed due to the installation position. ⌘ Affix the laser information and warning signs so that they are legible without exposing the reader to the laser radiation of the device or other optical radiation. |

Accessories

Connection technology - Connection cables

| | Part no. | Designation | Article | Description |
|--|----------|--------------------|------------------|---|
| | 50132079 | KD U-M12-5A-V1-050 | Connection cable | Connection 1: Connector, M12, Axial, Female, A-coded, 5 -pin Connector, LED: No Connection 2: Open end Shielded: No Cable length: 5.000 mm Sheathing material: PVC |

Connection technology - Interconnection cables

| | Part no. | Designation | Article | Description |
|--|----------|------------------|-----------------------|---|
| | 50107726 | KB USB A - USB A | Interconnection cable | Suitable for interface: USB Connection 1: USB Connection 2: USB Shielded: Yes Cable length: 1,800 mm Sheathing material: PVC |



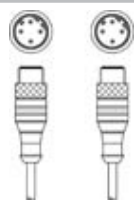
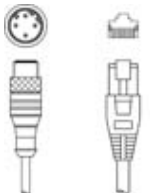

Accessories

| | Part no. | Designation | Article | Description |
|--|----------|-----------------------------|-----------------------|--|
|  | 50137078 | KSS ET-M12-4A-M12-4A-P7-050 | Interconnection cable | Suitable for interface: Ethernet Connection 1: Connector, M12, Axial, Male, D-coded, 4 -pin Connection 2: Connector, M12, Axial, Male, D-coded, 4 -pin Shielded: Yes Cable length: 5,000 mm Sheathing material: PUR |
|  | 50135081 | KSS ET-M12-4A-RJ45-A-P7-050 | Interconnection cable | Suitable for interface: Ethernet Connection 1: Connector, M12, Axial, Male, D-coded, 4 -pin Connection 2: RJ45 Shielded: Yes Cable length: 5,000 mm Sheathing material: PUR |

Mounting technology - Other

| | Part no. | Designation | Article | Description |
|--|----------|-------------|------------------|--|
|  | 50111224 | BT 59 | Mounting bracket | Fastening, at system: Groove mounting Mounting bracket, at device: Clampable Material: Metal Shock absorber: No |

Services

| | Part no. | Designation | Article | Description |
|--|----------|-------------|------------------|---|
|  | S981020 | CS30-E-212 | Hourly rate | Details: Compilation of the application data, selection and suggestion of suitable sensor system, drawing prepared as assembly sketch. Conditions: Completed questionnaire or project specifications with a description of the application have been provided. |
|  | S981014 | CS30-S-110 | Start-up support | Details: Performed at location of customer's choosing, duration: max. 10 hours. Conditions: Devices and connection cables are already mounted, price not including travel costs and, if applicable, accommodation expenses. |
|  | S981019 | CS30-T-110 | Product training | Details: Location and content to be agreed upon, duration: max. 10 hours. Conditions: Price not including travel costs and, if applicable, accommodation expenses. |
|  | S981021 | CS30-V-212 | Hourly rate | Details: REA evaluation with creation of a test report, evaluation of the code quality. Conditions: Original bar codes to be provided by the client. |

Accessories

Note



🔗 A list with all available accessories can be found on the Leuze website in the Download tab of the article detailed page.