

Technical data sheet

Glass fiber optics for throughbeam operation

Part no.: 50126496

GF-LB-SS-610-SD

Contents

- Technical data
- Dimensioned drawings
- Notes
- Further information



For illustration purposes only

Technical data

Basic data

Series	GF
Operating principle	Throughbeam principle
Device type	Transmit and receive fiber
Area of application	General applications

Special version

Special version	Heat resistant
-----------------	----------------

Optical data

Light beam exit	Lateral without lens
Fiber core	Mixed fiber configuration Multiple fiber core
Fiber core material	Glass
Active fiber diameter	1.5 mm
Operating range with LV463	0 ... 400 mm
Operating range with LV463.XV	0 ... 680 mm
Operating range with LV463.XR	0 ... 1,000 mm
Operating range with LV463I.XR	0 ... 2,000 mm

Mechanical data

Design	Cylindrical
Outer diameter	4.5 mm
Net weight	70 g
Head material	Stainless steel
Type	Glass fiber optics (GF)
Fiber length	1,000 mm
Fiber sheathing material	Stainless steel
Fastening of the probe	Ø 6 mm
Smallest bending radius (static)	R40
Smallest bending radius (moving)	R40
Sleeve length at optical outlet	20 mm
Metric thread on fiber optic sleeve	No
Laying	standard

Environmental data

Ambient temperature, operation	-30 ... 200 °C
--------------------------------	----------------

Classification

Customs tariff number	90011090
ECLASS 5.1.4	27270905
ECLASS 8.0	27270905
ECLASS 9.0	27270905
ECLASS 10.0	27270905
ECLASS 11.0	27273606
ECLASS 12.0	27273606
ECLASS 13.0	27273606
ECLASS 14.0	27273606
ECLASS 15.0	27273606
ECLASS 16.0	27273606
ETIM 5.0	EC002651
ETIM 6.0	EC002651
ETIM 7.0	EC002651
ETIM 8.0	EC002651
ETIM 9.0	EC002651
ETIM 10.0	EC002651
UNSPSC 26.08	41112103

Dimensioned drawings

All dimensions in millimeters

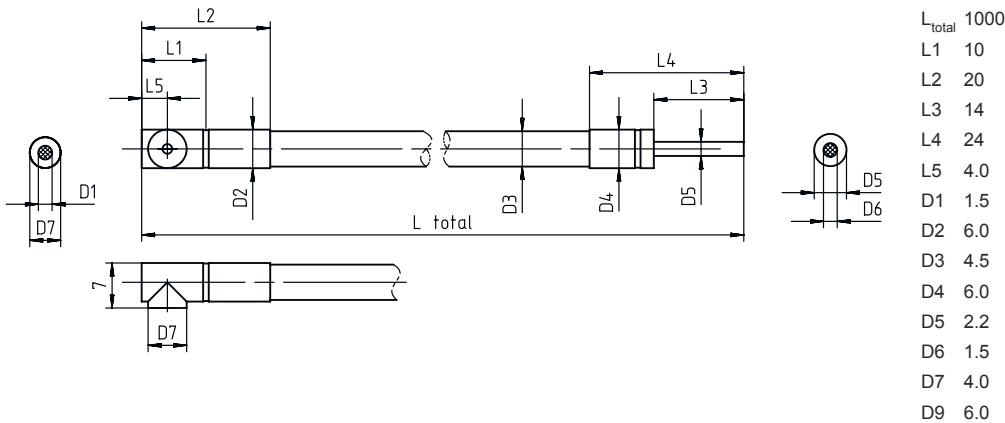

Notes



Observe intended use!



- ⌘ This product is not a safety sensor and is not intended as personnel protection.
- ⌘ The product may only be put into operation by competent persons.
- ⌘ Only use the product in accordance with its intended use.

Further information

- Suitable products for operating these fiber optics are the fiber optic amplifiers LV461, LV462B as well as LV463, LV463.XV and LV463.XR.
- Operating range measured on a white object (90% diffuse reflection) with the following settings on the fiber optic amplifier:
 - max. response time
 - max. amplification
 - min. switching threshold
- The maximum range is limited by the length of the light conductor.