

Technical data sheet Stationary bar code reader

Part no.: 50126971

BCL 608i SF 102



For illustration purposes only

Contents

- Technical data
- Dimensioned drawings
- Electrical connection
- Diagrams
- Operation and display
- Part number code
- Notes
- Accessories



CDRH



Ethernet



Technical data

Basic data

Series	BCL 600i
--------	----------

Functions

Functions	Alignment mode
	AutoConfig
	AutoControl
	AutoReflAct
	Code fragment technology
	LED indicator
	Reference code comparison

Characteristic parameters

MTTF	42.4 years
------	------------

Read data

Code types, readable	2/5 Interleaved
	Codabar
	Code 128
	Code 39
	Code 93
	EAN 128
	EAN 8/13
	EAN Addendum
	GS1 Databar Expanded
	GS1 Databar Limited
	GS1 Databar Omnidirectional
	UPC

Scanning rate, typical	800 scans/s
------------------------	-------------

Bar codes per reading gate, max. number	64 Piece(s)
---	-------------

Optical data

Reading distance	450 ... 1,450 mm
Light source	Laser, Blue
Wavelength	405 nm
Laser class	2, IEC/EN 60825-1:2014
Transmitted-signal shape	Continuous
Usable opening angle (reading field opening)	60 °
Bar code contrast (PCS)	60 %
Modulus size	0.3 ... 0.5 mm
Reading method	Line scanner
Beam deflection	Via rotating polygon wheel
Light beam exit	Front

Electrical data

Protective circuit	Polarity reversal protection
--------------------	------------------------------

Performance data

Supply voltage U_B	10 ... 30 V, DC
----------------------	-----------------

Power consumption, max.	14 W
-------------------------	------

Inputs/outputs selectable

Output current, max.	60 mA
----------------------	-------

Number of inputs/outputs selectable	4 Piece(s)
-------------------------------------	------------

Voltage type, outputs	DC
-----------------------	----

Switching voltage, outputs	Typ. $U_B / 0$ V
----------------------------	------------------

Voltage type, inputs	DC
----------------------	----

Switching voltage, inputs	Typ. $U_B / 0$ V
---------------------------	------------------

Input current, max.	8 mA
---------------------	------

Interface

Type	Ethernet
------	----------

Ethernet

Architecture	Client
	Server

Address assignment	DHCP
	Manual address assignment

Transmission speed	10 Mbit/s
	100 Mbit/s

Function	Process
----------	---------

Switch functionality	Integrated
----------------------	------------

Transmission protocol	TCP/IP
-----------------------	--------

Service interface

Type	USB
------	-----

USB

Function	Configuration via software
	Service

Connection

Number of connections	5 Piece(s)
-----------------------	------------

Connection 1

Function	Service interface
----------	-------------------

Type of connection	USB
--------------------	-----

Designation on device	SERVICE
-----------------------	---------

Connector type	USB 2.0 Standard-A
----------------	--------------------

Connection 2

Function	Signal IN
	Signal OUT

Type of connection	Connector
--------------------	-----------

Designation on device	SW IN/OUT
-----------------------	-----------

Thread size	M12
-------------	-----

Type	Female
------	--------

Material	Metal
----------	-------

No. of pins	5 -pin
-------------	--------

Encoding	A-coded
----------	---------

Connection 3

Function	PWR / SW IN / OUT
----------	-------------------

Type of connection	Connector
--------------------	-----------

Designation on device	PWR
-----------------------	-----

Thread size	M12
-------------	-----

Type	Male
------	------

Material	Metal
----------	-------

No. of pins	5 -pin
-------------	--------

Encoding	A-coded
----------	---------

Technical data

Connection 4

Function	BUS IN
Type of connection	Connector
Designation on device	HOST / BUS IN
Thread size	M12
Type	Female
Material	Metal
No. of pins	4 -pin
Encoding	D-coded

Connection 5

Function	BUS OUT
Type of connection	Connector
Designation on device	BUS OUT
Thread size	M12
Type	Female
No. of pins	4 -pin

Mechanical data

Design	Cubic
Dimension (W x H x L)	123.5 mm x 63 mm x 104.2 mm
Housing material	Metal
Metal housing	Diecast aluminum
Lens cover material	Glass
Net weight	1,400 g
Housing color	Red
	Silver
Type of fastening	Dovetail grooves
	Mounting thread
	Via optional mounting device

Operation and display

Type of display	LED
	Monochromatic graphical display, 128x64 pixel, with background lighting
Number of LEDs	2 Piece(s)
Type of configuration	Via web browser
Operational controls	Button(s)
	Via service interface

Environmental data

Ambient temperature, operation	0 ... 40 °C
Ambient temperature, storage	-20 ... 70 °C
Relative humidity (non-condensing)	90 %
Extraneous light tolerance on the bar code, max.	2,000 lx

Certifications

Degree of protection	IP 65
Protection class	III
Certifications	c UL US
Test procedure for EMC in accordance with standard	EN 55022
	EN 61000-4-2, -3, -4, -6
	EN 61000-6-2
Test procedure for shock in accordance with standard	IEC 60068-2-27, test Ea
Test procedure for continuous shock in accordance with standard	IEC 60068-2-29, test Eb
Test procedure for vibration in accordance with standard	IEC 60068-2-6, test Fc

Classification

Customs tariff number	84719000
ECLASS 5.1.4	27280102
ECLASS 8.0	27280102
ECLASS 9.0	27280102
ECLASS 10.0	27280102
ECLASS 11.0	27280102
ECLASS 12.0	27280102
ECLASS 13.0	27280102
ECLASS 14.0	27280102
ETIM 5.0	EC002550
ETIM 6.0	EC002550
ETIM 7.0	EC002550
ETIM 8.0	EC002550
ETIM 9.0	EC002550

Dimensioned drawings

All dimensions in millimeters

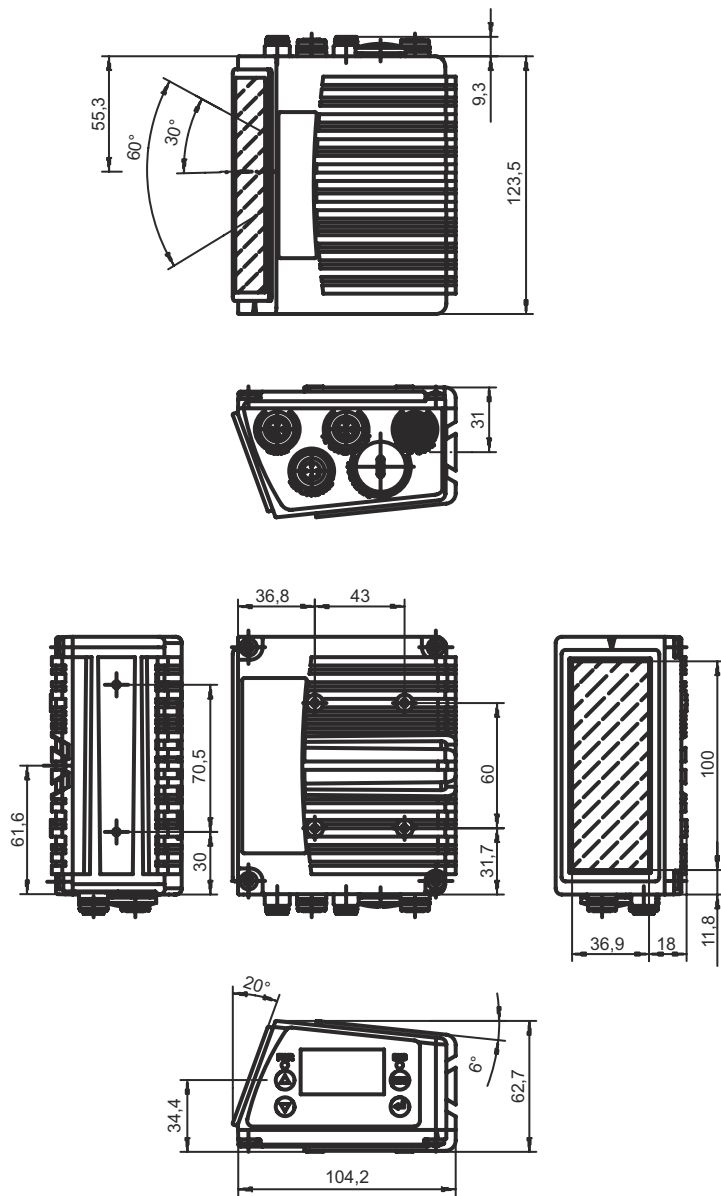

Electrical connection

Connection 1

SERVICE

Function	Service interface
Type of connection	USB
Connector type	USB 2.0 Standard-A

Pin	Pin assignment
1	+5 V DC
2	DATA-
3	DATA+
4	GND

Electrical connection

Connection 2

SW IN/OUT

Function	Signal IN Signal OUT
Type of connection	Connector
Thread size	M12
Type	Female
Material	Metal
No. of pins	5 -pin
Encoding	A-coded

Pin	Pin assignment
1	VOUT
2	SWIO 1
3	GND
4	SWIO 2
5	FE



Connection 3

PWR

Function	PWR / SW IN / OUT
Type of connection	Connector
Thread size	M12
Type	Male
Material	Metal
No. of pins	5 -pin
Encoding	A-coded

Pin	Pin assignment
1	VIN
2	SWIO 3
3	GND
4	SWIO 4
5	FE

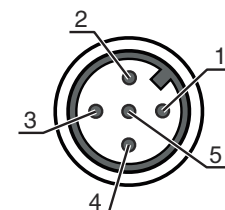

Connection 4

HOST / BUS IN

Function	BUS IN
Type of connection	Connector
Thread size	M12
Type	Female
Material	Metal
No. of pins	4 -pin
Encoding	D-coded

Pin	Pin assignment
1	TD+
2	RD+
3	TD-
4	RD-



Electrical connection

Connection 5

BUS OUT

Function	BUS OUT
Type of connection	Connector
Thread size	M12
Type	Female
Material	Metal
No. of pins	4 -pin
Encoding	D-coded

Pin	Pin assignment
1	TD+
2	RD+
3	TD-
4	RD-

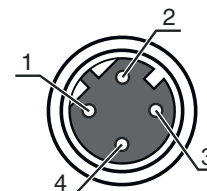

Diagrams

Reading field curve - Low Density

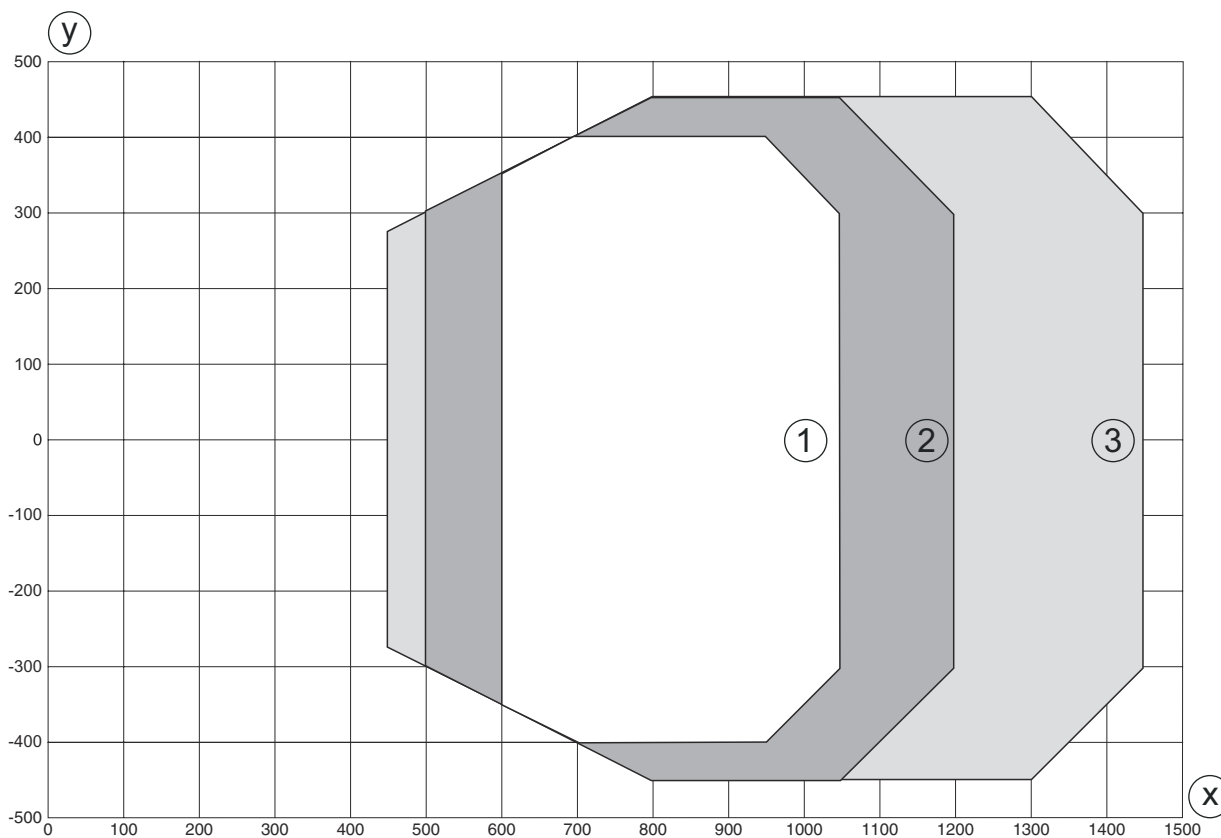

y Reading field width [mm]
 x Reading field distance [mm]

- 1 Module = 0.3 mm: 600 mm - 1050 mm (450 mm depth of field)
- 2 Module = 0.35 mm: 500 mm - 1200 mm (700 mm depth of field)
- 3 Module = 0.5 mm: 450 mm - 1450 mm (1000 mm depth of field)

Diagrams

Reading field curve - Low Density

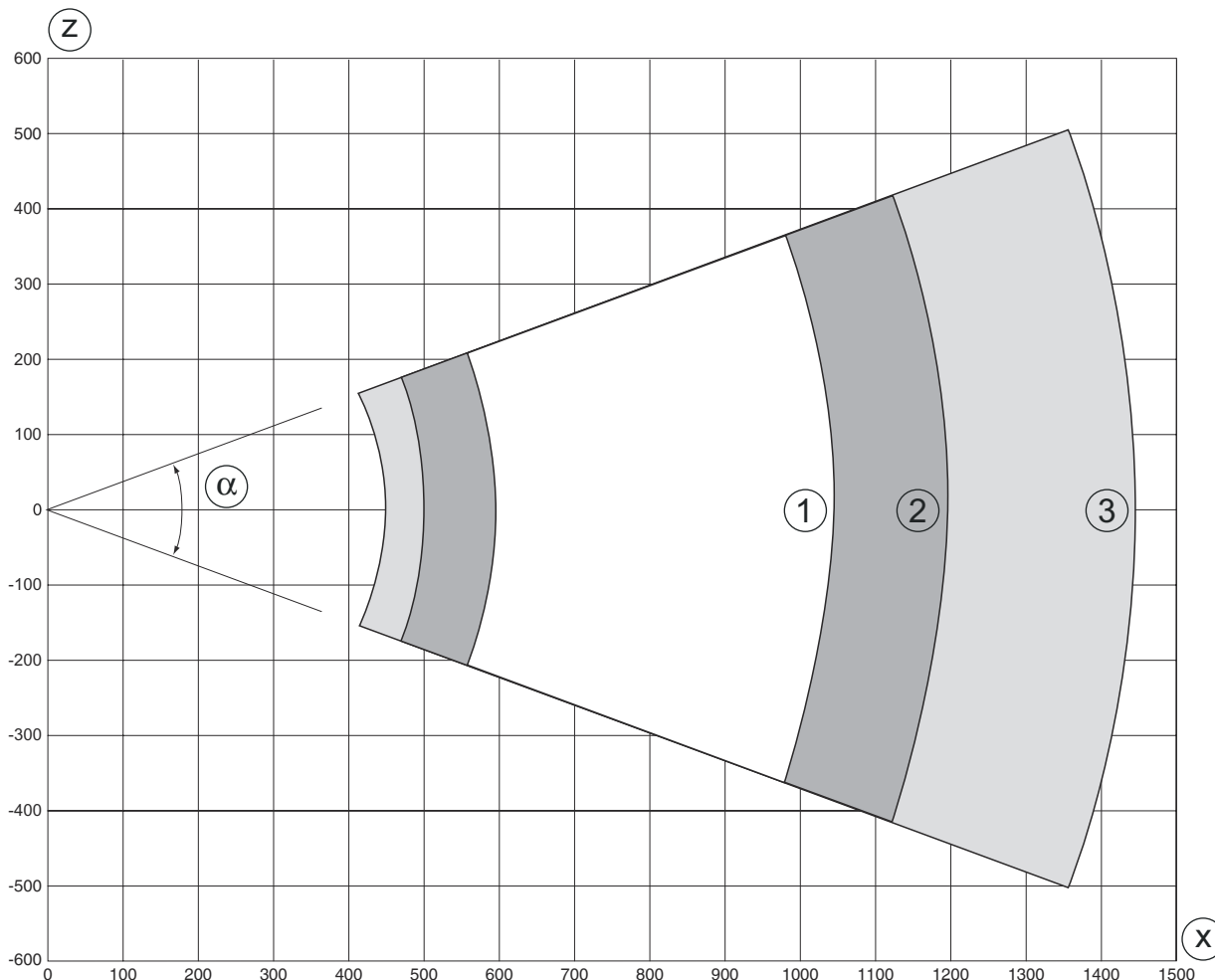

z Reading field height [mm]

x Reading field distance [mm]

- 1 Module = 0.3 mm: 600 mm - 1050 mm (450 mm depth of field)
- 2 Module = 0.35 mm: 500 mm - 1200 mm (700 mm depth of field)
- 3 Module = 0.5 mm: 450 mm - 1450 mm (1000 mm depth of field)

Operation and display

LED	Display	Meaning
1 PWR	Off	No supply voltage
	Green, flashing	Initialization
	Green, continuous light	Device OK
	Orange, flashing	Service operation
	Orange, continuous light	Reset
	Red, flashing	Device OK, warning set
	Red, continuous light	Device error
2 NET	Off	No supply voltage
	Green, flashing	BUS initialization
	Green, continuous light	Bus operation ok
	Orange, flashing	Service mode
	Orange, continuous light	Reset
	Red, flashing	Communication error

Operation and display

LED	Display	Meaning
2 NET	Red, continuous light	Network error

Part number code

Part designation: **BCL XXXX YYZ AAA B**

BCL	Operating principle BCL: bar code reader
XXXX	Series/interface (integrated fieldbus technology) 600i: RS 232/RS 422/ RS 485 (multiNet master) 601i: RS 485 (multiNet slave) 604i: PROFIBUS DP 608i: Ethernet 648i: PROFINET 658i: EtherNet/IP
YY	Scanning principle S: line scanner (single line) O: oscillating-mirror scanner (oscillating mirror)
Z	Optics N: High Density (close) M: Medium Density (medium distance) F: Low Density (remote) L: Long Range (very large distances)
AAA	Beam exit 100: lateral 102: front
BB	Special equipment H: With heating

Note



A list with all available device types can be found on the Leuze website at www.leuze.com.

Notes

 **Observe intended use!**



- This product is not a safety sensor and is not intended as personnel protection.
- The product may only be put into operation by competent persons.
- Only use the product in accordance with its intended use.

Notes

ATTENTION! LASER RADIATION – CLASS 2 LASER PRODUCT	
	<p>Do not stare into beam! The device satisfies the requirements of IEC/EN 60825-1:2014 safety regulations for a product of laser class 2 as well as the U.S. 21 CFR 1040.10 regulations with deviations corresponding to Laser Notice No. 56 from May 08, 2019.</p> <ul style="list-style-type: none"> ⌘ Never look directly into the laser beam or in the direction of reflected laser beams! If you look into the beam path over a longer time period, there is a risk of injury to the retina. ⌘ Do not point the laser beam of the device at persons! ⌘ Interrupt the laser beam using a non-transparent, non-reflective object if the laser beam is accidentally directed towards a person. ⌘ When mounting and aligning the device, avoid reflections of the laser beam off reflective surfaces! ⌘ CAUTION! Use of controls or adjustments or performance of procedures other than specified herein may result in hazardous light exposure. ⌘ Observe the applicable statutory and local laser protection regulations. ⌘ The device must not be tampered with and must not be changed in any way. There are no user-serviceable parts inside the device. Repairs must only be performed by Leuze electronic GmbH + Co. KG.

NOTE	
	<p>Affix laser information and warning signs! Laser information and warning signs are affixed to the device. In addition, self-adhesive laser information and warning signs (stick-on labels) are supplied in several languages.</p> <ul style="list-style-type: none"> ⌘ Affix the laser information sheet to the device in the language appropriate for the place of use. When using the device in the US, use the stick-on label with the "Complies with 21 CFR 1040.10" note. ⌘ Affix the laser information and warning signs near the device if no signs are attached to the device (e.g. because the device is too small) or if the attached laser information and warning signs are concealed due to the installation position. ⌘ Affix the laser information and warning signs so that they are legible without exposing the reader to the laser radiation of the device or other optical radiation.

Accessories

Connection technology - Connection cables

	Part no.	Designation	Article	Description
	50132079	KD U-M12-5A-V1-050	Connection cable	Connection 1: Connector, M12, Axial, Female, A-coded, 5 -pin Connector, LED: No Connection 2: Open end Shielded: No Cable length: 5.000 mm Sheathing material: PVC

Connection technology - Interconnection cables

	Part no.	Designation	Article	Description
	50107726	KB USB A - USB A	Interconnection cable	Suitable for interface: USB Connection 1: USB Connection 2: USB Shielded: Yes Cable length: 1,800 mm Sheathing material: PVC



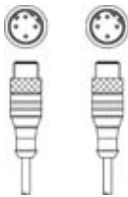
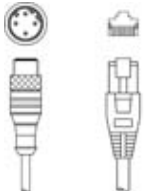

Accessories

	Part no.	Designation	Article	Description
	50137078	KSS ET-M12-4A-M12-4A-P7-050	Interconnection cable	Suitable for interface: Ethernet Connection 1: Connector, M12, Axial, Male, D-coded, 4 -pin Connection 2: Connector, M12, Axial, Male, D-coded, 4 -pin Shielded: Yes Cable length: 5,000 mm Sheathing material: PUR
	50135081	KSS ET-M12-4A-RJ45-A-P7-050	Interconnection cable	Suitable for interface: Ethernet Connection 1: Connector, M12, Axial, Male, D-coded, 4 -pin Connection 2: RJ45 Shielded: Yes Cable length: 5,000 mm Sheathing material: PUR

Mounting technology - Other

	Part no.	Designation	Article	Description
	50111224	BT 59	Mounting bracket	Fastening, at system: Groove mounting Mounting bracket, at device: Clampable Material: Metal Shock absorber: No

Services

	Part no.	Designation	Article	Description
	S981020	CS30-E-212	Hourly rate	Details: Compilation of the application data, selection and suggestion of suitable sensor system, drawing prepared as assembly sketch. Conditions: Completed questionnaire or project specifications with a description of the application have been provided.
	S981014	CS30-S-110	Start-up support	Details: Performed at location of customer's choosing, duration: max. 10 hours. Conditions: Devices and connection cables are already mounted, price not including travel costs and, if applicable, accommodation expenses.
	S981019	CS30-T-110	Product training	Details: Location and content to be agreed upon, duration: max. 10 hours. Conditions: Price not including travel costs and, if applicable, accommodation expenses.
	S981021	CS30-V-212	Hourly rate	Details: REA evaluation with creation of a test report, evaluation of the code quality. Conditions: Original bar codes to be provided by the client.

Accessories

Note



A list with all available accessories can be found on the Leuze website in the Download tab of the article detailed page.