

## Technical data sheet

### Diffuse sensor with background suppression

Part no.: 50138062

HT110L1.3/L6T-M12



For illustration purposes only

#### Contents

- Technical data
- Dimensioned drawings
- Electrical connection
- Diagrams
- Operation and display
- Part number code
- Notes
- Further information
- Accessories



CDRH



## Technical data

### Basic data

Series	110
Operating principle	Diffuse reflection principle with background suppression
Application	Compartment fine positioning Danger zone guarding Push-through protection in pallet warehouse

### Special version

Special version	2 independent switching outputs
-----------------	---------------------------------

### Optical data

Black-white error	Black/white shift 6%/90% and gray/white shift 18%/90%: $\pm 40$ mm
Operating range	Guaranteed operating range
Operating range, white 90%	0 ... 5 m
Operating range, black 6%	0.05 ... 3 m
Operating range limit	0 ... 5 m
Operating range limit	Typical operating range
Adjustment range	60 ... 5,000 mm
Beam path	Collimated
Light source	Laser, Red
Wavelength	655 nm
Laser class	1, IEC/EN 60825-1:2007
Max. laser power	0.391 W
Transmitted-signal shape	Pulsed
Pulse duration	0.006 $\mu$ s
Light spot size [at sensor distance]	4 mm x 5 mm [3,000 mm]
Type of light spot geometry	Oval

### Electrical data

Protective circuit	Polarity reversal protection Short circuit protected
--------------------	---

#### Performance data

Supply voltage $U_B$	18 ... 30 V, DC
Residual ripple	15 %, From $U_B$
Open-circuit current	60 mA
Switching hysteresis	20 mm

#### Inputs

Number of teach inputs	1 Piece(s)
------------------------	------------

#### Teach inputs

Voltage type	DC
Switching voltage	high: $+U_B$

#### Teach input 1

Assignment	Connection 1, pin 5
Active switching state	High

#### Outputs

Number of digital switching outputs	2 Piece(s)
-------------------------------------	------------

#### Switching outputs

Voltage type	DC
Switching current, max.	100 mA
Switching voltage	high: $\geq(U_B-2V)$

### Switching output 1

Assignment	Connection 1, pin 4
Switching element	Transistor, Push-pull
Switching principle	IO-Link / light switching (PNP)/dark switching (NPN)

### Switching output 2

Assignment	Connection 1, pin 2
Switching element	Transistor, Push-pull
Switching principle	Light switching (PNP)/dark switching (NPN)

### Time behavior

Switching frequency	500 Hz
Response time	1 ms
Readiness delay	5,000 ms

### Interface

Type	IO-Link
------	---------

#### IO-Link

COM mode	COM2
Profile	Common Profile
Min. cycle time	COM2 = 2.3 ms
Frame type	2.2
Port type	A
Specification	V1.1
Device ID	0x00087E
SIO-mode support	Yes
Process data IN	2 bytes
Process data OUT	2 bytes
Dual Channel	No

### Connection

#### Connection 1

Function	Signal IN Signal OUT Voltage supply
Type of connection	Connector, Turning, 90°
Thread size	M12
Type	Male
Material	Plastic
No. of pins	5 -pin
Encoding	A-coded

### Mechanical data

Dimension (W x H x L)	23 mm x 50 mm x 50 mm
Housing material	Plastic
Plastic housing	ABS
Lens cover material	Plastic / PMMA
Net weight	42 g
Housing color	Red
Type of fastening	Through-hole mounting Via optional mounting device

## Technical data

### Operation and display

Type of display	LED
Number of LEDs	2 Piece(s)
Operational controls	Control buttons
	PC software
Function of the operational control	Range adjustment

### Environmental data

Ambient temperature, operation	-40 ... 60 °C, UL: max. + 45 °C
Ambient temperature, storage	-40 ... 80 °C

### Certifications

Degree of protection	IP 67
	IP 69K
Protection class	II
Approvals	c UL US
Standards applied	IEC/EN 60947-5-2

### Classification

Customs tariff number	90318080
ECLASS 5.1.4	27270904
ECLASS 8.0	27270904
ECLASS 9.0	27270904
ECLASS 10.0	27270904
ECLASS 11.0	27270904
ECLASS 12.0	27270903
ECLASS 13.0	27270903
ECLASS 14.0	27270903
ECLASS 15.0	27270903
ETIM 5.0	EC002719
ETIM 6.0	EC002719
ETIM 7.0	EC002719
ETIM 8.0	EC002719
ETIM 9.0	EC002719
ETIM 10.0	EC002719

## Dimensioned drawings

All dimensions in millimeters

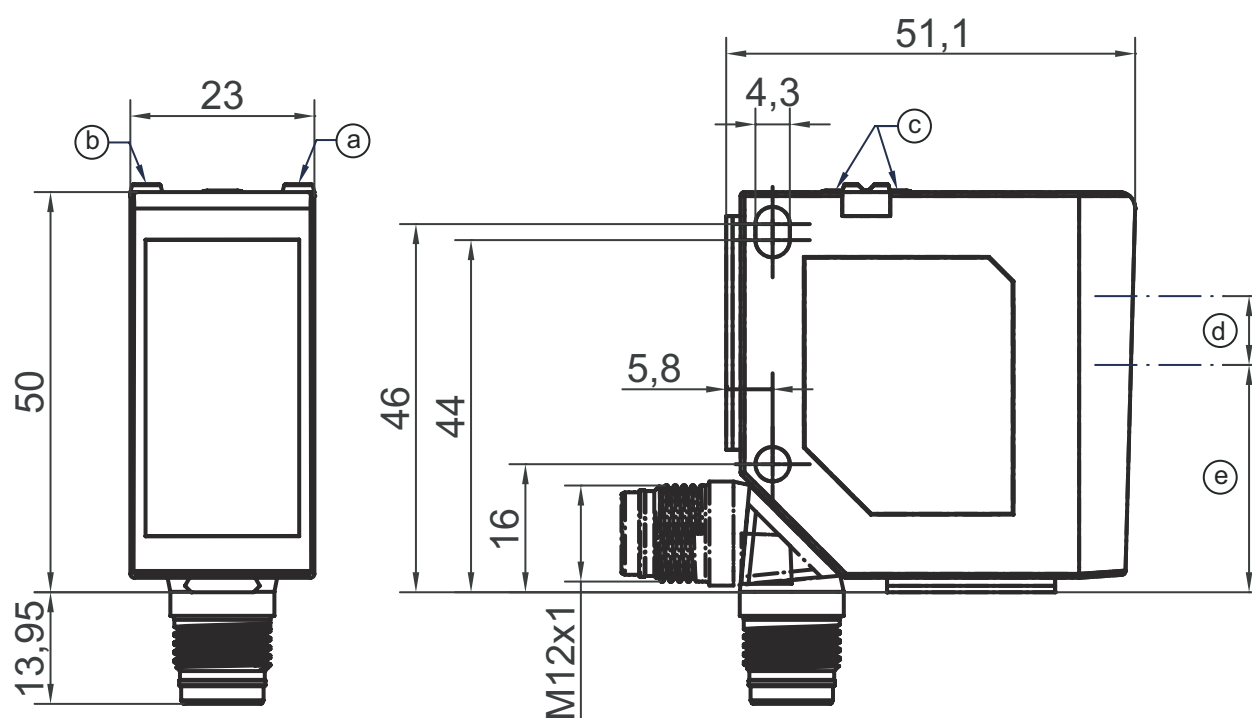

- a Yellow LED
- b Green LED
- c Control buttons
- d Transmitter
- e Receiver

# Electrical connection

## Connection 1

Function	Signal IN
	Signal OUT
	Voltage supply
Type of connection	Connector
Thread size	M12
Type	Male
Material	Plastic
No. of pins	5 -pin
Encoding	A-coded

Pin	Pin assignment
1	V+
2	OUT 2
3	GND
4	IO-Link / OUT 1
5	Teach-in

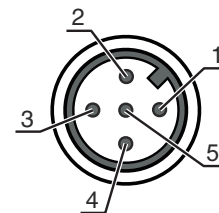

## Diagrams

### Light spot size

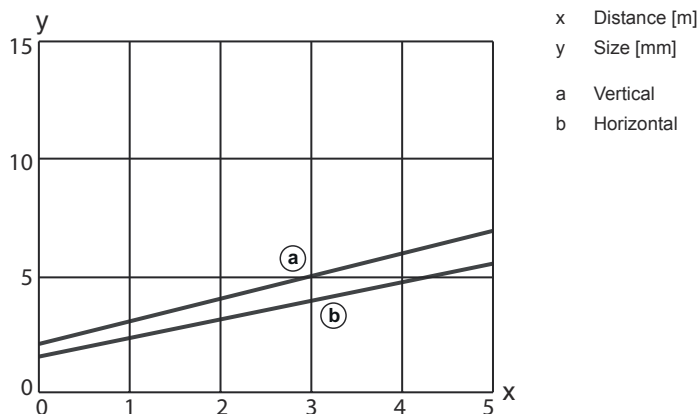

## Operation and display

LED	Display	Meaning
1	Yellow, continuous light	Switching output/switching state
2	Green, continuous light	Operating voltage applied
	Yellow, continuous light	Switching output/switching state

## Part number code

Part designation: XXX110YY.Z/ABC-DDD

XXX110	<b>Operating principle</b> ODS110: Optical distance sensor HT110: diffuse reflection sensor with background suppression
YY	<b>Light source</b> L1: laser class 1
Z	<b>Equipment</b> 3: Control buttons for configuration

## Part number code

<b>A</b>	<b>Switching output/function OUT 1/IN: Pin 4 or black conductor</b> L: IO-Link interface (SIO mode: PNP light switching, NPN dark switching)
<b>B</b>	<b>Switching output / function OUT 2/IN: pin 2 or white conductor</b> 6: push-pull switching output, PNP light switching, NPN dark switching C: Current output T: teach-in V: Voltage output
<b>C</b>	<b>Switching output / function OUT 3/IN: Pin 5</b> X: pin not used T: teach-in
<b>DDD</b>	<b>Electrical connection</b> M12: M12 connector

### Note

	↪ A list with all available device types can be found on the Leuze website at <a href="http://www.leuze.com">www.leuze.com</a> .
--	--

## Notes

### Observe intended use!

	<ul style="list-style-type: none"> <li>↪ This product is not a safety sensor and is not intended as personnel protection.</li> <li>↪ The product may only be put into operation by competent persons.</li> <li>↪ Only use the product in accordance with its intended use.</li> </ul>
--	---

### ATTENTION! LASER RADIATION – CLASS 1 LASER PRODUCT

	↪ Observe the applicable statutory and local laser protection regulations.
--	--

### WARNING! LASER RADIATION – CLASS 1 LASER PRODUCT

	<p>The device satisfies the requirements of IEC 60825-1:2007 (EN 60825-1:2007) safety regulations for a product of <b>laser class 1</b> as well as the U.S. 21 CFR 1040.10 regulations with deviations corresponding to Laser Notice No. 50 from June 24, 2007.</p> <ul style="list-style-type: none"> <li>↪ Observe the applicable statutory and local laser protection regulations.</li> <li>↪ The device must not be tampered with and must not be changed in any way. There are no user-serviceable parts inside the device. Repairs must only be performed by Leuze electronic GmbH + Co. KG.</li> </ul>
--	---

### Configuration via IO-Link (see operating instructions)

	↪ Object teach, average value teach for output 1 and 2, dynamic teach
--	---

## Notes

### Configuration via external teach



See operating instructions

## Further information



- Ambient temperature, operation: UL: max. +45°
- Warmup time: minimum 20 min at +24 VDC and an ambient temperature of 20 °C

## Accessories

### Connection technology - Connection unit

	Part no.	Designation	Article	Description
	50144900	MD 798i-11-82/L5-2222	IO-Link master	Type: IO-Link master Current consumption, max.: 11,000 mA Switching outputs for each sensor connection: 1 Piece(s) Switching output: Transistor, PNP Interface: IO-Link, Automatic protocol detection, EtherNet IP, Modbus TCP, PROFINET Connections: 12 Piece(s) Sensor connections: 8 Piece(s) Connections for voltage supply: 2 Piece(s) Interface connections: 2 Piece(s) Degree of protection: IP 67, IP 65, IP 69K

### Connection technology - Connection cables

	Part no.	Designation	Article	Description
	50133855	KD S-M12-5A-V1-020	Connection cable	Connection 1: Connector, M12, Axial, Female, A-coded, 5 -pin Connector, LED: No Connection 2: Open end Shielded: Yes Cable length: 2.000 mm Sheathing material: PVC
	50133856	KD S-M12-5A-V1-050	Connection cable	Connection 1: Connector, M12, Axial, Female, A-coded, 5 -pin Connector, LED: No Connection 2: Open end Shielded: Yes Cable length: 5.000 mm Sheathing material: PVC
	50132077	KD U-M12-5A-V1-020	Connection cable	Connection 1: Connector, M12, Axial, Female, A-coded, 5 -pin Connector, LED: No Connection 2: Open end Shielded: No Cable length: 2.000 mm Sheathing material: PVC

## Accessories

	Part no.	Designation	Article	Description
	50132079	KD U-M12-5A-V1-050	Connection cable	Connection 1: Connector, M12, Axial, Female, A-coded, 5 -pin Connector, LED: No Connection 2: Open end Shielded: No Cable length: 5.000 mm Sheathing material: PVC

## Mounting technology - Rod mounts

	Part no.	Designation	Article	Description
	50117252	BTU 300M-D12	Mounting system	Design of mounting device: Mounting system Fastening, at system: For 12 mm rod, Sheet-metal mounting Mounting bracket, at device: Screw type, Suited for M4 screws Type of mounting device: Clampable, Adjustable, Turning, 360° Material: Metal

### Note



↪ A list with all available accessories can be found on the Leuze website in the Download tab of the article detailed page.