

Technical data sheet

Polarized retro-reflective photoelectric sensor

Part no.: 50148161

PRK53C.TT3/LG-M8



For illustration purposes only

Contents

- Technical data
- Dimensioned drawings
- Electrical connection
- Diagrams
- Operation and display
- Reflectors & reflective tapes
- Part number code
- Notes
- Further information
- Accessories



Technical data

Basic data

Series	53C
Operating principle	Reflection principle
Application	Detection of highly transparent bottles Detection of transparent films

Special version

Special version	Autocollimation HYGIENE design Tracking function
-----------------	--

Optical data

Operating range	0 ... 3 m (guaranteed operating range), With reflector TK(S) 100x100
Operating range limit	0 ... 3.6 m (typical operating range), With reflector TK(S) 100x100
Light source	LED, Red
Wavelength	645 nm
Transmitted-signal shape	Pulsed
LED group	Exempt group (in acc. with EN 62471)

Electrical data

Protective circuit	Polarity reversal protection Short circuit protected
--------------------	---

Performance data

Supply voltage U_B	10 ... 30 V, DC, Incl. residual ripple
Residual ripple	0 ... 15 %, From U_B
Open-circuit current	0 ... 15 mA

Outputs

Number of digital switching outputs	2 Piece(s)
-------------------------------------	------------

Switching outputs

Type	Digital switching output
Voltage type	DC
Switching current, max.	100 mA
Switching voltage	high: $\geq(U_B - 2V)$ low: $\leq 2 V$

Switching output 1

Assignment	Connection 1, pin 4
Switching element	Transistor, Push-pull
Switching principle	IO-Link / light switching (PNP)/dark switching (NPN)

Switching output 2

Assignment	Connection 1, pin 2
Switching element	Transistor, Push-pull
Switching principle	Dark switching (PNP)/light switching (NPN)

Time behavior

Switching frequency	1,500 Hz
Response time	0.33 ms
Readiness delay	300 ms
Response jitter	110 μ s

Interface

Type	IO-Link
------	---------

IO-Link

COM mode	COM2
Profile	Smart sensor profile
Min. cycle time	COM2 = 2.3 ms
Frame type	2.5
Specification	V1.1
Device ID	6025
SIO-mode support	Yes

Connection

Number of connections	1 Piece(s)
-----------------------	------------

Connection 1

Function	Signal IN Signal OUT Voltage supply
Type of connection	Connector
Thread size	M8
Type	Male
Material	Stainless steel
No. of pins	4 -pin

Mechanical data

Dimension (W x H x L)	14 mm x 35.4 mm x 20.4 mm
Housing material	Stainless steel
Stainless steel housing	AISI 316L, DIN X2CrNiMo17132, W. No1.4404
Material of operational control	Plastic (POM Hostaform C9021, copoly-ester Tritan TX1001), non-diffusive
Housing roughness	$R_a \leq 0,8$, Typical value for the stainless steel housing
Lens cover material	Plastic (PMMA+) with scratch-resistant Indium protective coating
Net weight	48 g
Housing color	Silver
Type of fastening	Housing fit
Compatibility of materials	CleanProof+ ECOLAB Johnson Diversey

Operation and display

Type of display	LED
Number of LEDs	2 Piece(s)
Operational controls	Teach button
Function of the operational control	Light/dark switching Sensitivity adjustment

Environmental data

Ambient temperature, operation	-40 ... 60 °C, (70 °C \leq 15min)
Ambient temperature, storage	-40 ... 70 °C

Certifications

Degree of protection	IP 67 IP 68 IP 69K
Protection class	III
Approvals	c UL US
Standards applied	IEC 60947-5-2

Technical data

Customs tariff number	85365019
ECLASS 5.1.4	27270902
ECLASS 8.0	27270902
ECLASS 9.0	27270902
ECLASS 10.0	27270902
ECLASS 11.0	27270902
ECLASS 12.0	27270902
ECLASS 13.0	27270902
ECLASS 14.0	27270902
ECLASS 15.0	27270902
ECLASS 16.0	27270902
ETIM 5.0	EC002717
ETIM 6.0	EC002717
ETIM 7.0	EC002717
ETIM 8.0	EC002717
ETIM 9.0	EC002717
ETIM 10.0	EC002717
UNSPSC 26.08	39121528

Dimensioned drawings

All dimensions in millimeters

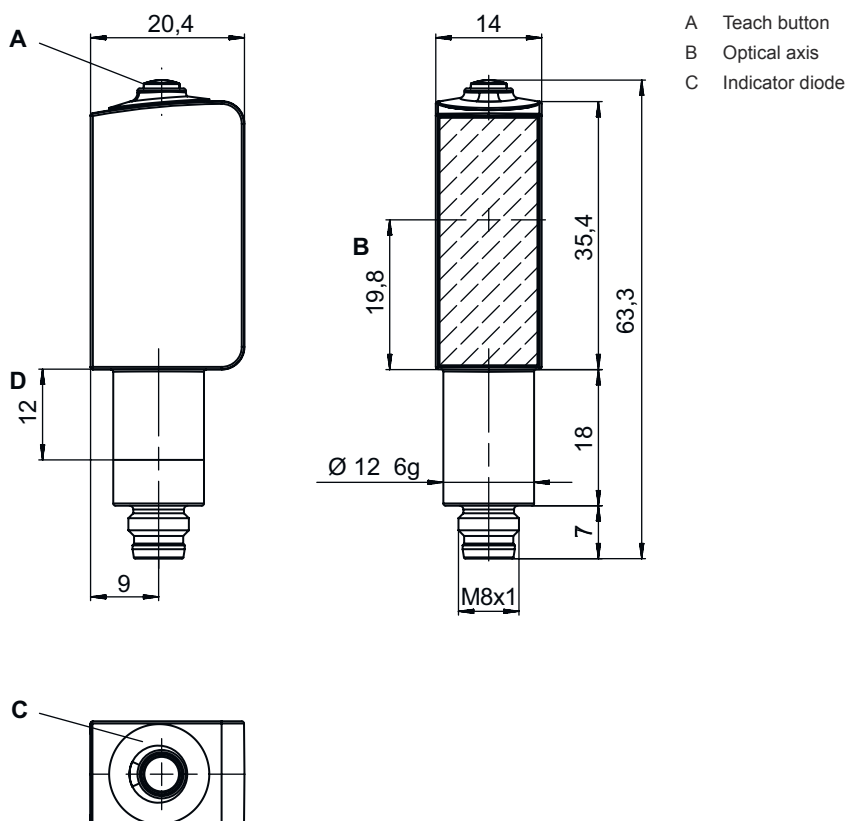

Electrical connection

Connection 1

Function	Signal IN
	Signal OUT
	Voltage supply
Type of connection	Connector
Thread size	M8
Type	Male
Material	Stainless steel
No. of pins	4 -pin

Pin	Pin assignment
1	V+
2	OUT 2
3	GND
4	IO-Link / OUT 1



Diagrams

Typ. response behavior

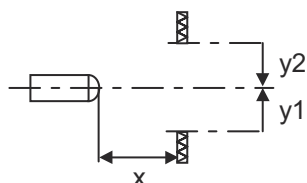
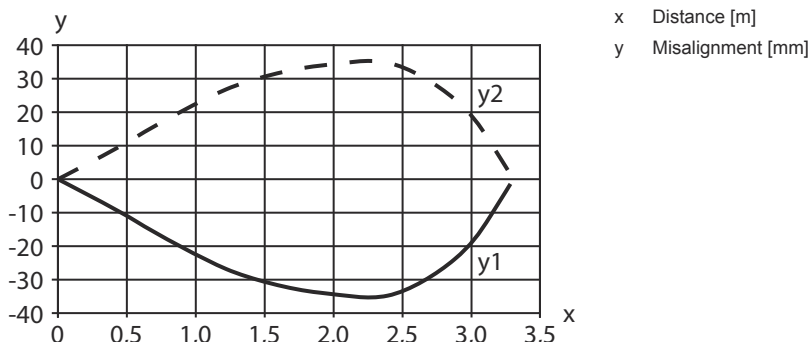



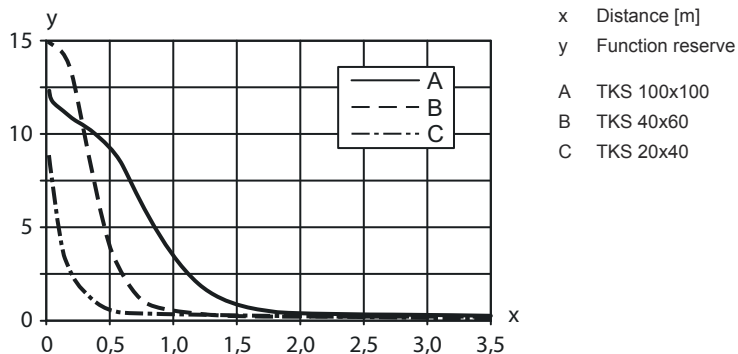



Typ. function reserve



Operation and display

LED	Display	Meaning
1	Green, continuous light	Operational readiness
2	Yellow, continuous light	Light path free

Reflectors & reflective tapes

	Part no.	Designation	Operating range Operating range limit	Description
	50136824	MTKS 12x20M.5	0 ... 0.7 m 0 ... 0.8 m	Design: Rectangular Triple reflector size: 0.3 mm Reflective surface: 12 mm x 20 mm Material: Plastic Base material: Stainless steel Fastening: Through-hole mounting Compatibility of materials: Alcohol, CleanProof+, ECOLAB, H2O2
	50106961	MTKS 14x23.P	0 ... 0.25 m 0 ... 0.3 m	Design: Rectangular Triple reflector size: 12 mm Reflective surface: 11 mm x 21 mm Material: Plastic Base material: Plastic Chemical designation of the material: PES Fastening: Through-hole mounting, Adhesive Compatibility of materials: ECOLAB
	50117583	MTKS 50x50.1	0 ... 1.3 m 0 ... 1.6 m	Design: Rectangular Triple reflector size: 1.2 mm Reflective surface: 50 mm x 50 mm Material: Plastic Base material: Plastic Chemical designation of the material: PMMA8N Fastening: Through-hole mounting, Adhesive
	50136823	MTKS 7x7M.5	0 ... 0.4 m 0 ... 0.5 m	Design: Rectangular Triple reflector size: 0.3 mm Reflective surface: 7 mm x 7 mm Material: Plastic Base material: Stainless steel Fastening: Through-hole mounting Compatibility of materials: Alcohol, CleanProof+, ECOLAB, H2O2
	50110192	REF 6-A-50x50	0 ... 1.2 m 0 ... 1.4 m	Design: Rectangular Triple reflector size: 0.3 mm Reflective surface: 50 mm x 50 mm Material: Plastic Chemical designation of the material: PMMA Fastening: Self-adhesive
	50116939	TK 10.P	0 ... 0.2 m 0 ... 0.25 m	Design: Round Triple reflector size: 1.5 mm Reflective surface, diameter: 8.5 mm Material: Plastic Base material: Plastic Chemical designation of the material: PES Fastening: Rear side can be glued Compatibility of materials: ECOLAB
	50003192	TK 100x100	0 ... 3 m 0 ... 3.6 m	Design: Rectangular Triple reflector size: 4 mm Reflective surface: 96 mm x 96 mm Material: Plastic Base material: Plastic Chemical designation of the material: PMMA8N Fastening: Rear side can be glued

Reflectors & reflective tapes

	Part no.	Designation	Operating range Operating range limit	Description
	50112142	TK BR 53	0 ... 1 m 0 ... 1.2 m	Design: Rectangular Triple reflector size: 0.3 mm Reflective surface: 29 mm x 10 mm Material: Plastic Base material: Stainless steel Chemical designation of the material: Stainless steel Fastening: Housing fit
	50022816	TKS 100X100	0 ... 3 m 0 ... 3.6 m	Design: Rectangular Triple reflector size: 4 mm Reflective surface: 96 mm x 96 mm Material: Plastic Base material: Plastic Chemical designation of the material: PMMA8N Fastening: Through-hole mounting, Adhesive
	50106958	TKS 20.P	0 ... 0.5 m 0 ... 0.6 m	Design: Round Triple reflector size: 2.3 mm Reflective surface, diameter: 17 mm Material: Plastic Base material: Plastic Chemical designation of the material: PES Fastening: M4 threaded pin Compatibility of materials: ECOLAB
	50081283	TKS 20X40	0 ... 1 m 0 ... 1.2 m	Design: Rectangular Triple reflector size: 2.3 mm Reflective surface: 16 mm x 38 mm Material: Plastic Base material: Plastic Chemical designation of the material: PMMA8N Fastening: Through-hole mounting, Adhesive
	50106960	TKS 20x40.P	0 ... 0.7 m 0 ... 0.8 m	Design: Rectangular Triple reflector size: 2.3 mm Reflective surface: 16 mm x 38 mm Material: Plastic Base material: Plastic Chemical designation of the material: PES Fastening: Through-hole mounting, Adhesive Compatibility of materials: ECOLAB
	50040820	TKS 40X60	0 ... 2 m 0 ... 2.4 m	Design: Rectangular Triple reflector size: 4 mm Reflective surface: 37 mm x 56 mm Material: Plastic Base material: Plastic Chemical designation of the material: PMMA8N Fastening: Through-hole mounting, Adhesive
	50120538	TKS 40x60.1.AF	0 ... 1.8 m 0 ... 2.2 m	Special version: Anti-fog coating Design: Rectangular Triple reflector size: 2.3 mm Reflective surface: 37 mm x 56 mm Material: Plastic Base material: Plastic Chemical designation of the material: PMMA8N Fastening: Through-hole mounting, Adhesive
	50136383	TKS 40x60.Chem	0 ... 1.2 m 0 ... 1.4 m	Design: Rectangular Triple reflector size: 4 mm Reflective surface: 37 mm x 56 mm Material: Plastic Base material: Plastic Chemical designation of the material: PET Fastening: Through-hole mounting, Adhesive Compatibility of materials: Alcohol, ECOLAB, H2O2

Reflectors & reflective tapes

	Part no.	Designation	Operating range Operating range limit	Description
	50106957	TKS 40x60.P	0 ... 1.2 m 0 ... 1.4 m	Design: Rectangular Triple reflector size: 4 mm Reflective surface: 37 mm x 56 mm Material: Plastic Base material: Plastic Chemical designation of the material: PES Fastening: Through-hole mounting, Adhesive Compatibility of materials: ECOLAB

Part number code

Part designation: **AAA53C d EE-f.GGGG H/i J-K.LL**

AAA53C	Operating principle / construction HT53C: Diffuse reflection sensor with background suppression LS53C: Throughbeam photoelectric sensor transmitter LE53C: Throughbeam photoelectric sensor receiver PRK53C: Retro-reflective photoelectric sensor with polarization filter ODT53C: Distance diffuse sensor with background suppression
d	Light type n/a: red light I: infrared light
EE	Light source n/a: LED L1: laser class 1 L2: laser class 2
f	Preset range (optional) n/a: operating range acc. to data sheet xxxF: Preset range [mm]
GGGG	Equipment n/a: standard A: Autocollimation principle (single lens) for positioning tasks F: Permanently set range H2O: Detection of aqueous liquids Fill-level monitoring S: small light spot T: autocollimation principle (single lens) for highly transparent bottles without tracking TT: autocollimation principle (single lens) for highly transparent bottles with tracking V: V-optics XL: Extra long light spot X: extended model
H	Operating range adjustment n/a with HT: range adjustable via 8-turn potentiometer n/a with retro-reflective photoelectric sensors (PRK): operating range not adjustable 1: 270° potentiometer 3: teach-in via button
i	Switching output/function OUT 1/IN: Pin 4 or black conductor 2: NPN transistor output, light switching N: NPN transistor output, dark switching 4: PNP transistor output, light switching P: PNP transistor output, dark switching 6: push-pull switching output, PNP light switching, NPN dark switching G: Push-pull switching output, PNP dark switching, NPN light switching L: IO-Link interface (SIO mode: PNP light switching, NPN dark switching) 8: activation input (activation with high signal) X: pin not used 1: IO-Link / light switching (NPN) / dark switching (PNP) 7: Input for sensitivity adjustment

Part number code

J	Switching output / function OUT 2/IN: pin 2 or white conductor 2: NPN transistor output, light switching N: NPN transistor output, dark switching 4: PNP transistor output, light switching P: PNP transistor output, dark switching 6: push-pull switching output, PNP light switching, NPN dark switching G: Push-pull switching output, PNP dark switching, NPN light switching T: teach-in via cable X: pin not used 8: activation input (activation with high signal) 9: deactivation input (deactivation with high signal)
K	Electrical connection M8: M8 connector, 4-pin (plug)
LL	Parameterization P1: different configuration

Note

	<p>↪ A list with all available device types can be found on the Leuze website at www.leuze.com.</p>
--	--

Notes



Observe intended use!

	<p>↪ This product is not a safety sensor and is not intended as personnel protection.</p> <p>↪ The product may only be put into operation by competent persons.</p> <p>↪ Only use the product in accordance with its intended use.</p>
--	--

For UL applications:

	<p>↪ For UL applications, use is only permitted in Class 2 circuits in accordance with the NEC (National Electric Code).</p> <p>↪ These proximity switches shall be used with UL Listed Cable assemblies rated 30V, 0.5A min, in the field installation, or equivalent (categories: CYJV/ CYJV7 or PVVA/PVVA7)</p>
--	--

Further information



- Light source: Average life expectancy 100,000h at an ambient temperature of 25 °C
- Response time: For short decay times, an ohmic load of approx. 5kOhm is recommended
- Sum of the output currents for both outputs, 50 mA for ambient temperatures > 40 °C
- Permissible operating temperature range during IO-Link operation: -10 °C to +60 °C
- Use of micro-triad-type reflectors beginning with MTK(S) or REF 6-A- reflective tape is preferred.
- For REF 6-A- reflective tape, the sensor's side edge must be aligned parallel to the side edge of the reflective tape.
- The light spot may not exceed the reflector.
- IP 69K only with internal tube installation of M8 connector
- Ambient temperature, operation: +70 °C permissible only briefly (≤ 15min)

Accessories

Connection technology - Connection unit

	Part no.	Designation	Article	Description
	50144900	MD 798i-11-82/L5-2222	IO-Link master	Current consumption, max.: 11,000 mA Interface: IO-Link, Automatic protocol detection, EtherNet IP, Modbus TCP, PROFINET Connections: 12 Piece(s) Sensor connections: 8 Piece(s) Degree of protection: IP 67, IP 65, IP 69K

Connection technology - Connection cables

	Part no.	Designation	Article	Description
	50148347	KD U-M8-4A-T0-050 F+B	Connection cable	Application: Chemical resistant, Hygienic and wet areas Connection 1: Connector, M8, Axial, Female, A-coded, 4 -pin Connector, LED: No Connection 2: Open end Shielded: No Cable length: 5,000 mm Sheathing material: TPE
	50130850	KD U-M8-4A-V1-050	Connection cable	Application: Chemical resistant Connection 1: Connector, M8, Axial, Female, 4 -pin Connector, LED: No Connection 2: Open end Shielded: No Cable length: 5,000 mm Sheathing material: PVC

Mounting technology - Other

	Part no.	Designation	Article	Description
	50145361	BTU 053M.5F-D12-T	Mounting system	Design of mounting device: Mounting system Fastening, at system: Screw type Mounting bracket, at device: For 12 mm rod Type of mounting device: Turning, 360°, Adjustable Material: Stainless steel

Note



A list with all available accessories can be found on the Leuze website in the Download tab of the article detailed page.