

## Technical data sheet

### Bar code positioning system

Part no.: 50137879

BPS 8 SM 102-10



For illustration purposes only

#### Contents

- Technical data
- Dimensioned drawings
- Electrical connection
- Diagrams
- Operation and display
- Part number code
- Notes
- Accessories



CDRH



## Technical data

### Basic data

Series	BPS 8
Data telegram	Binary protocol 6
Order guide	Bar code tape must be ordered separately

### Characteristic parameters

MTTF	67.5 years
------	------------

### Optical data

Depth of field	80 ... 140 mm
Light source	Laser, Red
Wavelength	655 nm
Laser class	2, IEC/EN 60825-1:2007
Transmitted-signal shape	Continuous
Light beam exit	Front

### Measurement data

Measurement range	0 ... 10,000,000 mm
Resolution	0.001 ... 100 mm
Measurement value output	3.3 ms
Max. traverse rate	4 m/s

### Electrical data

Protective circuit	Short circuit protected
--------------------	-------------------------

#### Performance data

Supply voltage $U_B$	4.75 ... 5.5 V, DC
Current consumption, max.	250 mA

#### Inputs/outputs selectable

Output current, max.	100 mA
Number of inputs/outputs selectable	1 Piece(s)

### Interface

Type	RS 232
<b>RS 232</b>	
Function	Process
Transmission speed	1,200 ... 187,500 Bd
Data format	Adjustable
Start bit	1
Data bit	8
Stop bit	1
Parity	Adjustable
Transmission protocol	Adjustable
Data encoding	Binary

### Service interface

Type	RS 232
<b>RS 232</b>	
Function	Service

### Connection

Number of connections	1 Piece(s)
-----------------------	------------

### Connection 1

Function	Connection to device
Type of connection	Connector
Thread size	M12
Type	Male
Material	Metal
No. of pins	5 -pin
Encoding	A-coded

### Mechanical data

Design	Cubic
Dimension (W x H x L)	15 mm x 48 mm x 40.3 mm
Housing material	Metal
Metal housing	Diecast zinc
Lens cover material	Glass
Net weight	70 g
Housing color	Red
	Silver
Type of fastening	Dovetail grooves
	Mounting thread
	Through-hole mounting
	Via optional mounting device

### Operation and display

Type of display	LED
Number of LEDs	2 Piece(s)

### Environmental data

Ambient temperature, operation	0 ... 40 °C
Ambient temperature, storage	-20 ... 60 °C
Relative humidity (non-condensing)	0 ... 90 %

### Certifications

Degree of protection	IP 67, EN 60529 with various connectors or screwed-on caps
Protection class	III
Certifications	c UL US
Test procedure for EMC in accordance with standard	EN 55022 EN 55024 EN 61000-4-2, -3, -4, -6 EN 61000-6-2, -3
Test procedure for shock in accordance with standard	EN 60068-2-27 IEC 60068-2-27, test Ea
Test procedure for continuous shock in accordance with standard	IEC 60068-2-29, test Eb
Test procedure for vibration in accordance with standard	IEC 60068-2-6, test Fc

## Technical data

Customs tariff number	84719000
ECLASS 5.1.4	27280190
ECLASS 8.0	27280190
ECLASS 9.0	27280190
ECLASS 10.0	27280190
ECLASS 11.0	27280190
ECLASS 12.0	27280106
ECLASS 13.0	27280106
ECLASS 14.0	27280106
ETIM 5.0	EC001825
ETIM 6.0	EC001825
ETIM 7.0	EC001825
ETIM 8.0	EC001825
ETIM 9.0	EC001825

**Dimensioned drawings**

All dimensions in millimeters

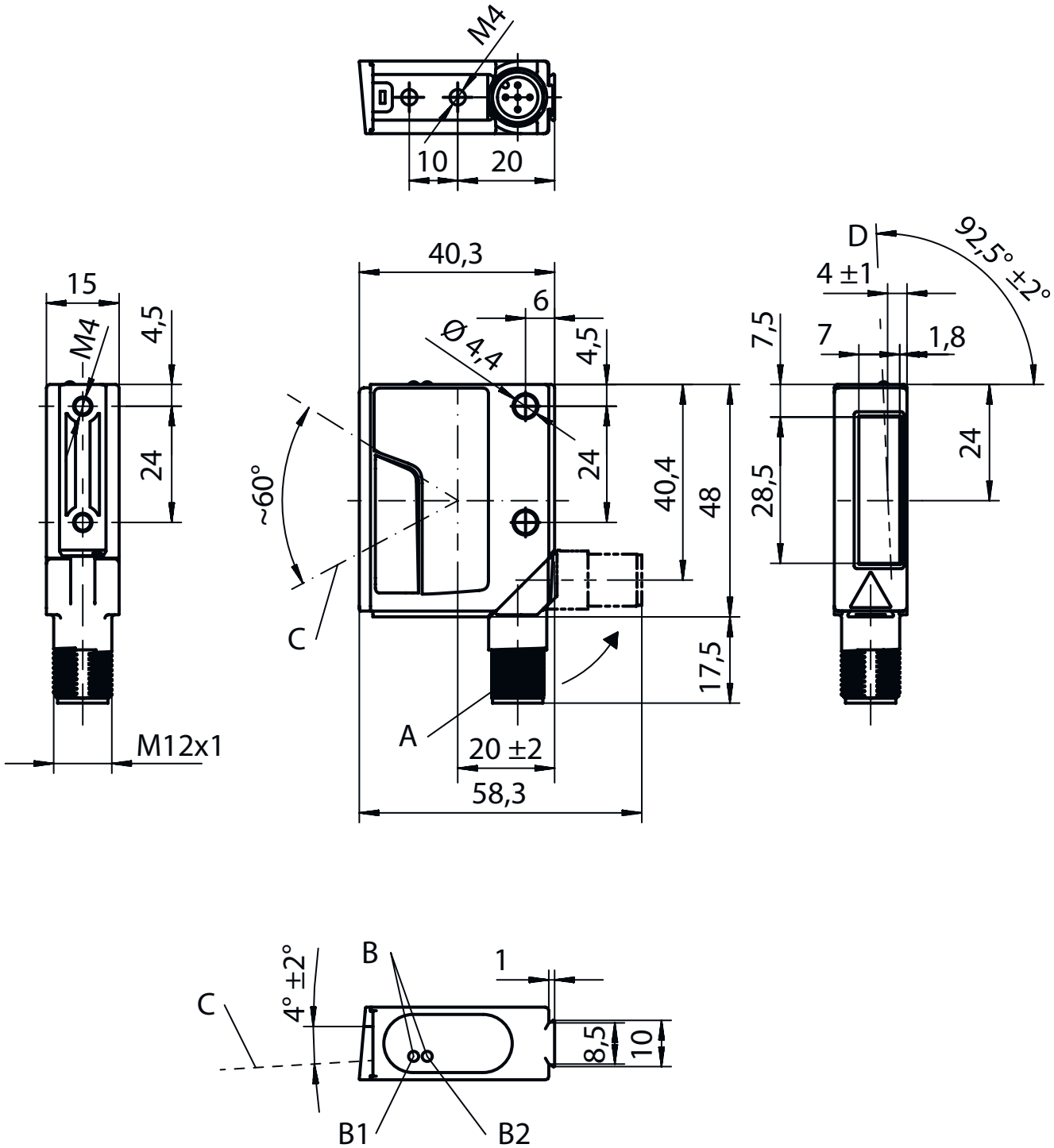

- A Turning connector, turnable by 90°
- B Indicator diodes (B1: status LED, B2: decode LED)
- C Scanning beam, divergence max. 5 mm at 150 mm reading distance
- D Optical axis

# Electrical connection

## Connection 1

Function	Connection to device
Type of connection	Connector
Thread size	M12
Type	Male
Material	Metal
No. of pins	5 -pin
Encoding	A-coded

Pin	Pin assignment
1	V+
2	RS 232 TxD
3	GND
4	RS 232 RxD
5	SW IN/OUT

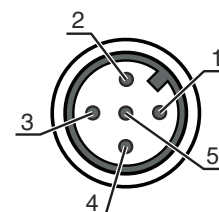

## Diagrams

### Reading field curve

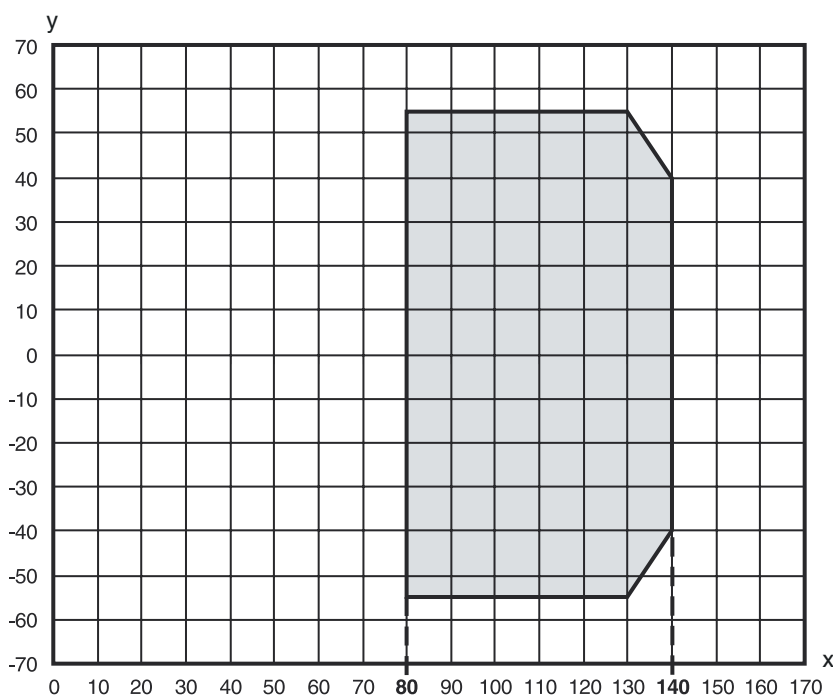

x Reading distance [mm]  
 y Reading field width [mm]  
 Gray Working range

## Operation and display

LED	Display	Meaning
1	Off	No supply voltage
	Green, flashing	Device ok, initialization phase
	Green, continuous light	Operational readiness
	Red, flashing	Device OK, warning set
	Red, continuous light	Device error
	Orange, flashing	Service operation active
2	Off	Positioning deactivated
	Green, continuous light	Positioning running (position value valid)

# Operation and display

LED	Display	Meaning
2	Red, continuous light	Positioning running (position value invalid)
	Orange, continuous light	Positioning running (marker label detected)

## Part number code

Part designation: **BPS 8 XX YYY - ZZ**

<b>XX</b>	<b>Scanning principle / optics</b> S: line scanner (single line) M: Medium Density (medium distance)
<b>YYY</b>	<b>Beam exit</b> 100: lateral 102: front
<b>ZZ</b>	<b>Presetting</b> 01 / 05: Binary protocol 1 02: Binary protocol 2 03: Binary protocol 3 04: Binary protocol 4 10: Binary protocol 6

**Note**



A list with all available device types can be found on the Leuze website at [www.leuze.com](http://www.leuze.com).

## Notes

 **Observe intended use!**



- ⌘ This product is not a safety sensor and is not intended as personnel protection.
- ⌘ The product may only be put into operation by competent persons.
- ⌘ Only use the product in accordance with its intended use.

 **ATTENTION! LASER RADIATION – CLASS 2 LASER PRODUCT**



**Do not stare into beam!**  
The device satisfies the requirements of IEC/EN 60825-1:2014 safety regulations for a product of **laser class 2** as well as the U.S. 21 CFR 1040.10 regulations with deviations corresponding to Laser Notice No. 56 from May 08, 2019.

- ⌘ Never look directly into the laser beam or in the direction of reflected laser beams! If you look into the beam path over a longer time period, there is a risk of injury to the retina.
- ⌘ Do not point the laser beam of the device at persons!
- ⌘ Interrupt the laser beam using a non-transparent, non-reflective object if the laser beam is accidentally directed towards a person.
- ⌘ When mounting and aligning the device, avoid reflections of the laser beam off reflective surfaces!
- ⌘ CAUTION! Use of controls or adjustments or performance of procedures other than specified herein may result in hazardous light exposure.
- ⌘ Observe the applicable statutory and local laser protection regulations.
- ⌘ The device must not be tampered with and must not be changed in any way.  
There are no user-serviceable parts inside the device.  
Repairs must only be performed by Leuze electronic GmbH + Co. KG.

## Notes

### NOTE



#### Affix laser information and warning signs!

Laser information and warning signs are affixed to the device. In addition, self-adhesive laser information and warning signs (stick-on labels) are supplied in several languages.

- ☞ Affix the laser information sheet to the device in the language appropriate for the place of use. When using the device in the US, use the stick-on label with the "Complies with 21 CFR 1040.10" note.
- ☞ Affix the laser information and warning signs near the device if no signs are attached to the device (e.g. because the device is too small) or if the attached laser information and warning signs are concealed due to the installation position.
- ☞ Affix the laser information and warning signs so that they are legible without exposing the reader to the laser radiation of the device or other optical radiation.

## Accessories

### Connection technology - Connection unit

	Part no.	Designation	Article	Description
	50112891	MA 248i Profinet Gateway	Modular connection unit	Supply voltage: 18 ... 30 V Current consumption, max.: 300 mA Interface: PROFINET, RS 232 Connections: 6 Piece(s) Degree of protection: IP 65
	50104790	MA 8-01	Modular connection unit	Supply voltage: 10 ... 30 V Current consumption, max.: 50 mA Interface: RS 485 Connections: 3 Piece(s) Degree of protection: IP 67

### Connection technology - Connection cables

	Part no.	Designation	Article	Description
	50040757	KB 008-3000 A	Connection cable	Connection 1: Connector, M12, Axial, Female, A-coded, 5 -pin Connector, LED: No Connection 2: Open end Shielded: Yes Cable length: 3.000 mm Sheathing material: PUR

### Connection technology - Interconnection cables

	Part no.	Designation	Article	Description
	50113467	KB JST-M12A-5P-3000	Interconnection cable	Suitable for interface: RS 232 Connection 1: Connector, M12, Axial, Female, A-coded, 5 -pin Connection 2: JST ZHR, 12 -pin Shielded: Yes Cable length: 3,000 mm Sheathing material: PUR

## Accessories

	Part no.	Designation	Article	Description
	50133890	KDS S-M12-5A-M12-5A-P1-020	Interconnection cable	Connection 1: Connector, M12, Axial, Female, A-coded, 5 -pin Connection 2: Connector, M12, Axial, Male, A-coded, 5 -pin Shielded: Yes Cable length: 2,000 mm Sheathing material: PUR

## Mounting technology - Mounting brackets

	Part no.	Designation	Article	Description
	50104791	BT 8-01	Mounting device	Fastening, at system: Through-hole mounting Mounting bracket, at device: Screw type Material: Metal

## Mounting technology - Rod mounts

	Part no.	Designation	Article	Description
	50127177	BTU 008M-D10	Mounting system	Design of mounting device: Mounting system Fastening, at system: Sheet-metal mounting, For 10 mm rod Mounting bracket, at device: Screw type Type of mounting device: Turning, 360°, Adjustable, Clampable Material: Metal

## Bar code tape

	Part no.	Designation	Article	Description
	50144173	BCB G30 H25 L010	Bar code tape	Dimensions: 25 mm x 10,000 mm Grid dimension: 30 mm
	50104792	BCB G30 H47 L010	Bar code tape	Dimensions: 47 mm x 10,000 mm Grid dimension: 30 mm

### Note



A list with all available accessories can be found on the Leuze website in the Download tab of the article detailed page.