

## Technical data sheet

### Vision sensor

Part no.: 50146024

IVS 108 M1-102-W0



For illustration purposes only

#### Contents

- Technical data
- Dimensioned drawings
- Electrical connection
- Diagrams
- Notes
- Accessories



Ethernet

## Technical data

### Basic data

Series	IVS 108
--------	---------

### Functions

Software functions	Presence control
--------------------	------------------

### Optical data

Working range	50 ... 150 mm
Light source	LED, White
Camera resolution, horizontal	320 px
Camera resolution, vertical	240 px

### Measurement data

Max. throughput per second	20 pieces per second
Measurement value calculation time	50 ms

### Electrical data

#### Performance data

Supply voltage $U_B$	10 ... 30 V, DC
Average power consumption	4.2 W

#### Inputs

Number of digital switching inputs	2 Piece(s)
------------------------------------	------------

#### Switching inputs

Type	Optical coupler, polarity-independent
Voltage type	DC
Switching current, max.	10 mA
Switching voltage	30 V DC

#### Outputs

Number of digital switching outputs	3 Piece(s)
-------------------------------------	------------

#### Switching outputs

Type	Digital switching output
Switching current, max.	100 mA

#### Switching output 1

Switching element	Transistor, Push-pull
Switching principle	PNP / NPN switchable

#### Switching output 2

Switching element	Transistor, Push-pull
Switching principle	PNP / NPN switchable

#### Switching output 3

Switching element	Transistor, Push-pull
Switching principle	PNP / NPN switchable

### Interface

Type	Ethernet
------	----------

#### Ethernet

Address assignment	DHCP Manual address assignment
Transmission speed	10 Mbit/s 100 Mbit/s
Function	Service
Switch functionality	None
Transmission protocol	TCP/IP

### Connection

Number of connections	2 Piece(s)
-----------------------	------------

#### Connection 1

Function	Signal IN Signal OUT Voltage supply
----------	---

Type of connection	Connector
--------------------	-----------

Thread size	M12
-------------	-----

Type	Male
------	------

Material	Metal
----------	-------

No. of pins	17 -pin
-------------	---------

Encoding	A-coded
----------	---------

#### Connection 2

Function	Configuration interface
----------	-------------------------

Type of connection	Connector
--------------------	-----------

Thread size	M12
-------------	-----

Type	Female
------	--------

Material	Metal
----------	-------

No. of pins	8 -pin
-------------	--------

Encoding	X-coded
----------	---------

### Mechanical data

Design	Cubic
--------	-------

Dimension (W x H x L)	47 mm x 58 mm x 58 mm
-----------------------	-----------------------

Housing material	Metal
------------------	-------

Metal housing	Aluminum
---------------	----------

Lens cover material	Plastic / PMMA
---------------------	----------------

Net weight	173 g
------------	-------

Housing color	Black
---------------	-------

Type of fastening	Mounting thread
-------------------	-----------------

Via optional mounting device

### Operation and display

Type of configuration	Switch Teach-in Via web browser
-----------------------	---------------------------------------

Operational controls	Button(s)
----------------------	-----------

Function of the operational control	Auto-setup Teach-in
-------------------------------------	------------------------

### Environmental data

Ambient temperature, operation	-10 ... 50 °C
--------------------------------	---------------

Ambient temperature, storage	-20 ... 70 °C
------------------------------	---------------

Relative humidity (non-condensing)	90 %
------------------------------------	------

### Certifications

Degree of protection	IP 65
----------------------	-------

IP 67

Approvals	CSA
-----------	-----

## Technical data

Customs tariff number	84719000
ECLASS 5.1.4	27310101
ECLASS 8.0	27310101
ECLASS 9.0	27310201
ECLASS 10.0	27310101
ECLASS 11.0	27310101
ECLASS 12.0	27310101
ECLASS 13.0	27310101
ECLASS 14.0	27310101
ECLASS 15.0	27310101
ECLASS 16.0	27310101
ETIM 5.0	EC002550
ETIM 6.0	EC002550
ETIM 7.0	EC002550
ETIM 8.0	EC002550
ETIM 9.0	EC002550
ETIM 10.0	EC002550
UNSPSC 26.08	43211718

# Dimensioned drawings

All dimensions in millimeters

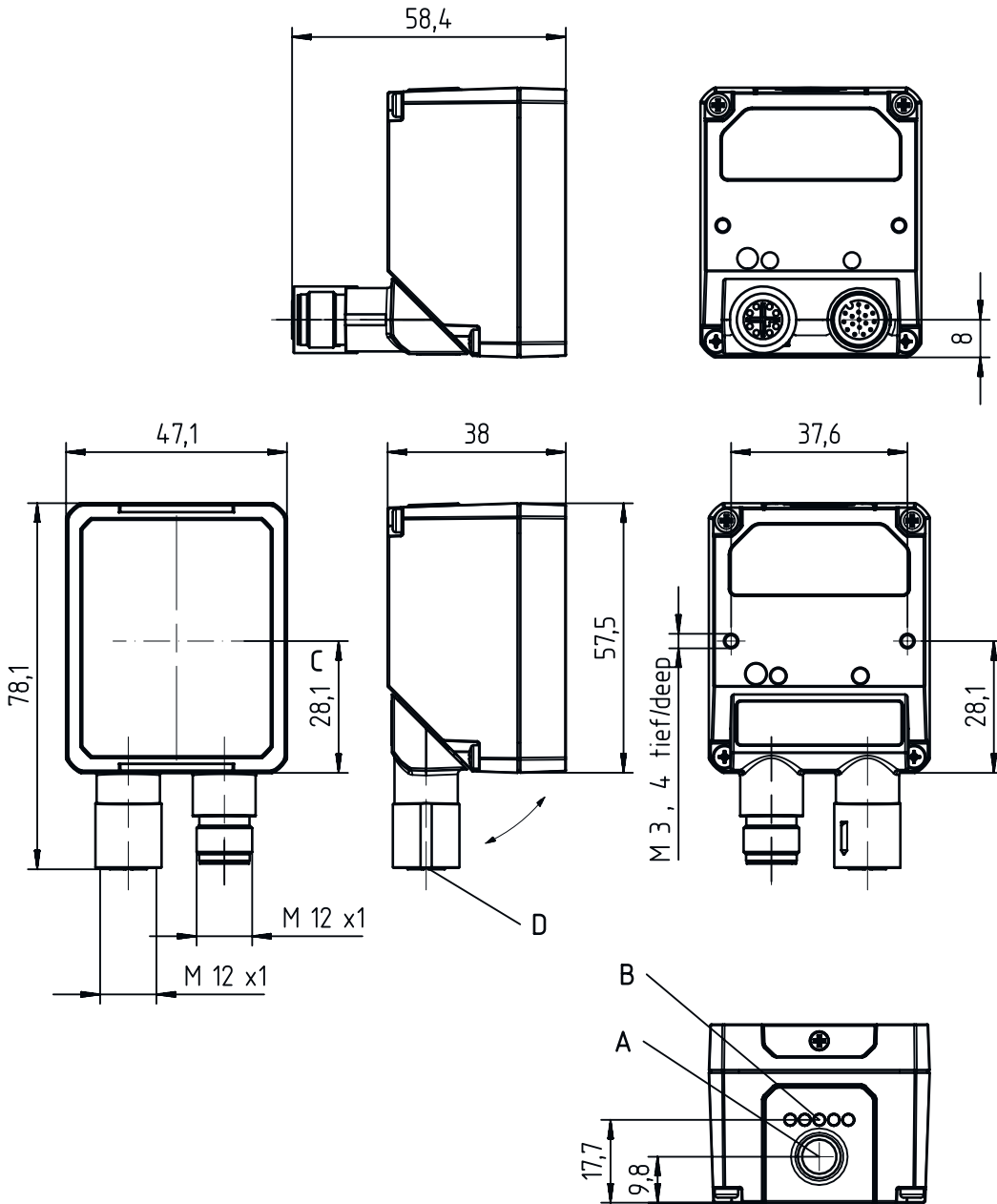

- A Teach-in button
- B LED indicator
- C Optical axis
- D Connection

# Electrical connection

## Connection 1

Function	Signal IN Signal OUT Voltage supply
Type of connection	Connector
Thread size	M12
Type	Male
Material	Metal
No. of pins	17 -pin
Encoding	A-coded

Pin	Pin assignment	Conductor color
1	V+	Brown
2	GND	Blue
3	I2B	White
4	n.c.	-
5	I1B	Pink
6	I1A	Yellow
7	n.c.	-
8	O2	Gray
9	O1	Red
10	n.c.	-
11	n.c.	-
12	n.c.	-
13	I2A	white / green
14	n.c.	-
15	n.c.	-
16	O3	yellow / brown
17	n.c.	-

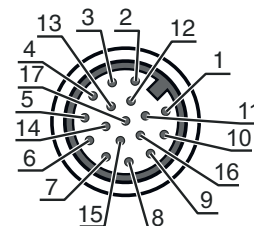

## Connection 2

Function	Configuration interface
Type of connection	Connector
Thread size	M12
Type	Female
Material	Metal
No. of pins	8 -pin
Encoding	X-coded

Pin	Pin assignment
1	Tx+
2	Tx-
3	Rx+
4	Rx-
5	n.c.
6	n.c.
7	n.c.
8	n.c.

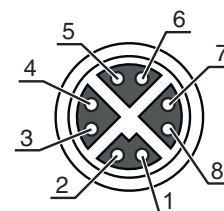

# Diagrams

## Inspection area

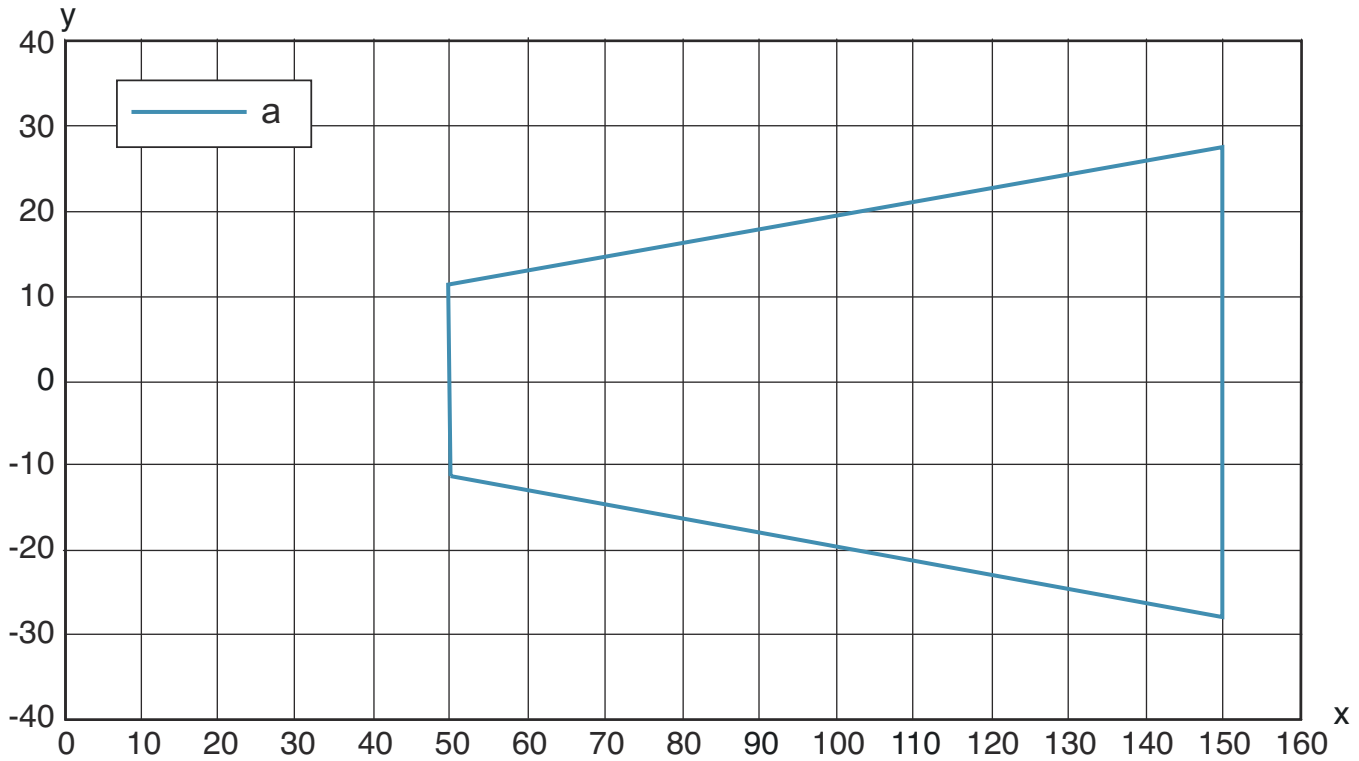

- x Inspection distance
- y Horizontal field of view [mm]
- a Inspection area

## Notes

	<b>Observe intended use!</b>
	<ul style="list-style-type: none"> <li>⌘ This product is not a safety sensor and is not intended as personnel protection.</li> <li>⌘ The product may only be put into operation by competent persons.</li> <li>⌘ Only use the product in accordance with its intended use.</li> </ul>

## Accessories





### Connection technology - Connection cables

	Part no.	Designation	Article	Description
	50146481	KD U-M12-HA-P1-030	Connection cable	Application: Oil and lubricant resistant Connection 1: Connector, M12, Female, A-coded, 17 -pin Connector, LED: No Connection 2: Open end Shielded: No Cable length: 3,000 mm Sheathing material: PUR

## Accessories

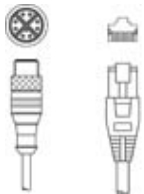
	Part no.	Designation	Article	Description
	50146482	KD U-M12-HA-P1-050	Connection cable	Application: Oil and lubricant resistant Connection 1: Connector, M12, Female, A-coded, 17 -pin Connector, LED: No Connection 2: Open end Shielded: No Cable length: 5,000 mm Sheathing material: PUR

## Connection technology - Interconnection cables

	Part no.	Designation	Article	Description
	50133386	KSS GB-M12-8A-RJ45-A-P7-020	Interconnection cable	Suitable for interface: Ethernet Connection 1: Connector, M12, Axial, Male, X-coded, 8 -pin Connection 2: RJ45 Shielded: Yes Cable length: 2,000 mm Sheathing material: PUR
	50137380	KSS GB-M12-8A-RJ45-A-P7-050	Interconnection cable	Suitable for interface: Ethernet Connection 1: Connector, M12, Axial, Male, X-coded, 8 -pin Connection 2: RJ45 Shielded: Yes Cable length: 5,000 mm Sheathing material: PUR
	50133388	KSS GB-M12-8A-RJ45-A-P7-100	Interconnection cable	Suitable for interface: Ethernet Connection 1: Connector, M12, Axial, Male, X-coded, 8 -pin Connection 2: RJ45 Shielded: Yes Cable length: 10,000 mm Sheathing material: PUR
	50136187	KSS GB-M12-8W-RJ45-A-P7-020	Interconnection cable	Application: Oil and lubricant resistant Suitable for interface: Ethernet Connection 1: Connector, M12, Angled, Male, X-coded, 8 -pin Connection 2: RJ45 Shielded: Yes Cable length: 2,000 mm Sheathing material: PUR
	50136188	KSS GB-M12-8W-RJ45-A-P7-050	Interconnection cable	Application: Oil and lubricant resistant Suitable for interface: Ethernet Connection 1: Connector, M12, Angled, Male, X-coded, 8 -pin Connection 2: RJ45 Shielded: Yes Cable length: 5,000 mm Sheathing material: PUR
	50136189	KSS GB-M12-8W-RJ45-A-P7-100	Interconnection cable	Application: Oil and lubricant resistant Suitable for interface: Ethernet Connection 1: Connector, M12, Angled, Male, X-coded, 8 -pin Connection 2: RJ45 Shielded: Yes Cable length: 10,000 mm Sheathing material: PUR

## Accessories

### Mounting technology - Mounting brackets

	Part no.	Designation	Article	Description
	50118542	BT 200M.5	Mounting bracket	Design of mounting device: Angle, L-shape Fastening, at system: Through-hole mounting Mounting bracket, at device: Screw type, Suited for M3 screws Type of mounting device: Adjustable Material: Stainless steel

### Mounting technology - Other

	Part no.	Designation	Article	Description
	50146204	BTU 0110M-D12	Mounting device	Contains: 2x M3 x 6 screw Design of mounting device: Mounting system Fastening, at system: For 12 mm rod Mounting bracket, at device: Screw type Type of mounting device: Turning, 360°, Adjustable, Clampable Material: Metal

#### Note



A list with all available accessories can be found on the Leuze website in the Download tab of the article detailed page.