

Technical data sheet

Device column

Part no.: 549623

DC-1600-S2

Contents

- Technical data
- Dimensioned drawings
- Accessories



For illustration purposes only

Technical data

Basic data

Series	DC
Contains	BT-P40 clamp bracket, 2x
Suitable for	MLC 500, MLC 300 safety light curtains MLD 500, MLD 300 multiple light beam safety devices
Type, columns and mirrors	Device column

Functions

Functions	Adjustable, 2 directions Mounting and protection of light curtains and multiple light beam devices
-----------	---

Mechanical data

Dimension (W x H x L)	134 mm x 1,600 mm x 134 mm
Housing material	Metal Plastic
Metal housing	Aluminum
Net weight	4,775 g
Housing color	Yellow, RAL 1021
Type of fastening	Mounting plate
Mechanical reset function	No
Column height without foot	1,600 mm
Exterior mounting of accessories	Lateral Rear

Classification

Customs tariff number	76042990
ECLASS 5.1.4	27279290
ECLASS 8.0	27279290
ECLASS 9.0	27279090
ECLASS 10.0	27273792
ECLASS 11.0	27273792
ECLASS 12.0	27273792
ECLASS 13.0	27273792
ECLASS 14.0	27273792
ECLASS 15.0	27273792
ECLASS 16.0	27273792
ETIM 5.0	EC002498
ETIM 6.0	EC003015
ETIM 7.0	EC003015
ETIM 8.0	EC003015
ETIM 9.0	EC003015
ETIM 10.0	EC003015
UNSPSC 26.08	31242100

Dimensioned drawings

All dimensions in millimeters

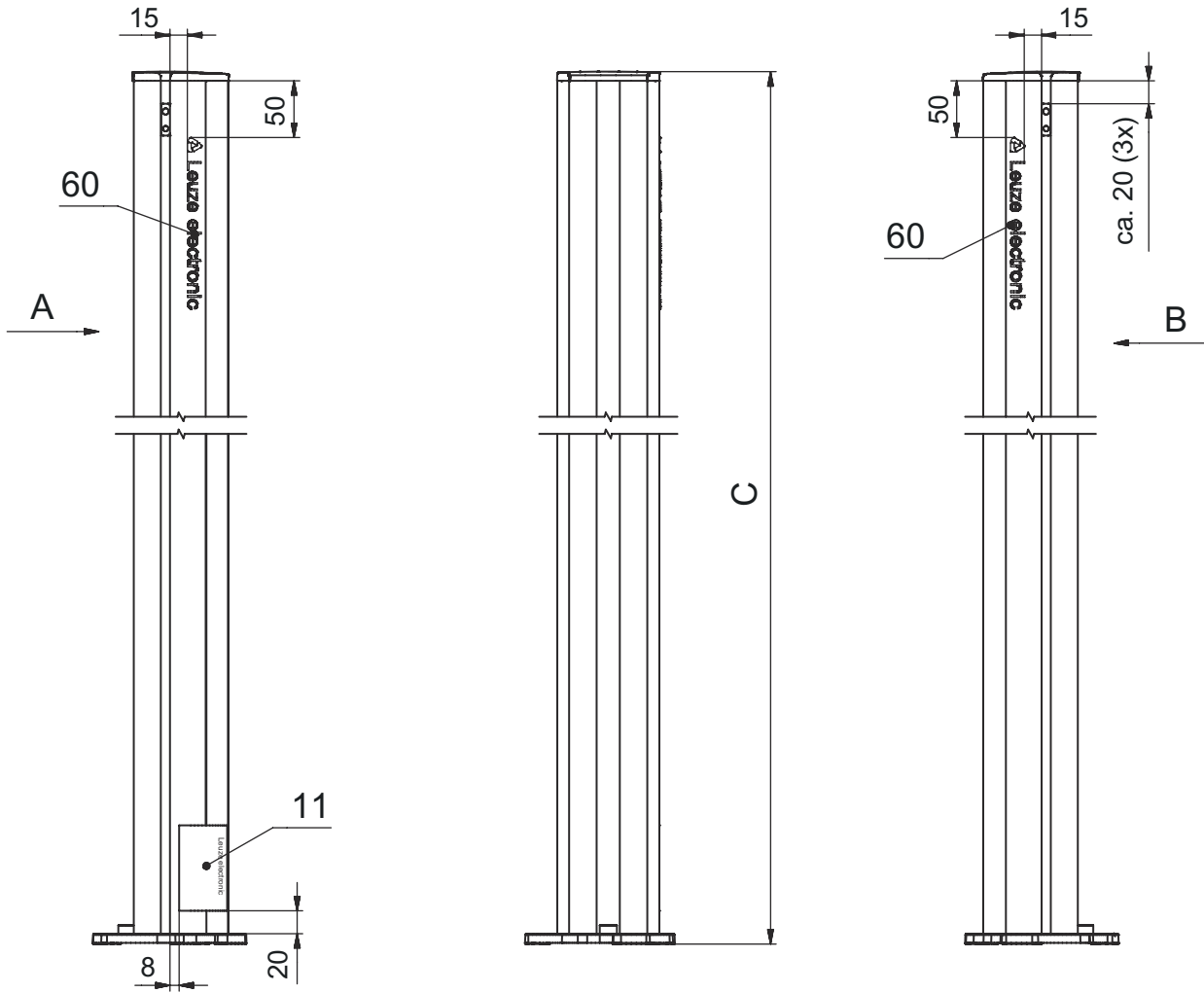

- A Front
- B Front
- C Total height = 1600 mm

84 L Total height = 1600 mm

Accessories

General

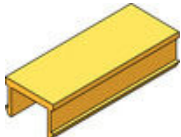
	Part no.	Designation	Article	Description
	50144378	SET 10x AC-UDC-2000	Profile	Contains: 10x Suitable for: UDC-S2, DC-S2 device columns Dimensions: 2,000 mm Color: Yellow Material: PVC

Replacement part

	Part no.	Designation	Article	Description
	430220	SP-SET AP UDC/DC/UMC/MC	Device and mirror column accessory set	Type of article: Adapter plate Housing color: Black

Note



A list with all available accessories can be found on the Leuze website in the Download tab of the article detailed page.