

## Technical data sheet

### Diffuse sensor with background suppression

Part no.: 50154110

HT25CI-100F/2X-M12.Y1



For illustration purposes only

#### Contents

- Technical data
- Dimensioned drawings
- Electrical connection
- Diagrams
- Operation and display
- Part number code
- Notes
- Further information
- Accessories



## Technical data

### Basic data

|                     |  |
|---------------------|--|
| Series              | 25C  |
| Operating principle | Diffuse reflection principle with background suppression |

### Special version

|                 |   |
|-----------------|---|
| Special version | Increased resistance to UV radiation<br>Permanently set range |
|-----------------|---|

### Optical data

|                            |                                       |
|----------------------------|---------------------------------------|
| Black-white error          | < 10% up to 100 mm                    |
| Operating range            | Guaranteed operating range            |
| Operating range, white 90% | 0 ... 0.1 m                           |
| Operating range, black 6%  | 0.005 ... 0.1 m                       |
| Operating range limit      | 0 ... 0.1 m (typical operating range) |
| Light source               | LED, Infrared                         |
| Wavelength                 | 850 nm                                |
| Transmitted-signal shape   | Pulsed                                |
| LED group                  | Exempt group (in acc. with EN 62471)  |

### Electrical data

|                    |   |
|--------------------|---|
| Protective circuit | Polarity reversal protection<br>Short circuit protected |
|--------------------|---|

### Performance data

|                      |  |
|----------------------|--|
| Supply voltage $U_B$ | 10 ... 30 V, DC, Incl. residual ripple |
| Residual ripple      | 0 ... 15 %, From $U_B$                 |
| Open-circuit current | 0 ... 20 mA                            |

### Outputs

|                                     |            |
|-------------------------------------|------------|
| Number of digital switching outputs | 1 Piece(s) |
|-------------------------------------|------------|

### Switching outputs

|                         |   |
|-------------------------|---|
| Type                    | Digital switching output                      |
| Voltage type            | DC  |
| Switching current, max. | 100 mA  |
| Switching voltage       | high: $\geq(U_B - 2.5V)$<br>low: $\leq 2.5 V$ |

### Switching output 1

|                     |                     |
|---------------------|---------------------|
| Assignment          | Connection 1, pin 4 |
| Switching element   | Transistor, NPN     |
| Switching principle | Light switching     |

### Time behavior

|                     |          |
|---------------------|----------|
| Switching frequency | 1,000 Hz |
| Response time       | 0.33 ms  |
| Readiness delay     | 300 ms   |

### Connection

|                       |            |
|-----------------------|------------|
| Number of connections | 1 Piece(s) |
|-----------------------|------------|

### Connection 1

|                    |                              |
|--------------------|------------------------------|
| Function           | Signal OUT<br>Voltage supply |
| Type of connection | Connector                    |
| Thread size        | M12                          |
| Type               | Male                         |
| Material           | PUR                          |
| No. of pins        | 4 -pin                       |
| Encoding           | A-coded                      |

### Mechanical data

|  |  |
|--|--|
| Dimension (W x H x L)                          | 15 mm x 42.7 mm x 30 mm  |
| Housing material                               | Plastic  |
| Plastic housing                                | ABS  |
| Lens cover material                            | Plastic  |
| Net weight                                     | 55 g   |
| Housing color                                  | Red  |
| Type of fastening                              | Through-hole mounting with M4 thread<br>Via optional mounting device |
| Recommended tightening torque for M3 fastening | 0.9 N·m  |
| Recommended tightening torque for M4 fastening | 1.4 N·m  |
| Compatibility of materials                     | ECOLAB   |

### Operation and display

|                 |            |
|-----------------|------------|
| Type of display | LED        |
| Number of LEDs  | 2 Piece(s) |

### Environmental data

|                                |               |
|--------------------------------|---------------|
| Ambient temperature, operation | -40 ... 60 °C |
| Ambient temperature, storage   | -40 ... 70 °C |

### Certifications

|                      |                 |
|----------------------|-----------------|
| Degree of protection | IP 67<br>IP 69K |
| Protection class     | III             |
| Approvals            | c UL US         |
| Standards applied    | IEC 60947-5-2   |

### Classification

|                       |          |
|-----------------------|----------|
| Customs tariff number | 85365019 |
| ECLASS 5.1.4          | 27270904 |
| ECLASS 8.0            | 27270904 |
| ECLASS 9.0            | 27270904 |
| ECLASS 10.0           | 27270904 |
| ECLASS 11.0           | 27270904 |
| ECLASS 12.0           | 27270903 |
| ECLASS 13.0           | 27270903 |
| ECLASS 14.0           | 27270903 |
| ECLASS 15.0           | 27270903 |
| ECLASS 16.0           | 27270903 |
| ETIM 5.0              | EC002719 |
| ETIM 6.0              | EC002719 |
| ETIM 7.0              | EC002719 |
| ETIM 8.0              | EC001821 |
| ETIM 9.0              | EC001821 |
| ETIM 10.0             | EC001821 |
| UNSPSC 26.08          | 39121528 |

# Dimensioned drawings

All dimensions in millimeters

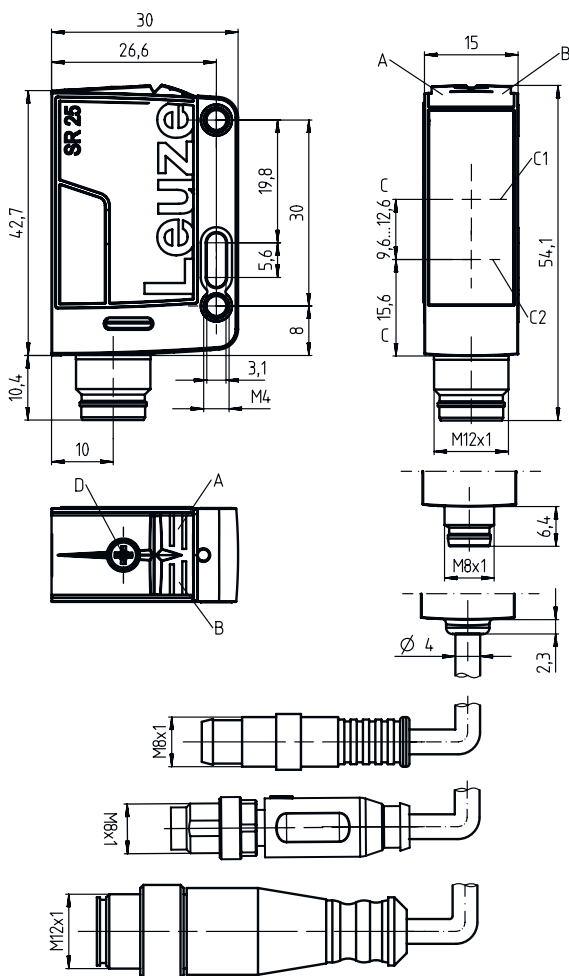

- A Green LED
- B Yellow LED
- C Optical axis
- C1 Receiver
- C2 Transmitter
- D Range adjustment

## Electrical connection

### Connection 1

|                    |                |
|--------------------|----------------|
| Function           | Signal OUT     |
|                    | Voltage supply |
| Type of connection | Connector      |
| Thread size        | M12            |
| Type               | Male           |
| Material           | PUR            |
| No. of pins        | 4 -pin         |
| Encoding           | A-coded        |

| Pin | Pin assignment | Conductor color |
|-----|----------------|-----------------|
| 1   | V+             | Brown           |
| 2   | n.c.           | White           |
| 3   | GND            | Blue            |
| 4   | OUT 1          | Black           |

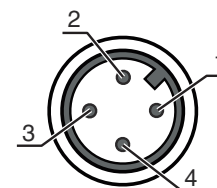

**Diagrams**

Typ. response behavior (focusing distance 500 mm)

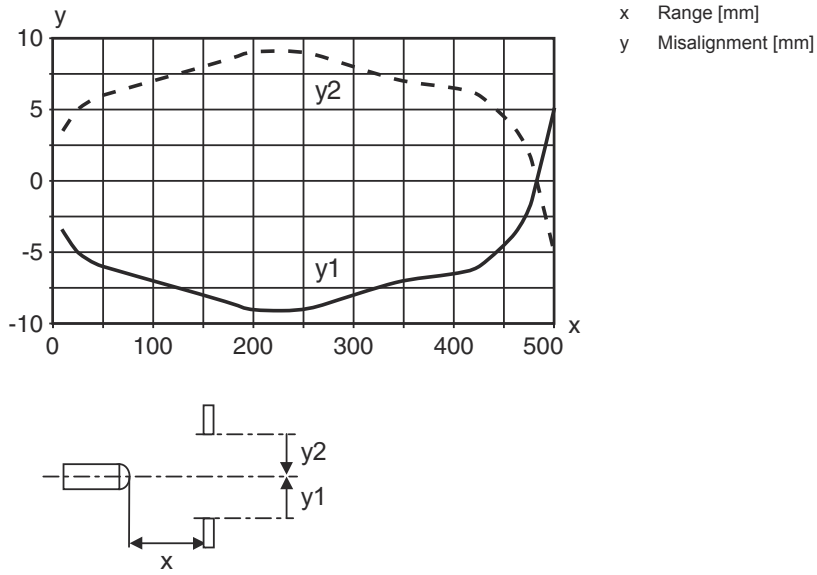

Typ. response behavior (focusing distance 1300 mm)

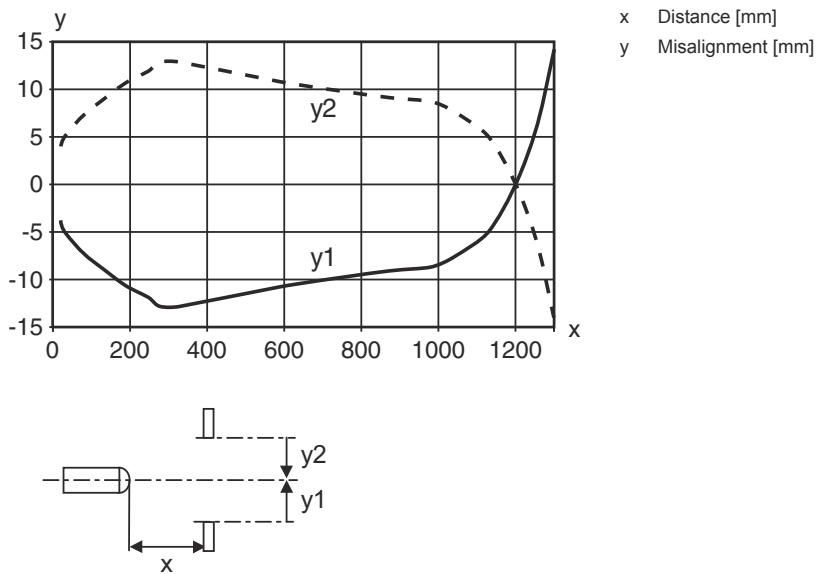

# Diagrams

## Typ. black/white behavior

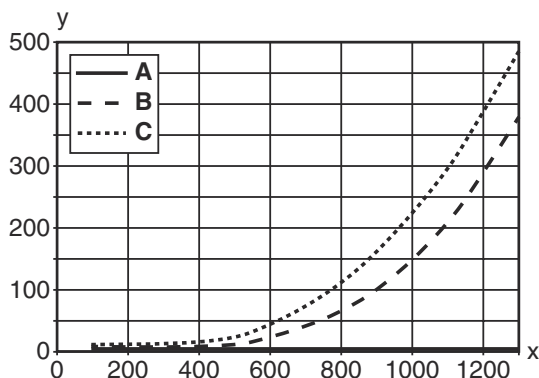

x Range [mm]  
 y Reduction of range [mm]  
 A White 90%  
 B Gray 18%  
 C Black 6%



## Operation and display

| LED | Display                  | Meaning               |
|-----|--------------------------|-----------------------|
| 1   | Green, continuous light  | Operational readiness |
| 2   | Yellow, continuous light | Object detected       |

## Part number code

Part designation: **AAA25C d EE-f.GGH/IJ-K**

|               |   |
|---------------|---|
| <b>AAA25C</b> | <b>Operating principle / construction</b><br>HT25C: Diffuse reflection sensor with background suppression<br>PRK25C: Retro-reflective photoelectric sensor with polarization filter<br>LS25C: Throughbeam photoelectric sensor transmitter<br>LE25C: Throughbeam photoelectric sensor receiver<br>DRT25C: Dynamic reference diffuse sensor  |
| <b>d</b>      | <b>Light type</b><br>n/a: red light<br>I: infrared light  |
| <b>EE</b>     | <b>Light source</b><br>n/a: LED<br>PP: Power PinPoint® LED<br>L1: laser class 1<br>L2: laser class 2  |
| <b>f</b>      | <b>Preset range (optional)</b><br>n/a: operating range acc. to data sheet<br>xxxF: Preset range [mm]  |
| <b>GG</b>     | <b>Equipment</b><br>A: Autocollimation principle (single lens)<br>S: small light spot<br>D: Detection of stretch-wrapped objects<br>X: extended model<br>HF: Suppression of HF illumination (LED)<br>XL: Extra long light spot<br>T: autocollimation principle (single lens) for highly transparent bottles without tracking<br>TT: autocollimation principle (single lens) for highly transparent bottles with tracking<br>F: Foreground suppression<br>R: greater operating range<br>SL: Slit diaphragm |

## Part number code

|          |   |
|----------|---|
| <b>H</b> | <b>Operating range adjustment</b><br>1: 270° potentiometer<br>2: multiturn potentiometer<br>3: teach-in via button<br>R: greater operating range  |
| <b>i</b> | <b>Switching output/function OUT 1/IN: Pin 4 or black conductor</b><br>2: NPN transistor output, light switching<br>N: NPN transistor output, dark switching<br>4: PNP transistor output, light switching<br>P: PNP transistor output, dark switching<br>X: pin not used<br>8: activation input (activation with high signal)<br>L: IO-Link interface (SIO mode: PNP light switching, NPN dark switching)<br>6: push-pull switching output, PNP light switching, NPN dark switching<br>G: Push-pull switching output, PNP dark switching, NPN light switching |
| <b>J</b> | <b>Switching output / function OUT 2/IN: pin 2 or white conductor</b><br>2: NPN transistor output, light switching<br>N: NPN transistor output, dark switching<br>4: PNP transistor output, light switching<br>P: PNP transistor output, dark switching<br>W: warning output<br>X: pin not used<br>6: push-pull switching output, PNP light switching, NPN dark switching<br>T: teach-in via cable<br>G: Push-pull switching output, PNP dark switching, NPN light switching<br>8: activation input (activation with high signal)                             |
| <b>K</b> | <b>Electrical connection</b><br>n/a: cable, standard length 2000 mm, 4-wire<br>200-M12: cable, length 200 mm with M12 connector, 4-pin, axial (plug)<br>M8: M8 connector, 4-pin (plug)<br>M12: M12 connector, 4-pin (plug)<br>200-M8: cable, length 200 mm with M8 connector, 4-pin, axial (plug)<br>M8.1: Snap-in, M8 connector, 4-pin (plug)  |

### Note



A list with all available device types can be found on the Leuze website at [www.leuze.com](http://www.leuze.com).

## Notes



### Observe intended use!



- ⌘ This product is not a safety sensor and is not intended as personnel protection.
- ⌘ The product may only be put into operation by competent persons.
- ⌘ Only use the product in accordance with its intended use.

## Further information

- Light source: Average life expectancy 100,000 h at an ambient temperature of 25 °C
- Sum of the output currents for both outputs 100 mA

## Accessories

### Connection technology - Connection cables

|   | Part no. | Designation        | Article          | Description   |
|---|----------|--------------------|------------------|---|
|  | 50130652 | KD U-M12-4A-V1-050 | Connection cable | Application: Chemical resistant<br>Connection 1: Connector, M12, Axial, Female, A-coded, 4 -pin<br>Connector, LED: No<br>Connection 2: Open end<br>Shielded: No<br>Cable length: 5,000 mm<br>Sheathing material: PVC  |
|  | 50130690 | KD U-M12-4W-V1-050 | Connection cable | Application: Chemical resistant<br>Connection 1: Connector, M12, Angled, Female, A-coded, 4 -pin<br>Connector, LED: No<br>Connection 2: Open end<br>Shielded: No<br>Cable length: 5,000 mm<br>Sheathing material: PVC |

### Mounting technology - Mounting brackets

|  | Part no. | Designation | Article          | Description   |
|--|----------|-------------|------------------|---|
|  | 50118543 | BT 300M.5   | Mounting bracket | Design of mounting device: Angle, L-shape<br>Fastening, at system: Through-hole mounting<br>Mounting bracket, at device: Screw type, Suited for M4 screws<br>Type of mounting device: Adjustable<br>Material: Stainless steel |

### Mounting technology - Rod mounts

|   | Part no. | Designation  | Article         | Description   |
|---|----------|--------------|-----------------|---|
|  | 50117252 | BTU 300M-D12 | Mounting system | Contains: 2x M4 x 25 screw, 2x M4 x 20 screw, 4x position washers<br>Design of mounting device: Mounting system<br>Fastening, at system: For 12 mm rod, Sheet-metal mounting<br>Mounting bracket, at device: Screw type, Suited for M4 screws<br>Type of mounting device: Clampable, Adjustable, Turning, 360°<br>Material: Metal |

#### Note



A list with all available accessories can be found on the Leuze website in the Download tab of the article detailed page.