

## Technical data sheet

### Polarized retro-reflective photoelectric sensor

Part no.: 50141602

PRK318B/2N-5000



#### Contents

- Technical data
- Dimensioned drawings
- Electrical connection
- Diagrams
- Operation and display
- Reflectors & reflective tapes
- Part number code
- Notes
- Further information
- Accessories



## Technical data

### Basic data

Series	318B
Operating principle	Reflection principle

### Optical data

Operating range	0.02 ... 4.5 m (guaranteed operating range), With reflector TK(S) 100x100
Operating range limit	0.02 ... 6 m (typical operating range), With reflector TK(S) 100x100
Light source	LED, Red
Wavelength	620 nm
Transmitted-signal shape	Pulsed
LED group	Exempt group (in acc. with EN 62471)

### Electrical data

Protective circuit	Polarity reversal protection Short circuit protected
--------------------	---

### Performance data

Supply voltage $U_B$	10 ... 30 V, DC, Incl. residual ripple
Residual ripple	0 ... 15 %, From $U_B$
Open-circuit current	0 ... 15 mA

### Outputs

Number of digital switching outputs	2 Piece(s)
-------------------------------------	------------

#### Switching outputs

Type	Digital switching output
Voltage type	DC
Switching current, max.	100 mA
Switching voltage	high: $\geq(U_B - 2.5V)$ low: $\leq 2.5 V$

#### Switching output 1

Switching element	Transistor, NPN
Switching principle	Light switching

#### Switching output 2

Switching element	Transistor, NPN
Switching principle	Dark switching

### Time behavior

Switching frequency	500 Hz
Response time	1 ms
Readiness delay	300 ms

### Connection

Number of connections	1 Piece(s)
-----------------------	------------

#### Connection 1

Function	Signal OUT Voltage supply
Type of connection	Cable
Cable length	5,000 mm
Sheathing material	PUR
Cable color	Black
Number of conductors	4 -wire
Wire cross section	0.2 mm <sup>2</sup>

### Mechanical data

Dimension ( $\varnothing$ x L)	18 mm x 46 mm
Thread size	M18 x 1 mm
Housing material	Plastic
Plastic housing	ABS
Lens cover material	Plastic
Net weight	120 g
Housing color	Black Red

### Operation and display

Type of display	LED
Number of LEDs	1 Piece(s)

### Environmental data

Ambient temperature, operation	-40 ... 60 °C
Ambient temperature, storage	-40 ... 70 °C

### Certifications

Degree of protection	IP 67
Protection class	III
Approvals	c UL US
Standards applied	IEC 60947-5-2

### Classification

Customs tariff number	85365019
ECLASS 5.1.4	27270902
ECLASS 8.0	27270902
ECLASS 9.0	27270902
ECLASS 10.0	27270902
ECLASS 11.0	27270902
ECLASS 12.0	27270902
ECLASS 13.0	27270902
ECLASS 14.0	27270902
ECLASS 15.0	27270902
ECLASS 16.0	27270902
ETIM 5.0	EC002717
ETIM 6.0	EC002717
ETIM 7.0	EC002717
ETIM 8.0	EC002717
ETIM 9.0	EC002717
ETIM 10.0	EC002717
UNSPSC 26.08	39121528

## Dimensioned drawings

All dimensions in millimeters

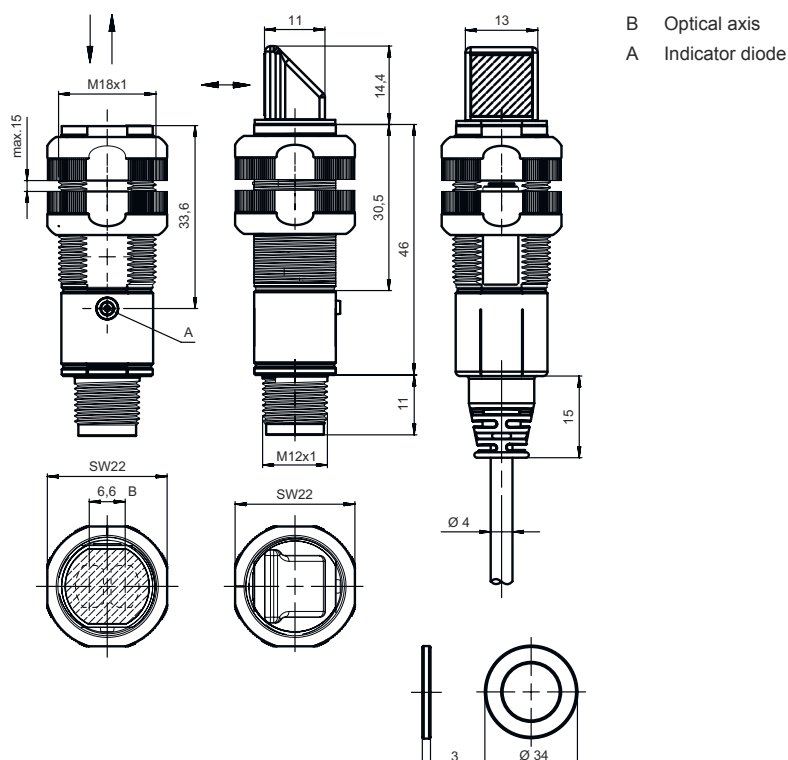

## Electrical connection

### Connection 1

Function	Signal OUT Voltage supply
Type of connection	Cable
Cable length	5,000 mm
Sheathing material	PUR
Cable color	Black
Number of conductors	4 -wire
Wire cross section	0.2 mm <sup>2</sup>

### Conductor color

### Conductor assignment

Brown	V+
White	OUT 2
Blue	GND
Black	OUT 1

## Diagrams

Typ. response behavior (TK 100x100)

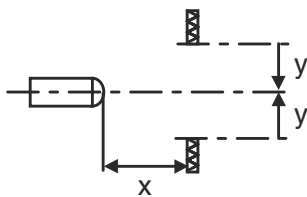
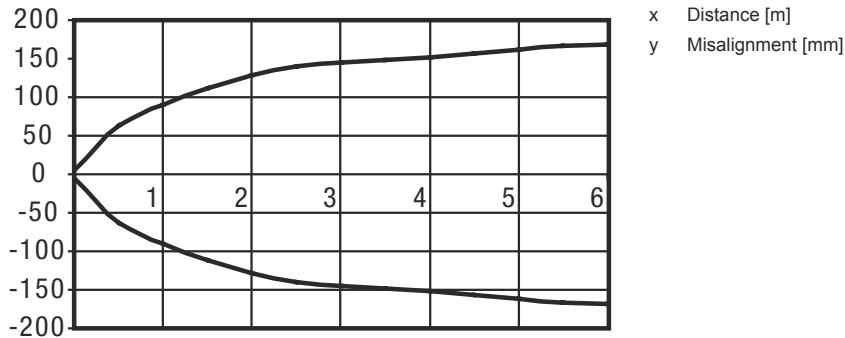

Typ. function reserve (axial model)

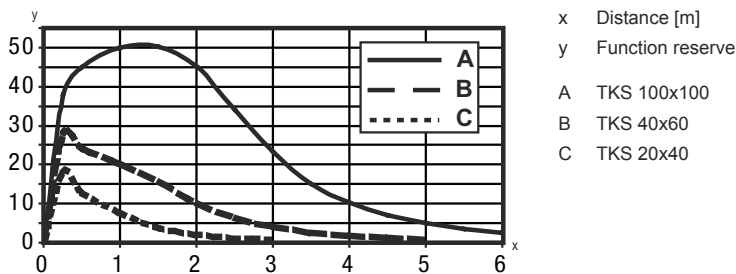

## Operation and display

LED	Display	Meaning
1	Green, continuous light	Operational readiness
	Yellow, continuous light	Light path free
	Yellow, flashing	No function reserve

## Reflectors & reflective tapes

Part no.	Designation	Operating range Operating range limit	Description
50108300	REF 4-A-50x50	0.08 ... 1.4 m 0.08 ... 2 m	Design: Rectangular Reflective surface: 50 mm x 50 mm Material: Plastic Chemical designation of the material: PMMA Fastening: Self-adhesive



## Reflectors & reflective tapes

	Part no.	Designation	Operating range Operating range limit	Description
	50003192	TK 100x100	0.02 ... 4.5 m 0.02 ... 6 m	Design: Rectangular Triple reflector size: 4 mm Reflective surface: 96 mm x 96 mm Material: Plastic Base material: Plastic Chemical designation of the material: PMMA8N Fastening: Rear side can be glued
	50003189	TK 30x50	0.03 ... 1.9 m 0.03 ... 2.5 m	Design: Rectangular Triple reflector size: 4 mm Reflective surface: 29 mm x 45 mm Material: Plastic Base material: Plastic Chemical designation of the material: PMMA8N Fastening: Rear side can be glued
	50024127	TK 82.2	0.05 ... 3.6 m 0.05 ... 4.5 m	Design: Round Triple reflector size: 4 mm Reflective surface, diameter: 79 mm Material: Plastic Base material: Plastic Chemical designation of the material: PMMA8N Fastening: Through-hole mounting, Rear side can be glued
	50022816	TKS 100X100	0.02 ... 4.5 m 0.02 ... 6 m	Design: Rectangular Triple reflector size: 4 mm Reflective surface: 96 mm x 96 mm Material: Plastic Base material: Plastic Chemical designation of the material: PMMA8N Fastening: Through-hole mounting, Adhesive
	50081283	TKS 20X40	0.04 ... 1.6 m 0.04 ... 2.2 m	Design: Rectangular Triple reflector size: 2.3 mm Reflective surface: 16 mm x 38 mm Material: Plastic Base material: Plastic Chemical designation of the material: PMMA8N Fastening: Through-hole mounting, Adhesive
	50023525	TKS 30X50	0.03 ... 1.9 m 0.03 ... 2.5 m	Design: Rectangular Triple reflector size: 3 mm Reflective surface: 27 mm x 44 mm Material: Plastic Base material: Plastic Chemical designation of the material: PMMA8N Fastening: Through-hole mounting, Adhesive
	50040820	TKS 40X60	0.02 ... 3 m 0.02 ... 4 m	Design: Rectangular Triple reflector size: 4 mm Reflective surface: 37 mm x 56 mm Material: Plastic Base material: Plastic Chemical designation of the material: PMMA8N Fastening: Through-hole mounting, Adhesive

## Part number code

Part designation: XXX318BY-AAAF.BB/CC-DDD

<b>XXX318B</b>	<b>Operating principle</b> PRK: Retro-reflective photoelectric sensor with polarization filter ET: energetic diffuse reflection sensor FT: diffuse reflection sensor with fading LE: Throughbeam photoelectric sensor receiver LS: throughbeam photoelectric sensor transmitter
<b>Y</b>	<b>Light type</b> n/a: red light I: infrared light
<b>AAAF</b>	<b>Preset range (optional)</b> n/a: operating range acc. to data sheet xxxF: Preset range [mm]
<b>BB</b>	<b>Equipment</b> n/a: axial optics W: 90° angular optics 3: teach-in via button X: reinforced fading
<b>CC</b>	<b>Switching output / function (OUT1 = pin 4, OUT2 = pin 2):</b> 4: PNP transistor output, light switching P: PNP transistor output, dark switching 2: NPN transistor output, light switching N: NPN transistor output, dark switching 9: input for transmitter deactivation (deactivation with HIGH signal) D: Input for transmitter deactivation (deactivation with LOW signal) X: pin not used
<b>DDD</b>	<b>Electrical connection</b> n/a: cable, standard length 2000 mm, 4-wire M12: M12 connector, 4-pin (plug) 5000: cable, standard length 5000 mm, 4-wire 200-M12: cable, length 200 mm with M12 connector, 4-pin, axial (plug)

### Note

	↪ A list with all available device types can be found on the Leuze website at <a href="http://www.leuze.com">www.leuze.com</a> .
--	--

## Notes

<b>Observe intended use!</b>	
	↪ This product is not a safety sensor and is not intended as personnel protection. ↪ The product may only be put into operation by competent persons. ↪ Only use the product in accordance with its intended use.

### For UL applications:

	↪ For UL applications, use is only permitted in Class 2 circuits in accordance with the NEC (National Electric Code). ↪ These proximity switches shall be used with UL Listed Cable assemblies rated 30V, 0.5A min, in the field installation, or equivalent (categories: CYJV/ CYJV7 or PVVA/PVVA7)
--	---

## Further information

- Sum of the output currents for both outputs, 50 mA for ambient temperatures > 40 °C

## Accessories

### Mounting technology - Mounting brackets

	Part no.	Designation	Article	Description
	50113548	BT D18M.5	Mounting bracket	Diameter, inner: 18 mm Design of mounting device: Angle, L-shape Fastening, at system: Through-hole mounting Mounting bracket, at device: Screw type Type of mounting device: Rigid Material: Stainless steel

### Mounting technology - Rod mounts

	Part no.	Designation	Article	Description
	50117490	BTU D18M-D12	Mounting system	Design of mounting device: Mounting system Fastening, at system: Through-hole mounting Mounting bracket, at device: Screw type Type of mounting device: Clampable, Adjustable, Turning, 360° Material: Metal

### Mounting technology - Other

	Part no.	Designation	Article	Description
	50121904 **	BT318B-OM	Fastening	Design of mounting device: Mounting clamp Fastening, at system: Through-hole mounting Mounting bracket, at device: Screw type Type of mounting device: Swiveling, Adjustable, Turning Material: Plastic Shock absorber: No

\*\* Included in delivery contents

#### Note



A list with all available accessories can be found on the Leuze website in the Download tab of the article detailed page.