

Technical data sheet Bar code positioning system

Part no.: 50144059

FBPS 617i 17 SM 100

Contents

- Technical data
- Dimensioned drawings
- Electrical connection
- Diagrams
- Part number code
- Notes
- Accessories



For illustration purposes only



Technical data

Basic data

Series	FBPS 600i
Order guide	ATTENTION! Only bar code tapes from the accessories of the FBPS 600i may be used

Functions

Functions	Safe position detection
-----------	-------------------------

Characteristic parameters

SIL	3, EN 61508
SILCL	3, IEC/EN 62061
Performance Level (PL)	e, ISO / EN ISO 13849-1:2015
PFH _D	< 9.5E-09 per hour
Mission time T _M	20 years, ISO / EN ISO 13849-1:2015
Category	4, ISO / EN ISO 13849-1:2015
MTTF	64 years
Error reaction time	10 ms (configurable)

Optical data

Depth of field	50 ... 170 mm
Light source	Laser, Red
Wavelength	655 nm
Laser class	1, in accordance with IEC 60825-1:2014 (EN 60825-1:2014)
Transmitted-signal shape	Continuous
Light beam exit	Lateral

Measurement data

Measurement range	0 ... 10,000,000 mm
Resolution	0.01 ... 1 mm
Reproducibility (1 sigma)	0.15 mm
Measurement value output	1 ms
Max. traverse rate	10 m/s

Electrical data

Protective circuit	Polarity reversal protection Short circuit protected
--------------------	---

Performance data

Supply voltage U _B	24 V, DC, -25 ... 25 %
Current consumption, max.	350 ... 400 mA
Power consumption, max.	8.5 W

Inputs

Number of digital switching inputs	1 Piece(s)
------------------------------------	------------

Switching inputs

Type	Digital switching input, configurable (not safe)
------	--

Outputs

Number of digital switching outputs	1 Piece(s)
-------------------------------------	------------

Switching outputs

Type	Digital switching output, configurable (not safe)
------	---

Interface

Type	2-channel SSI with CRC
------	------------------------

SSI

Function	Process
Clock frequency	80 ... 800 kHz
Data bit	Adjustable

Service interface

Type	USB
------	-----

USB

Function	Configuration/parameterization via integrated web server Service
----------	---

Connection

Number of connections	4 Piece(s)
Plug outlet	Lateral

Connection 1

Function	Functional earth (FE) Signal IN Signal OUT Voltage supply
----------	--

Type of connection	Connector
Designation on device	XD1 PWR
Thread size	M12
Type	Male
Material	Metal
No. of pins	5 -pin
Encoding	A-coded

Connection 2

Function	SSI channel A
Type of connection	Connector
Thread size	M12
Type	Male
Material	Metal
No. of pins	5 -pin
Encoding	B-coded

Connection 3

Function	SSI channel B
Type of connection	Connector
Thread size	M12
Type	Male
Material	Metal
No. of pins	5 -pin
Encoding	B-coded

Connection 4

Function	Service interface
Type of connection	USB
Connector type	USB 2.0 Mini-B

Technical data

Mechanical data

Design	Cubic
Dimension (W x H x L)	116.3 mm x 112.5 mm x 51.5 mm
Housing material	Metal
Metal housing	Diecast aluminum
Lens cover material	Glass
Net weight	540 g
Housing color	Silver Yellow
Type of fastening	Dovetail grooves Fastening on back Mounting thread Via optional mounting device

Operation and display

Type of display	LED
Type of configuration	Via web browser

Environmental data

Ambient temperature, operation	-5 ... 60 °C
Ambient temperature, storage	-35 ... 70 °C
Relative humidity (non-condensing)	90 %

Certifications

Degree of protection	IP 65, EN 60529 with various connectors or screwed-on caps
Protection class	III
Certifications	c TÜV NRTL US CSA TÜV Süd UL

Classification

Customs tariff number	84719000
ECLASS 5.1.4	27280190
ECLASS 8.0	27280190
ECLASS 9.0	27280190
ECLASS 10.0	27280190
ECLASS 11.0	27280190
ECLASS 12.0	27280106
ECLASS 13.0	27280106
ECLASS 14.0	27280106
ETIM 5.0	EC001825
ETIM 6.0	EC001825
ETIM 7.0	EC001825
ETIM 8.0	EC001825
ETIM 9.0	EC001825

Dimensioned drawings

All dimensions in millimeters

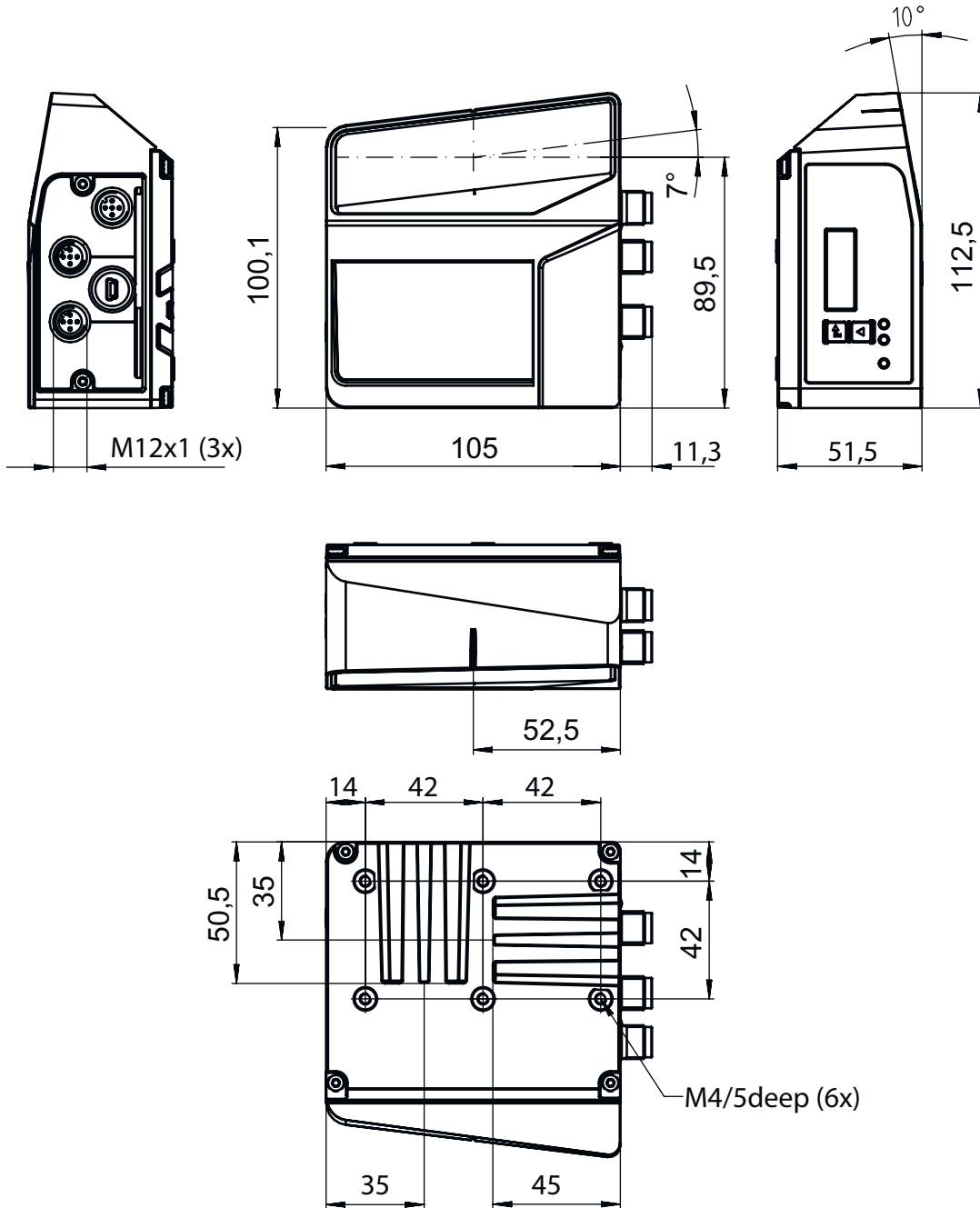

Electrical connection

Connection 1

XD1 PWR

Function

Functional earth (FE)

Signal IN

Signal OUT

Voltage supply

Electrical connection

Connection 1

XD1 PWR

Type of connection	Connector
Thread size	M12
Type	Male
Material	Metal
No. of pins	5 -pin
Encoding	A-coded

Pin	Pin assignment
-----	----------------

1	VIN
2	SWO 1
3	GNDIN
4	SWIN 1
5	FE

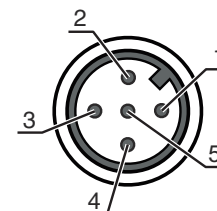

Connection 2

X1 SSI1

Function	SSI channel A
Type of connection	Connector
Thread size	M12
Type	Male
Material	Metal
No. of pins	5 -pin
Encoding	B-coded

Pin	Pin assignment
-----	----------------

1	DATA+
2	DATA-
3	CLK+
4	CLK-
5	FE

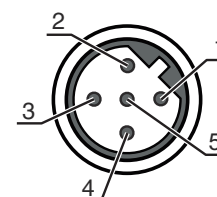

Connection 3

X2 SSI2

Function	SSI channel B
Type of connection	Connector
Thread size	M12
Type	Male
Material	Metal
No. of pins	5 -pin
Encoding	B-coded

Pin	Pin assignment
-----	----------------

1	DATA+
2	DATA-
3	CLK+
4	CLK-
5	FE

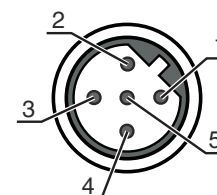

Connection 4

XF0 SERVICE

Function	Service interface
Type of connection	USB
Connector type	USB 2.0 Mini-B

Electrical connection

Pin	Pin assignment
1	VB
2	D-
3	D+
4	ID
5	GND

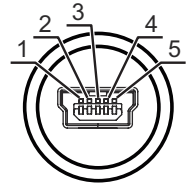

Diagrams

Reading field curve

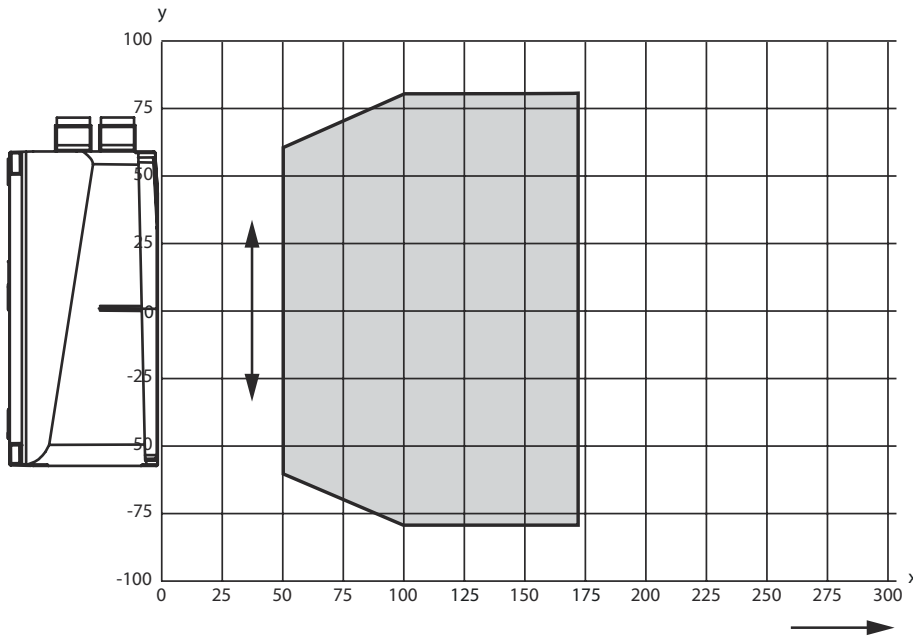

x Reading field distance [mm]
y Reading field width [mm]

Part number code

Part designation: **FBPS 6XXi WW SM XXX Y Z**

FBPS	Operating principle FBPS: Fail-safe bar code positioning system
6XXi	Series/interface (integrated fieldbus technology) 607i: 2-channel standard SSI 617i: 2-channel SSI with CRC
WW	Series/interface (integrated fieldbus technology) 07i: 2-channel standard SSI 17i: 2-channel SSI with CRC
SM	Scanning principle / optics S: line scanner (single line) M: Medium Density (medium distance)

Part number code

XXX	Plug outlet 100: lateral 110: bottom
YZ	Special equipment n/a: no special equipment D: With display H: With heating

Note



A list with all available device types can be found on the Leuze website at www.leuze.com.

Notes

Observe intended use!



The protection of personnel and the device cannot be guaranteed if the device is operated in a manner not complying with its intended use.

- Only use the product in accordance with its intended use.
- Leuze electronic GmbH + Co. KG is not liable for damages caused by improper use.
- Before commissioning the device, read the operating instructions. Knowledge of the operating instructions is an element of proper use.

ATTENTION! LASER RADIATION – CLASS 1 LASER PRODUCT





The device satisfies the requirements of IEC/EN 60825-1:2014 safety regulations for a product of **laser class 1** and complies with 21 CFR 1040.10 except for conformance with IEC 60825-1 Ed. 3., as described in Laser Notice No. 56, dated May 8, 2019.

- Observe the applicable statutory and local laser protection regulations.
- The device must not be tampered with and must not be changed in any way. There are no user-serviceable parts inside the device. Repairs must only be performed by Leuze electronic GmbH + Co. KG.

Accessories

Connection technology - Connection cables

	Part no.	Designation	Article	Description
	50104172	KB SSI/IBS-2000-BA	Connection cable	Suitable for interface: SSI, Interbus-S Connection 1: Connector, M12, Axial, Female, B-coded, 5 -pin Connector, LED: No Connection 2: Open end Shielded: Yes Cable length: 2.000 mm Sheathing material: PUR
	50133859	KD S-M12-5A-P1-020	Connection cable	Connection 1: Connector, M12, Axial, Female, A-coded, 5 -pin Connector, LED: No Connection 2: Open end Shielded: Yes Cable length: 2.000 mm Sheathing material: PUR

Accessories

	Part no.	Designation	Article	Description
	50133839	KD U-M12-5A-P1-020	Connection cable	Connection 1: Connector, M12, Axial, Female, A-coded, 5 -pin Connector, LED: No Connection 2: Open end Shielded: No Cable length: 2.000 mm Sheathing material: PUR

Connection technology - Connectors

	Part no.	Designation	Article	Description
	50020501	KD 095-5A	Connector	Connection: Connector, M12, Axial, Female, A-coded, 5 -pin



Mounting technology - Mounting brackets

	Part no.	Designation	Article	Description
	50121433	BT 300 W	Mounting device	Design of mounting device: Angle, L-shape Fastening, at system: Through-hole mounting Mounting bracket, at device: Screw type Type of mounting device: Adjustable Material: Metal

Mounting technology - Other

	Part no.	Designation	Article	Description
	50124941	BTU 0300M-W	Mounting device	Fastening, at system: Through-hole mounting Mounting bracket, at device: Clampable, Groove mounting, Suited for M4 screws Material: Metal Shock absorber: No

Bar code tape

	Part no.	Designation	Article	Description
	50144173	BCB G30 H25 L010	Bar code tape	Dimensions: 25 mm x 10,000 mm Grid dimension: 30 mm
	50104792	BCB G30 H47 L010	Bar code tape	Dimensions: 47 mm x 10,000 mm Grid dimension: 30 mm

Accessories

Services

	Part no.	Designation	Article	Description
	S981001	CS10-S-110	Start-up support	Details: Performed at location of customer's choosing, duration: max. 10 hours. Conditions: Devices and connection cables are already mounted, price not including travel costs and, if applicable, accommodation expenses.
	S981005	CS10-T-110	Product training	Details: Location and content to be agreed upon, duration: max. 10 hours. Conditions: Price not including travel costs and, if applicable, accommodation expenses.

Note



A list with all available accessories can be found on the Leuze website in the Download tab of the article detailed page.