

## Technical data sheet

### Single light beam safety device receiver

Part no.: 50126329

SLE46C-70.K4/4P

#### Contents

- Technical data
- Dimensioned drawings
- Electrical connection
- Operation and display
- Suitable transmitters
- Notes
- Further information
- Accessories



For illustration purposes only



## Technical data

### Basic data

Series	46C
--------	-----

### Functions

Functions	Alignment indicator
	Diagnostic output

### Characteristic parameters

Type	4, IEC/EN 61496, in combination with MSI-TRMB safety relay
SIL	3, IEC 61508, in combination with MSI-TRMB safety relay
SILCL	3, IEC/EN 62061, in combination with MSI-TRMB safety relay
Performance Level (PL)	e, EN ISO 13849-1:2008, In combination with MSI-TRMB safety relay
MTTF <sub>d</sub>	900 years, EN ISO 13849-1
Mission time T <sub>M</sub>	20 years, EN ISO 13849-1
Category	4, EN ISO 13849:2008, In combination with MSI-TRMB safety relay

### Electrical data

Protective circuit	Polarity reversal protection
	Short circuit protected

### Performance data

Supply voltage U <sub>B</sub>	24 V, DC, -20 ... 20 %, Incl. residual ripple
Residual ripple	10 %, From U <sub>B</sub>
Open-circuit current	0 ... 15 mA

### Outputs

Number of digital switching outputs	2 Piece(s)
-------------------------------------	------------

### Switching outputs

Switching voltage high, min.	22 V
Switching voltage low, max.	2 V
Switching voltage, type.	23 V
Voltage type	DC
Switching current, max.	100 mA
Switching voltage	high: $\geq(U_B - 2V)$
	low: $\leq 2 V$

### Switching output 1

Assignment	Connection 1, conductor 2
Switching element	Transistor, PNP
Switching principle	Dark switching
Function	Diagnostic output

### Switching output 2

Assignment	Connection 1, conductor 4
Switching element	Transistor, PNP
Switching principle	Light switching
Function	Switching output

### Time behavior

Switching frequency	250 Hz
Response time	2.5 ms
Readiness delay	300 ms

### Connection

Number of connections	1 Piece(s)
-----------------------	------------

### Connection 1

Function	Signal OUT
	Voltage supply
Type of connection	Cable
Cable length	2,000 mm
Sheathing material	PUR
Number of conductors	4 -wire
Wire cross section	0.21 mm <sup>2</sup>

### Mechanical data

Design	Cubic
Dimension (W x H x L)	20.5 mm x 76.3 mm x 44 mm
Housing material	Plastic
Plastic housing	PC-PBT
Lens cover material	Plastic / PMMA
Net weight	100 g
Housing color	Yellow
Type of fastening	Through-hole mounting
Compatibility of materials	ECOLAB

### Operation and display

Type of display	LED
Number of LEDs	2 Piece(s)

### Environmental data

Ambient temperature, operation	-30 ... 60 °C
Ambient temperature, storage	-30 ... 70 °C

### Certifications

Degree of protection	IP 67
	IP 69K
Protection class	III, Rating voltage 50V
Approvals	c UL US
Standards applied	IEC 60947-5-2, IEC/EN 61496

### Classification

Customs tariff number	85365019
ECLASS 5.1.4	27272701
ECLASS 8.0	27272701
ECLASS 9.0	27272701
ECLASS 10.0	27272701
ECLASS 11.0	27272701
ECLASS 12.0	27272701
ECLASS 13.0	27272701
ECLASS 14.0	27272701
ECLASS 15.0	27272701
ECLASS 16.0	27272701
ETIM 5.0	EC001831
ETIM 6.0	EC001831
ETIM 7.0	EC001831
ETIM 8.0	EC001831
ETIM 9.0	EC001831
ETIM 10.0	EC001831
UNSPSC 26.08	32151804

## Dimensioned drawings

All dimensions in millimeters

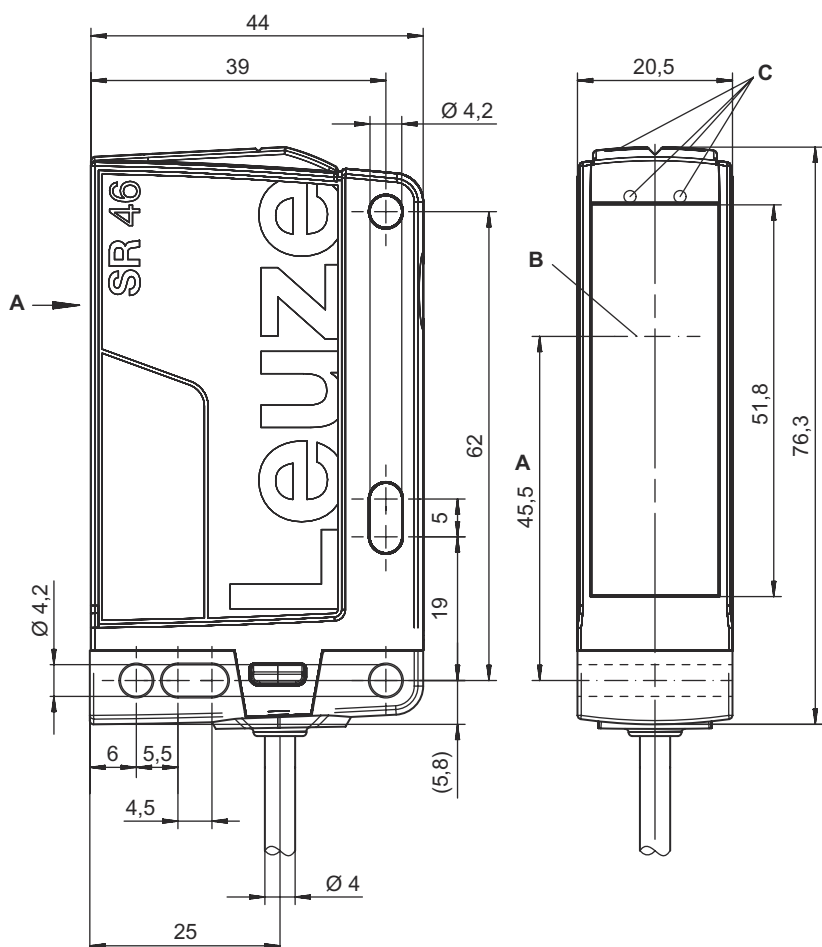

- A Optical axis
- B Transmitter and receiver
- C Green/yellow indicator diodes

## Electrical connection

### Connection 1

Function	Signal OUT
	Voltage supply
Type of connection	Cable
Cable length	2,000 mm
Sheathing material	PUR
Cable color	Black
Number of conductors	4 -wire
Wire cross section	0.21 mm <sup>2</sup>

### Conductor color

### Conductor assignment

Brown	+24 V
White	Diagnosis
Blue	GND
Black	OUT

## Operation and display

LED	Display	Meaning
1	Green, continuous light	Ready
2	Yellow, continuous light	Light path free

## Suitable transmitters

	Part no.	Designation	Article	Description
	50126547	SLS46C-70.K48	Single light beam safety device transmitter	Special version: Activation input Operating range: 5 ... 70 m Operating range limit: 5 ... 80 m Light source: LED, Red Response time: 2.5 ms Connection: Cable, 2,000 mm, PUR

## Notes

 **Observe intended use!**

 The product may only be put into operation by competent persons.  
Only use the product in accordance with its intended use.

**ATTENTION!**

 The SLS46CK4 safety sensors are a type 4 AOPD only in combination with the MSI-TRM safety relays.  
For mounting, electrical connection and operation, the operating instructions of the MSI-TRM safety relays are to be observed.

**For UL applications:**



 Certification: UL 508, C22.2 No.14-13  
Only for use in "class 2" circuits  
These proximity switches shall be used with UL Listed Cable assemblies rated 30V, 0.5A min, in the field installation, or equivalent (categories: CYJV/ CYJV7 or PVVA/PVVA7)

## Further information

- Light source: Average life expectancy 100,000h at an ambient temperature of 25 °C

## Accessories

### Connection technology - Connection unit

	Part no.	Designation	Article	Description
	547931	MSI-TRMB-01	Safety relay	
	547932	MSI-TRMB-02	Safety relay	

### Mounting technology - Mounting brackets

	Part no.	Designation	Article	Description
	50105315	BT 46	Mounting device	Design of mounting device: Angle, L-shape Fastening, at system: Through-hole mounting Mounting bracket, at device: Screw type Type of mounting device: Rigid Material: Metal

### Muting - Mounting systems

	Part no.	Designation	Article	Description
	50117252	BTU 300M-D12	Mounting system	Contains: 2x M4 x 25 screw, 2x M4 x 20 screw, 4x position washers Design of mounting device: Mounting system Fastening, at system: For 12 mm rod, Sheet-metal mounting Mounting bracket, at device: Screw type, Suited for M4 screws Type of mounting device: Clampable, Adjustable, Turning, 360° Material: Metal

#### Note



A list with all available accessories can be found on the Leuze website in the Download tab of the article detailed page.